

US VERSION

# POLARIS SPORTSMAN

## 2021

ACCESSORIES + APPAREL





# FORGE YOUR OWN PATH



Sportsman is legendary, giving you the ability to ride harder, go further and do more than any other ATV. From the farm yards to the scenic trails, the Polaris Sportsman line-up is chosen by more ATV owners than any other in the industry.

# 2021 LINEUP

SEE THE FULL LINEUP AT [POLARIS.COM/SPORTSMAN](https://www.polaris.com/sportsman)

## NEW FOR MODEL YEAR 2021

P. 02

ACCESSORY PACKAGES: P. 02

NEW GENERATION OF SPORTSMAN 450 AND 570: P. 04

## 450 / 570

P. 14

### RECREATION & UTILITY



SPORTSMAN 450 H.O. (EPS)



SPORTSMAN 570 (EPS/EBS)



SPORTSMAN TOURING 570 (EPS/EBS)



SPORTSMAN 570 HUNTER EDITION

### WORK



SPORTSMAN 570 6X6



SPORTSMAN 570 X2

## 850 / XP 1000 / XP 1000 S

P. 26

### RECREATION & UTILITY



SPORTSMAN 850



SPORTSMAN XP 1000



SPORTSMAN XP 1000 S



SPORTSMAN TOURING 850 / XP 1000

### HUNT



SPORTSMAN XP 1000 HUNTER EDITION

### MUD



SPORTSMAN 850 / XP 1000 HIGH LIFTER EDITION

### TOURING

## SCRAMBLER 850 / XP 1000 S

P. 34

### SPORT PERFORMANCE



SCRAMBLER 850



SCRAMBLER XP 1000 S

## YOUTH

P. 36



OUTLAW 70



POLARIS ACE 150 EFI

# CONTENTS

## NEW FOR MODEL YEAR 2021 02

## WINCHES 12

## 450 / 570 14

WINCHES, PROTECTION & RACKS	16
COMFORT, AUDIO & STORAGE	18
WINDSHIELDS	20
570 6X6, 570 TOURING & 570 X2	22

## 850 / XP 1000 / XP 1000 S 26

WINCHES, RACKS & PROTECTION	28
COMFORT, AUDIO & STORAGE	30
WINDSHIELDS	32

## SCRAMBLER 850 / XP 1000 S 34

WINCHES, RACKS/STORAGE & PROTECTION	34
-------------------------------------	----

## ACE 150 / OUTLAW 70 YOUTH 36

## COMMON ACCESSORIES 38

WHEELS & TIRES	38
TRACKS	44
GLACIER® PLOW SYSTEMS	46
LIGHTING	48
HUNT	50
POLARIS NORTHSTAR COOLERS	52

## PARTS & GARAGE 54

MAINTENANCE	54
OIL & LUBRICANTS	56
MAINTENANCE FLUIDS	58
SERVICE PARTS	60
HD PARTS	62
BATTERY & TIRE SEALANT	64
VEHICLE CARE & TRAILERING	66
POLARIS POWER	68

## APPAREL & HELMETS 72

OUTERWEAR & PROTECTION	72
LIFESTYLE APPAREL & CAPS	78
CAMO & GIFTS	80



SHOP ALL SPORTSMAN ACCESSORIES AT [POLARIS.COM/ShopSPORTSMAN](https://www.polaris.com/ShopSPORTSMAN)



# MODEL YEAR 2021

TAKE YOUR SPORTSMAN PACKAGES AND LIMITED EDITIONS TO THE NEXT LEVEL

**GO FURTHER  
WITH YOUR SPORTSMAN  
FACTORY-INSTALLED PACKAGE  
OR LIMITED EDITION**

Take your Sportsman to the next level and continue to customize with these accessory add-ons.  
[Polaris.com/SportsmanPackages](https://Polaris.com/SportsmanPackages)

SPORTSMAN 570 EPS TRAIL EDITION  
+ POPULAR ADD-ONS



**TRAIL PACKAGE &  
ULTIMATE TRAIL  
LIMITED EDITION**

**MOST POPULAR ADD-ONS**

- Racks P. 17
- Storage P. 19
- Windshields P. 20
- Wheels & Tires P. 38

SPORTSMAN 570 EPS UTILITY EDITION  
+ POPULAR ADD-ONS



**UTILITY PACKAGE  
AND HD UTILITY  
LIMITED EDITION**

**MOST POPULAR ADD-ONS**

- Storage P. 19
- Windshields P. 20
- Winches P. 12
- Wheels & Tires P. 38



# SPORTSMAN 450 AND 570 REBORN

WIDE SELECTION OF ACCESSORIES TO CHOOSE FROM TO  
CUSTOMIZE YOUR EXPERIENCE

TRUE ON DEMAND  
ALL-WHEEL DRIVE

BOLDER STYLE,  
BIGGER VALUE

INDUSTRY-LEADING ACCESSORIES  
ENGINEERED TO DO MORE  
FOR EVERY KIND OF JOB BIG OR SMALL

## SUPERIOR INTEGRATION

ESSENTIAL ACCESSORIES RIGHT  
FROM THE FACTORY TO MAKE WORK  
EASIER TO GET MORE DONE.

PRO PRO HEAVY DUTY SERIES  
WINCHES

#GLACIER  
PLOW SYSTEM

Winches P. 12  
Plows P. 46



## ULTIMATE PROTECTION

VEHICLE AND RIDER PROTECTION  
AGAINST OBSTACLES ON THE TRAIL.

LOCK & RIDE

Protection P. 16  
Windshields P. 20  
Handguards P. 18



## STORAGE VERSATILITY

VERSATILITY, ADDED STORAGE,  
AND LIMITLESS CUSTOMIZATION  
WITH EASY INSTALLATION.

LOCK & RIDE

Storage P. 19  
Racks P. 17  
Rack Extenders P. 17





**KEEP YOUR**  
**STANDARDS**  
**HIGH. WE DO.**

**DESIGNED**



Designed by the same people who designed your vehicle.

**TESTED**

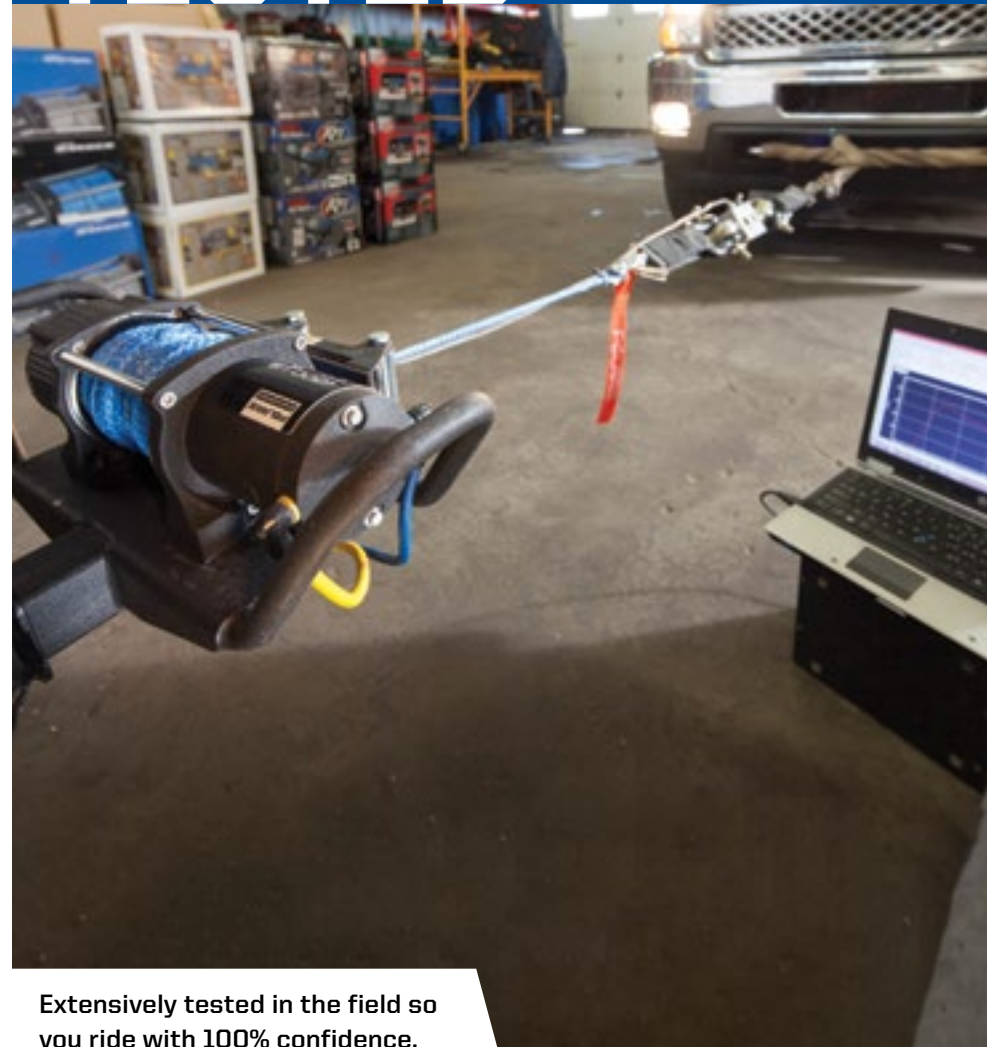

Extensively tested in the field so you ride with 100% confidence.

**TRUSTED**



**ACCESSORIES  
BACKED BY A**



**WARRANTY**

65 years in the business.  
The #1 name in Off-Road.

**WE HOLD OUR  
PARTNERS TO THE  
SAME STANDARDS**



**WHEELS, TIRES & LIGHTING DESIGNED WITH  
POLARIS TO MAXIMIZE PERFORMANCE**

P. 38, 48



**A GLOBAL LEADER IN AUDIO INNOVATION,  
DESIGN & ENGINEERING**

P. 19, 31



**PRODUCTS SO GOOD THEY REPLACE  
OR REPAIR THEM FOR LIFE**

P. 48



**MAKING PRODUCTS FOR AVID  
SPORTSMEN SINCE 1943**

P. 50



# ENGINEERED

# FOR MORE



Ensuring Polaris Engineered Accessories fit and work in sync with your machine is the most critical phase of testing and validation. With seamless integration, you can trust that any Polaris accessory you install will enhance your interaction beyond your expectations.



## LOCK & RIDE

### CARGO VERSATILITY

Lock & Ride mounting locations allow for limitless customization to let you work the way you want.

**P. 19, 30**

## PRO PRO HEAVY DUTY SERIES

### WINCHES

#### INTEGRATED WINCH MOUNT & PRE-WIRED

Designated mounting points and pre-wired connectors ensure a perfect fit and the strongest place to attach the Polaris Engineered winch - the most dependable winch for your Sportsman. With wiring built right into the vehicle, we made this the easiest Sportsman winch ever made to install.

**P. 12**

## GLACIER

### PLOW SYSTEM

#### INTEGRATED PLOW MOUNT

The attachment points for the best-in-class Glacier® Plow System are integrated right at the factory and feature an innovative drive-up and go installation process.

**P. 46**



# SUPERIOR

# INTEGRATION

# POLARIS ENGINEERED

Right from the factory, your vehicle is built to make essential accessories like winches and plows easy to use day-in and day-out. Mounting brackets are designed into the oversized factory bumper and wiring is routed securely and properly. When it comes to Sportsman, Polaris Engineered Accessories make work easier so you can get more done.

**PRO** PRO HEAVY DUTY SERIES

**HID** HEAVY DUTY SERIES



WINCHES

PLOWS



**GLACIER**  
PLOW SYSTEM

P. 46



**GLACIER** FEATURES

- ✓ Easily engage and disengage the plow system from your Polaris Sportsman
- ✓ No loss of factory ground clearance when not plowing
- ✓ Don't have to crawl under the machine to release the plow blade from the vehicle
- ✓ No trimming of vehicle plastic or fascia required to mount plow or winch

**WINCHES** P. 12

[POLARIS.COM/WINCHES](http://POLARIS.COM/WINCHES)

**POLARIS WINCH FEATURES**



✓ Tested **1,200+** pulls at max load, it works when you need it to



✓ Built to withstand **-20° F** temperatures



✓ Sealed motor & heavy duty gears **OPERATE FULLY SUBMERGED UNDERWATER**



✓ **MILITARY** tested & approved

**PRE-WIRED CHASSIS**

Factory-installed wiring makes the controls simple to install. Mount the winch, connect the wires and trust that everything is routed safely, securely, and properly.

**NO NEED TO CUT PANELS**

**FULLY INTEGRATED MOUNT & WIRING**



**25°**

LEFT AND RIGHT

ANGLE YOUR BLADE RIGHT FROM YOUR SEAT



# WINCHES



ADD A PLOW  
P. 46

## WHETHER HARD AT WORK OR ON THE TRAILS, ADD A WINCH TO...

- GET THE JOB DONE RIGHT
- GET YOU ON YOUR WAY FASTER
- BE PREPARED FOR UNEXPECTED SITUATIONS

## WHY POLARIS?

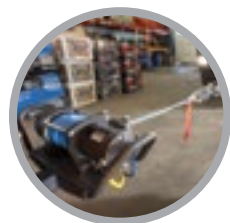

TESTED **1,200+**  
PULLS AT MAX LOAD



BUILT TO WITHSTAND  
**-20° F** TEMPERATURES



OPERATES FULLY  
SUBMERGED



MILITARY  
TESTED & APPROVED

## REPLACEMENT PART



### REPLACEMENT STEEL CABLE

- 2,500 Winch Series - 50 ft.

» 2878890 • \$41<sup>99</sup>



### RECOVERY STRAP

- 2" x 30' (18,000 lb)
- Comes with carry bag

» 2884033 • \$54<sup>99</sup>

## FEATURES

## ALL POLARIS ENGINEERED WINCHES COME WITH:



1. Set dial to FREE SPOOL (N) to attach winch hook
2. Set dial to PULL (L) for winch mode
3. Set dial to ROPE RECOVERY (H) for 5x faster rope recovery

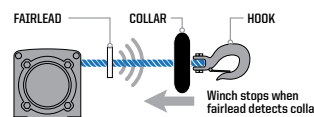

Stops winch at end of pull to prevent driveline stress and plow overlifting



- Lightweight & Easy to Handle
- Superior Flexibility & Strength
- 50 ft. Long



50 ft. range wireless remote control with unique code for interference-free operation

## MODEL

450 H.O. '21  
570 '21

450 H.O. '16-20  
570 '14-20  
X2 570 '15-21  
TOURING 570 '14-21  
6X6 570 '17-21

850 '12-21  
XP 1000 '15-21  
TOURING XP 1000 '15-21  
TOURING 850 '15-21  
SCRAMBLER 850 '14-21

XP 1000 S '20-21  
SCRAMBLER XP 1000 S '20-21

## PRO PRO HEAVY DUTY SERIES TOP-OF-THE-LINE FEATURES



## H-D HEAVY DUTY SERIES BUILT FOR THE OFF-ROAD



## PRO PRO HEAVY DUTY SERIES

## H-D HEAVY DUTY SERIES



WARRANTY

- ✓ INTEGRATED WIRING, MOUNT, PREASSEMBLED
- ✓ HOOK WITH STRAP
- ✓ CUT STEEL GEARS & SEALED DRIVETRAIN
- ✓ SEALED PERMANENT MAGNET MOTOR



WITH ALUMINUM FAIRLEAD



NOT AVAILABLE

ADD AUTO STOP TECHNOLOGY WINCH UPGRADE

2881693 • \$104<sup>99</sup>

SYNTHETIC ROPE REQUIRED



WITH STEEL ROLLER FAIRLEAD

ADD SYNTHETIC ROPE

TOP SELLER

2878888 • \$79<sup>99</sup>



ADD WIRELESS WINCH REMOTE

2879316 • \$134<sup>99</sup>



3,500 LB.  
with Synthetic Rope

**NEW**  
2884834  
\$549<sup>99</sup>

3,500 LB.  
with Synthetic Rope

**NEW**  
2884833  
\$469<sup>99</sup>

2,500 LB.  
with Steel Cable

**NEW**  
2884832  
\$399<sup>99</sup>

TOP SELLER  
2880434  
\$469<sup>99</sup>

TOP SELLER  
2880432  
\$399<sup>99</sup>

2882241  
\$549<sup>99</sup>

TOP SELLER  
2880435  
\$469<sup>99</sup>

2880433  
\$399<sup>99</sup>

2883580  
\$549<sup>99</sup>



COMFORT ESSENTIALS



Pro HD 3,500 lb. Winch	P. 16	Rear Brushguard	P. 16	Rigid® D-Series Pro Driving LED Light	P. 48
Trail Brushguard	P. 16	Rear Rack Extender	P. 17	Rear Power Harness	P. 18
LED Light Kit	P. 18	Pro Armor Wheel & Tire Set: Dual Threat/Buckle Accent	P. 43	Handguards - Black	P. 18
Audio Storage Box	P. 19	Lug Nuts	P. 43	Handguard Mount	P. 18
Audio Storage Box Remote	P. 19				

WORK HARD AND GET IT DONE with Polaris Engineered Accessories. Find everything you need to outfit your trusted partner for the task at hand.

WORKER



2,500 lb. Winch	P. 16	Rear Rack Extender	P. 17	Open Cargo Box	P. 19
HD Front Brushguard	P. 16	Pro Armor Wheel & Tire Set: Harvester/Shackle - Matte Black	P. 43	Front Utility Rack	P. 17
Body Armor	P. 17	Lug Nuts	P. 43	Rear Utility Rack	P. 17
Rear Brushguard	P. 16	Mid Windshield	P. 20		

ACCESSORIES

WINCHES

450 - 570

850 - XP 1000 - XP 1000 S

SRAMBLER 850 - XP 1000 S

MISC & YOUTH

WHEELS & TIRES

TRACKS & PLOW

LIGHTING

HUNT & COOLERS

HUNTER



Pro HD 3,500 lb. Winch	P. 16	Gun Boot Mount	P. 50	Rear Power Harness	P. 18
HD Front Brushguard	P. 16	Mid Windshield	P. 20	Pro Armor Wheel & Tire Set: Mud XC/Sixr	P. 43
Rear Rack Extender	P. 17	Gun Boot	P. 50	Lug Nuts	P. 43
Hand & Thumb Warmer Kit	P. 18	Rigid® SR-Series 10" Combo LED Light	P. 48		

WINTER



Pro HD 3,500 lb. Winch	P. 16	Hand & Thumb Warmer Kit	P. 18	Rear Power Harness	P. 18
Glacier® Integrated Plow Mount	P. 47	Windshield - Tall	P. 20	HD Front Brushguard	P. 16
Glacier® Pro Lock & Ride Steel ATV Plow Frame, Black	P. 47	Rear Rack Extender	P. 17	Rear Cargo Box	P. 19
Glacier® Pro Plow Blade - 66" Poly	P. 47	Rigid® SR-Series 10" Combo LED Light	P. 48		



# 2021 SPORTSMAN 450 • 570



## WINCHES

### **NEW** POLARIS PRO HD 3,500 LB. WINCH

- Adds 3,500 lbs of pulling capacity with auto stop technology for plowing applications
- New rapid rope recovery design with standard pulling mode and high-speed recovery which recovers open cable 5 times faster than standard speeds with quick and easy installation

» 2884834 • \$549<sup>99</sup>  
570 '21, 450 H.O. '21



INDUSTRY 1<sup>ST</sup> TECHNOLOGY



LEARN MORE ON P. 12

### **NEW** POLARIS HD 3,500 LB. WINCH

- Adds 3,500 lbs of pulling capacity with a quick and easy installation
- Includes all components required for installation plus 50' of 3/16 premium high-strength synthetic rope

» 2884833 • \$469<sup>99</sup>  
570 '21, 450 H.O. '21



### **NEW** POLARIS HD 2,500 LB. WINCH

- Adds 2,500 lbs of pulling capacity with quick and easy installation
- Includes all components required for installation plus 50' of 3/16 high-strength steel cable

» 2884832 • \$399<sup>99</sup>  
570 '21, 450 H.O. '21



NEED A PLOW? SEE P. 46

POLARIS.COM/ShopSPORTSMAN

## PROTECTION

### **NEW** TRAIL BRUSHGUARD



- Provides enhanced protection from brush and debris
- Has designated light bar holes and is compatible with winch and body armor

» 2884844 • \$199<sup>99</sup>  
570 '21, 450 H.O. '21



### **NEW** REAR BRUSHGUARD

- Protect your vehicle from brush, sticks, rocks and light bumps into solid objects
- Made of sturdy 1.25" Steel Tube with a matte black finish

» 2884847 • \$189<sup>99</sup>  
570 '21, 450 H.O. '21



### **NEW** HD FRONT BRUSHGUARD WITH HITCH

- Adds heavy duty protection with a custom look
- Has designated light bar holes and is compatible with winch and body armor
- Standard front receiver hitch for additional functionality

» 2884850 • \$299<sup>99</sup>  
570 '21, 450 H.O. '21



### **NEW** BODY ARMOR – BLACK

- Provides extra protection to your ATV's full body and fenders

» 2884851 • \$259<sup>99</sup>  
570 '21, 450 H.O. '21

Front bumper (2884850 or 2884844) required for installation



### **NEW** SKID PLATE

- Built to be tough from 10mm thick high-density polyethylene

» 2884852 • \$299<sup>99</sup>  
570 '21, 450 H.O. '21

## RACKS



### **NEW** FRONT RACK EXTENDER

- Forms a 3" tall perimeter around the front cargo rack to keep gear secure which maximizes your cargo capabilities
- Durable steel construction provides a sturdy tie down anchor for loose gear

» 2884840 • \$99<sup>99</sup>  
570 '21, 450 H.O. '21



### **NEW** REAR RACK EXTENDER

- Forms a 3" tall perimeter around the rear cargo rack to keep gear secure which maximizes your cargo capabilities
- Durable steel construction provides a sturdy tie down anchor for loose gear
- Compatible with Cargo Boxes and Rear Utility Rack

» 2884841 • \$99<sup>99</sup>  
570 '21, 450 H.O. '21



### **NEW** FRONT UTILITY RACK

- Tubular steel rack that attaches on top of front plastic rack providing protection and multiple tie down points
- 3/4" diameter matte black tube steel

» 2884842 • \$129<sup>99</sup>  
570 '21, 450 H.O. '21



### **NEW** REAR UTILITY RACK

- Replaces rear plastic rack with a strong flat steel rack with integrated tie down points
- Works with all Lock & Ride accessories, rack extenders, and gun mounts

» 2884843 • \$209<sup>99</sup>  
570 '21, 450 H.O. '21



# 2021 SPORTSMAN 450 • 570



## COMFORT



### NEW HAND & THUMB WARMER KIT

- Provides heat to grips and throttle and is easily installed by plugging into pod
- Includes two heated grips and one throttle warmer

» 2885002 • \$99<sup>99</sup>  
570 '21, 450 H.O. '21



### NEW REAR POWER HARNESS

- Provides power to the rear of the ATV for electrical accessories including Rear Audio Storage Box

» 2889070 • \$79<sup>99</sup>  
570 '21, 450 H.O. '21



### HANDGUARDS

<input type="checkbox"/> BRIGHT WHITE	2876883	\$30 <sup>99</sup>
<input checked="" type="checkbox"/> BLACK	2876846	\$30 <sup>99</sup>
<input checked="" type="checkbox"/> INDY RED	2876845	\$30 <sup>99</sup>

- Handguard Mount (2879380) is required when installing Polaris Handguards
- Does not fit with windshields or handlebar-mounted mirrors

» 2879380 • MOUNT • \$30<sup>99</sup> TOP SELLER  
570 '21, 450 H.O. '21



### NEW HANDLEBAR MOUNTED MIRRORS TOP SELLER

- For added safety on or off the trail
- Sold as a pair
- Does not fit with windshield fairing or handguards

» 2877222 • \$36<sup>99</sup>  
570 '21, 450 H.O. '21



### NEW LED LIGHT KIT

- Upgrade your standard headlights and pod lights to LEDs with this upgrade kit

» 2884859 • \$399<sup>99</sup>  
'570 '21, 450 H.O. '21

## AUDIO



### NEW FALL AVAILABILITY REAR AUDIO STORAGE BOX LOCK & RIDE

- Dual 6" Speakers by Rockford Fosgate® that connect via Bluetooth®
- Mounts easily with Lock & Ride to the rear rack and is compatible with rack extenders, utility rack, and gun mount
- Rest easy knowing that your speakers are protected with a sealed lid container
- Rear power harness required for installation (2889070)

» 2884856 • \$599<sup>99</sup>  
570 '21, 450 H.O. '21



### NEW AUDIO STORAGE BOX REMOTE

- Easily control the volume or switch to the next song on your Rear Audio Storage Box that conveniently mounts to your ATV's handlebars

» 2884987 • \$89<sup>99</sup>  
570 '21, 450 H.O. '21

## STORAGE

### NEW REAR CARGO BOX LOCK & RIDE

- Increase your storage with an extra 21.25 gallons of dry, dust-proof storage
- Mounts easily with Lock & Ride to the rear rack and is compatible with rack extenders, utility rack, and gun mount
- Includes 2 padlock locations

» 2884853 • \$319<sup>99</sup>  
570 '21, 450 H.O. '21



### NEW OPEN CARGO BOX LOCK & RIDE

- Increase your storage with an extra 22 gallons of convenient storage space
- Mounts easily with Lock & Ride to the rear rack and is compatible with rack extenders, utility rack, and gun mount
- Holds 2, 5-gallon buckets with integrated grab handle to make it easy to carry and transport cargo
- 12 convenient tie-down locations to secure cargo

» 2884854 • \$209<sup>99</sup>  
570 '21, 450 H.O. '21



### NEW REAR COOLER BOX LOCK & RIDE

- Increase your storage with an extra 46 quarts of weather resistant cooler storage
- Mounts easily with Lock & Ride to the rear rack and is compatible with rack extenders, utility rack, and gun mount
- Integrated bottle opener and 2 padlock locations

» 2884857 • \$399<sup>99</sup>  
570 '21, 450 H.O. '21





# 2021 SPORTSMAN 450 • 570



## WINDSHIELDS



Tall 18" Clear



Mid 14" Clear



Short 9" Clear

**NEW**

### LOCK & RIDE SPORTSMAN WINDSHIELDS

- Lock & Ride technology allows for easy installation and removal in seconds without tools
- Lock & Ride mounts allow a rider to adjust the height and angle of the windshield
- Poly windshields are flexible, impact-resistant, and provide long-term value over the life of your machine
- Three heights available for whatever coverage you prefer
- Does not work with handguards

SIZE	COLOR	PART #	PRICE
TALL 18"	CLEAR	2884945	\$179 <sup>99</sup>
MID 14"	CLEAR	2884845	\$169 <sup>99</sup>
SHORT 9"	CLEAR	2884946	\$159 <sup>99</sup>

570 '21, 450 H.O. '21



## DO MORE

### LIGHTING SEE P. 48



### HUNT SEE P. 50



### PLOWS SEE P. 46



### WHEELS & TIRES SEE P. 38





# 2014-2021 SPORTSMAN 570 6X6 570 TOURING 570 X2



## COMFORT



### HAND WARMERS TOP SELLER

» 2877363 • \$59<sup>99</sup>  
X2 570 '15-21, TOURING 570 '14-21, 6X6 570 '17-21

### HANDGUARDS

- BRIGHT WHITE 2876883 \$30<sup>99</sup>
- BLACK 2876846 \$30<sup>99</sup>
- INDY RED 2876845 \$30<sup>99</sup>

• Handguard Mount (2879380) is required when installing Polaris Handguards

• Does not fit with windshields or handlebar-mounted mirrors

» 2879380 • MOUNT • \$30<sup>99</sup> TOP SELLER  
X2 570 '15-21, TOURING 570 '14-21, 6X6 570 '17-21



### THROTTLE/THUMB WARMER TOP SELLER

» 2877364 • \$46<sup>99</sup>  
X2 570 '15-21, TOURING 570 '14-21, 6X6 570 '17-21



### HANDLEBAR MOUNTED MIRRORS TOP SELLER

- For added safety on or off the trail
- Sold as a pair
- Does not fit with windshield fairing or handguards

» 2877222 • \$36<sup>99</sup>  
X2 570 '15-21, TOURING 570 '14-21, 6X6 570 '17-21

## PROTECTION, RACKS & WINDSHIELDS



### FRONT BRUSHGUARD TOP SELLER

» 2879714 • \$179<sup>99</sup>  
X2 570 '15-21, TOURING 570 '14-21, 6X6 570 '17-21



### REAR BRUSHGUARD TOP SELLER

» 2879715 • \$179<sup>99</sup>  
TOURING 570 '14-21

### ULTIMATE SERIES – RACK EXTENDER 4"



### FRONT TOP SELLER

» 2879716 • \$104<sup>99</sup>  
X2 570 '15-21, TOURING 570 '14-21, 6X6 570 '17-21

### LOCK & RIDE SPORTSMAN WINDSHIELDS TOP SELLER

- Windshield installs/removes in seconds without tools
- Lock & Ride mounts allow adjustment of height and angle
- Poly windshields are flexible, impact-resistant, and provide long-term value over the life of your machine
- Does not work with handguards

SIZE	COLOR	PART #	PRICE
TALL 19.25"	CLEAR	2880539-409	\$159 <sup>99</sup>
MID 15.5"	SMOKE	2880540-412	\$144 <sup>99</sup>

X2 570 '18-21, TOURING 570 '18-21



Tall 19.25" Clear



Mid 15.5" Smoke

## WINCHES

### POLARIS HD 3,500 LB. WINCH TOP SELLER

» 2880434 • \$469<sup>99</sup>  
X2 570 '15-21, TOURING 570 '14-21, 6X6 570 '17-21



### POLARIS HD 2,500 LB. WINCH

» 2880432 • \$399<sup>99</sup>  
X2 570 '15-21, TOURING 570 '14-21, 6X6 570 '17-21



NEED A PLOW? SEE P. 46

## STORAGE

### SEMI-RIGID TOURING CARGO BAG

- Large-capacity, heavy-duty vinyl bag
- Three zippered openings, removable dividers
- Attaches to rack with Velcro® straps

» 2877220 • \$159<sup>99</sup>  
TOURING 570 '14-21



### FENDER BAG

- Ideal for holding items you want to keep close at hand such as glasses, gloves, or water bottles
- Easy to access contents while seated

» 2876604 • \$54<sup>99</sup>  
X2 570 '15-21, TOURING 570 '14-21, 6X6 570 '17-21





# 2014-2020 SPORTSMAN 450 • 570

## WINCHES

### POLARIS HD 3,500 LB. WINCH TOP SELLER

» 2880434 • \$469<sup>99</sup>  
570 '14-20, 450 H.O. '16-20



### POLARIS HD 2,500 LB. WINCH TOP SELLER

» 2880432 • \$399<sup>99</sup>  
570 '14-20, 450 H.O. '16-20



NEED A PLOW? SEE P. 46

## PROTECTION



### FRONT BRUSHGUARD TOP SELLER

» 2879714 • \$179<sup>99</sup>  
570 '14-20, 450 H.O. '16-20



### REAR BRUSHGUARD TOP SELLER

» 2879715 • \$179<sup>99</sup>  
570 '14-20, 450 H.O. '16-20

## RACKS

### ULTIMATE SERIES – RACK EXTENDER 4"



### FRONT TOP SELLER

» 2879716 • \$104<sup>99</sup>  
570 '14-20, 450 H.O. '16-20



### REAR TOP SELLER

» 2879717 • \$104<sup>99</sup>  
570 '14-20, 450 H.O. '16-20

## STORAGE



### LOCK & RIDE REAR CARGO BOX TOP SELLER

- Increase your storage with an extra 25 gallons of capacity
- Store two full-size helmets
- Works with Rack Extenders
- Will not fit when Utility Rack is installed

» 2882882 • \$309<sup>99</sup>  
570 '14-20, 450 H.O. '12-20



## COMFORT



### HAND WARMERS TOP SELLER

» 2877363 • \$59<sup>99</sup>  
570 '14-20, 450 H.O. '12-20



### THROTTLE/THUMB WARMER TOP SELLER

» 2877364 • \$46<sup>99</sup>  
570 '14-20, 450 H.O. '12-20



### HANDGUARDS

<input type="checkbox"/> BRIGHT WHITE	2876883	\$30 <sup>99</sup>
<input checked="" type="checkbox"/> BLACK	2876846	\$30 <sup>99</sup>
<input checked="" type="checkbox"/> INDY RED	2876845	\$30 <sup>99</sup>

- Handguard Mount (2879380) is required when installing Polaris Handguards
- Does not fit with windshields or handlebar-mounted mirrors

» 2879380 • MOUNT • \$30<sup>99</sup> TOP SELLER



### HANDLEBAR MOUNTED MIRRORS TOP SELLER

- For added safety on or off the trail
- Sold as a pair
- Does not fit with windshield fairing or handguards

» 2877222 • \$36<sup>99</sup>  
570 '14-20, 450 H.O. '12-20

## WINDSHIELDS



Tall 19.25" Clear



Mid 15.5" Smoke

### LOCK & RIDE SPORTSMAN WINDSHIELDS TOP SELLER

- Windshield installs/removes in seconds without tools
- Lock & Ride mounts allow adjustment of height and angle
- Poly windshields are flexible, impact-resistant, and provide long-term value over the life of your machine
- Does not fit with handguards

SIZE	COLOR	PART #	PRICE
TALL 19.25"	CLEAR	2880539-409	\$159 <sup>99</sup>
MID 15.5"	SMOKE	2880540-412	\$144 <sup>99</sup>

570 '18-20, 450 H.O. '18-20



COMFORT ESSENTIALS



Winches	P. 28	Storage	P. 30
Protection	P. 29	Lighting	P. 48
Racks/Rack Extenders	P. 28	Wheels & Tires	P. 38
Windshields	P. 32		

HUNTER



Winches	P. 28	Hunting Accessories	P. 50
Protection	P. 29	Lighting	P. 48
Racks/Rack Extenders	P. 28	Wheels & Tires	P. 38
Windshields	P. 32		

WORK HARD AND GET IT DONE with Polaris Engineered Accessories. Find everything you need to outfit your trusted partner for the task at hand.

WORKER



Winches	P. 28	Storage	P. 30
Protection	P. 29	Lighting	P. 48
Racks/Rack Extenders	P. 28	Wheels & Tires	P. 38
Windshields	P. 32		

WINTER



Winches	P. 28	Plow System	P. 46
Protection	P. 29	Lighting	P. 48
Rack Extenders	P. 29	Wheels & Tires	P. 38
Windshields	P. 32		



# SPORTSMAN 850 XP 1000 XP 1000 S



## WINCHES

### POLARIS PRO HD 3,500 LB. WINCH

- » 2883580 • \$549<sup>99</sup>  
XP 1000 S '20-21
- » 2882241 • \$549<sup>99</sup>  
XP 1000 '15-21, TOURING XP 1000 '15-21,  
TOURING 850 '12-21, 850 '12-21



LEARN MORE ON P. 12

### POLARIS HD 3,500 LB. WINCH TOP SELLER

- » 2880435 • \$469<sup>99</sup>  
XP 1000 '15-21, TOURING XP 1000 '15-21,  
TOURING 850 '12-21, 850 '12-21



### POLARIS HD 2,500 LB. WINCH

- » 2880433 • \$399<sup>99</sup>  
XP 1000 '15-21, TOURING XP 1000 '15-21,  
TOURING 850 '12-21, 850 '12-21



NEED A PLOW? SEE P. 46

## RACKS

### ULTIMATE SERIES – RACK EXTENDER 4"

#### FRONT

- » 2882022 • \$104<sup>99</sup>  
XP 1000 S '20-21, XP 1000 '17-21,  
850 '17-21



#### REAR

- » 2882023 • \$104<sup>99</sup>  
XP 1000 S '20-21, XP 1000 '17-21,  
850 '17-21  
Fits with Rear Cargo Box (2882882)



### ULTIMATE SERIES – RACK EXTENDER 7"

#### FRONT

- » 2882024 • \$159<sup>99</sup>  
XP 1000 S '20-21, XP 1000 '17-21, 850 '17-21

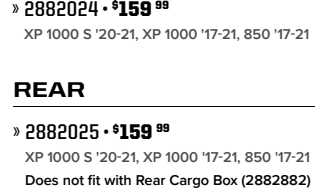

#### REAR

- » 2882025 • \$159<sup>99</sup>  
XP 1000 S '20-21, XP 1000 '17-21, 850 '17-21  
Does not fit with Rear Cargo Box (2882882)



#### FRONT RACK EXTENDER



- » 2879890 • \$104<sup>99</sup>  
TOURING XP 1000 '15-21, TOURING 850 '21  
Does not fit with Front Cargo Box installed

### ULTIMATE SERIES – STEEL RACK

#### FRONT

- » 2883257 • \$159<sup>99</sup>  
XP 1000 S '20-21, XP 1000 '17-21,  
850 '17-21



#### REAR

- » 2883258 • \$209<sup>99</sup>  
XP 1000 S '20-21, XP 1000 '17-21,  
850 '17-21



#### ULTIMATE SERIES – MOVEABLE TIE-DOWN POINTS

- » 2882270 • \$54<sup>99</sup>  
(FRONT & REAR - SOLD IN PAIRS)  
XP 1000 '17-21, 850 '17-21



## PROTECTION



### SPORTSMAN ULTIMATE SERIES – BRUSHGUARD

- Quick installation to the integrated mounting tubes on the vehicle using wedge-style expansion anchor mounts
- Attach the Body Armor to the Front Brushguard to provide the ultimate protection for the front fenders

- » 2882020 • FRONT • \$259<sup>99</sup> TOP SELLER  
XP 1000 S '20-21, XP 1000 '17-21, 850 '17-21
- » 2882583 • REAR • \$209<sup>99</sup>  
XP 1000 '17-21, 850 '17-21



### SPORTSMAN ULTIMATE SERIES – BODY ARMOR

- Securely mounts to Ultimate Series Sportsman XP Front Brushguard (2882020)
- Comes as pair
- » 2882090 • \$309<sup>99</sup>  
XP 1000 '17-21, 850 '17-21



### SPORTSMAN TOURING XP BRUSHGUARD

- Adds heavy-duty protection and a custom look
- » 2878709 • FRONT • \$229<sup>99</sup>  
TOURING XP 1000 '15-21, TOURING 850 '10-21

- » 2878324 • REAR • \$159<sup>99</sup>  
TOURING XP 1000 '15-21,  
TOURING 850 '10-21



# SPORTSMAN 850 XP 1000 XP 1000 S



## STORAGE



### **NEW** REAR CARGO BOX LOCK & RIDE

- Increase your storage with an extra 21.25 gallons of dry, dust-proof storage
- Mounts easily with Lock & Ride to the rear rack and is compatible with rack extenders and gun mount
- Includes 2 padlock locations
- Will not fit when Ultimate Series Steel Rack is installed

» 2884853 • **\$319**<sup>99</sup>  
XP 1000 S '20-21, XP 1000 '17-21, 850 '17-21



### ULTIMATE SERIES – READY PACK

- Keep your trail essentials at the ready with this easy-to-access, weather-resistant storage compartment

» 2882271 • **\$64**<sup>99</sup>  
XP 1000 '17-21, 850 '17-21



### **NEW** OPEN CARGO BOX LOCK & RIDE

- Increase your storage with an extra 22 gallons of convenient storage space
- Mounts easily with Lock & Ride to the rear rack and is compatible with rack extenders and gun mount
- Holds 2, 5-gallon buckets with integrated grab handle to make it easy to carry and transport cargo
- 12 convenient tie-down locations to secure cargo
- Includes 2 padlock locations
- Will not fit when Ultimate Series Steel Rack is installed

» 2884854 • **\$209**<sup>99</sup>  
XP 1000 S '20-21, XP 1000 '17-21, 850 '17-21



### FRONT CARGO BOX LOCK & RIDE

» 2877951 • **\$179**<sup>99</sup>  
TOURING XP 1000 '15-21, TOURING 850 '10-21  
The Front Rack Extender cannot be installed at the same time as the storage box



### **NEW** REAR COOLER BOX LOCK & RIDE

- Increase your storage with an extra 46 quarts of weather resistant cooler storage space
- Mounts easily with Lock & Ride to the rear rack and is compatible with rack extenders and gun mount
- Integrated bottle opener and 2 padlock locations
- Will not fit when Ultimate Series Steel Rack is installed

» 2884857 • **\$399**<sup>99</sup>  
XP 1000 S '20-21, XP 1000 '17-21, 850 '17-21



### REAR STORAGE BOX LOCK & RIDE

» 2878000 • **\$199**<sup>99</sup>  
TOURING XP 1000 '15-21, TOURING 850 '10-21  
Slight interference with Sportsman Touring 550/850 '11-14 passenger handles

## AUDIO



### **NEW** FALL AVAILABILITY REAR AUDIO STORAGE BOX LOCK & RIDE

- Dual 6" Speakers by Rockford Fosgate\* that connect via Bluetooth\*
- Mounts easily with Lock & Ride to the rear rack and is compatible with rack extenders and gun mount
- Rest easy knowing that your speakers are protected with a sealed lid container

» 2884856 • **\$599**<sup>99</sup>  
XP 1000 S '20-21, XP 1000 '17-21, 850 '17-21



### **NEW** AUDIO STORAGE BOX REMOTE

- Easily control the volume or switch to the next song on your Rear Audio Storage Box that conveniently mounts to your ATV's handlebars

» 2884987 • **\$89**<sup>99</sup>  
XP 1000 S '20-21, XP 1000 '17-21, 850 '17-21

## COMFORT



### HANDLEBAR MOUNTED MIRRORS TOP SELLER

- For added safety on or off the trail
- Sold as a pair
- Does not fit with windshield fairing or handguards

» 2877222 • **\$36**<sup>99</sup>  
XP 1000 S '20-21, XP 1000 '15-21, TOURING XP 1000 '15-21, TOURING 850 '10-21, 850 '09-21



### **NEW** HAND & THUMB WARMER KIT

- Provides heat to grips and throttle and is easily installed by plugging into pod
- Includes two heated grips and one throttle warmer

» 2885002 • **\$99**<sup>99</sup>  
XP 1000 S '21, XP 1000 '21, 850 '21



### HAND WARMERS TOP SELLER

» 2877363 • **\$59**<sup>99</sup>  
XP 1000 S '20, XP 1000 '15-20, TOURING XP 1000 '15-21, TOURING 850 '15-21

### HANDGUARDS

■ BRIGHT WHITE	2876883	<b>\$30</b> <sup>99</sup>
■ BLACK	2876846	<b>\$30</b> <sup>99</sup>
■ INDY RED	2876845	<b>\$30</b> <sup>99</sup>

- Handguard Mount (2879380) is required when installing Polaris Handguards
- Does not fit with windshields or handlebar-mounted mirrors

» 2879380 • MOUNT • **\$30**<sup>99</sup> TOP SELLER

XP 1000 S '20-21, XP 1000 '15-21, TOURING XP 1000 '15-21, TOURING 850 '10-21, 850 '09-21



### THROTTLE/THUMB WARMERS TOP SELLER

» 2877364 • **\$46**<sup>99</sup>  
XP 1000 S '20, XP 1000 '15-20, TOURING XP 1000 '15-21, TOURING 850 '15-21



# SPORTSMAN 850 XP 1000 XP 1000 S



## WINDSHIELDS

### NEW LOCK & RIDE SPORTSMAN WINDSHIELDS

- Provides enhanced protection from the elements and off-road hazards
- Easily installs and removes without tools utilizing Lock & Ride Technology
- Improved mounting system for easier and quicker attachment and detachment

SIZE	COLOR	PART #	PRICE
TALL 18"	CLEAR	2884945	\$179 <sup>99</sup>
MID 14"	CLEAR	2884845	\$169 <sup>99</sup>
SHORTS 9"	CLEAR	2884946	\$159 <sup>99</sup>

XP 1000 S '21, XP 1000 '21, 850 '21



### LOCK & RIDE WINDSHIELDS TOP SELLER

- Windshield installs in seconds without tools with its Lock & Ride technology. It can also be removed in seconds without tools
- Lock & Ride mounts allow a rider to adjust the height and angle of the windshield
- Poly windshields are flexible, impact-resistant, and provide long-term value over the life of your machine
- Does not work with handguards

SIZE	COLOR	PART #	PRICE
TALL 19.25"	CLEAR	2880539-409	\$159 <sup>99</sup>
MID 15.5"	SMOKE	2880540-412	\$144 <sup>99</sup>

TOURING XP 1000 '15-21, TOURING 850 '15-21



### LOCK & RIDE ULTIMATE SERIES WINDSHIELD FAIRING

- Customizable system based on your style and protection needs
- Install just the fairing or add any of the windshields listed to the right
- Does not work with handguards or handlebar mounted mirror

» 2882512 • \$159<sup>99</sup>  
XP 1000 S '20, XP 1000 '17-20, 850 '17-20



### ULTIMATE SERIES WINDSHIELDS

- Fairing required to add your preferred windshield

SIZE	PART #	PRICE
TALL 20"	2882152	\$104 <sup>99</sup>
MID 16"	2882151	\$94 <sup>99</sup>

XP 1000 S '20, XP 1000 '17-20, 850 '17-20



EASY TO CHANGE WINDSHIELDS WITH 6-DART INSTALL

Our fairing system allows for changing out the windshield quickly and easily. Simply remove the six dart-type fasteners and swap out the windshield.

## DO MORE

### LIGHTING SEE P. 48



### PLOWS SEE P. 46



### HUNT SEE P. 50



### WHEELS & TIRES SEE P. 38





# SCRAMBLER 850 XP 1000 S



## WINCH



### POLARIS PRO HD 3,500 LB. WINCH

- » 2883580 • \$549<sup>99</sup>  
SCRAMBLER XP 1000 S '20-21
- » 2882241 • \$549<sup>99</sup>  
SCRAMBLER 850 '14-21, SCRAMBLER XP 1000 '14-18



### POLARIS TOP SELLER HD 3,500 LB. WINCH

- » 2880435 • \$469<sup>99</sup>  
SCRAMBLER 850 '14-21, SCRAMBLER XP 1000 '14-18



### POLARIS HD 2,500 LB. WINCH

- » 2880433 • \$399<sup>99</sup>  
SCRAMBLER 850 '14-21, SCRAMBLER XP 1000 '14-18

## RACKS/STORAGE



### LARGE REAR RACK

- » 2879139 • \$169<sup>99</sup>  
SCRAMBLER XP 1000 S '20-21, SCRAMBLER XP 1000 '14-18,  
SCRAMBLER 850 '14-21  
Not compatible with Ogio® Bag (2879925)



### OGIO® BAG

- » 2879925 • \$179<sup>99</sup>  
SCRAMBLER XP 1000 S '20-21, SCRAMBLER XP 1000 '14-18,  
SCRAMBLER 850 '14-21

## PROTECTION



### ULTIMATE SPORT SERIES FRONT BRUSHGUARD

- » 2883595 • \$249<sup>99</sup>  
SCRAMBLER XP 1000 S '20-21



### FRONT BRUSHGUARD

- » 2879136 • \$209<sup>99</sup>  
SCRAMBLER 850 '14-21, SCRAMBLER XP 1000 '14-18  
Replaces existing lower bumper. Will not work together



### REAR BASH GUARD

- » 2879138 • \$144<sup>99</sup>  
SCRAMBLER 850 '14-21, SCRAMBLER XP 1000 '14-18

## MISC SPORTSMAN ACCESSORIES



### BOOM SPRAYER

- » 2882266 • \$419<sup>99</sup>  
ALL SPORTSMAN MODELS EXCEPT TOURING

### ATV LICENSE PLATE

- Includes numbers and letters
- » 2873270 • \$13<sup>99</sup>  
ALL SPORTSMAN MODELS



### QUICKTAP BATTERY POSTS

- Easy-to-access terminal posts give you quick access to the battery power
- Ideal for charging your battery, powering a temporary accessory, or when you need to offer an unexpected jump-start
- Connection posts feature covers to protect terminals when not in use
- » 2882110 • \$54<sup>99</sup>  
X2 570 '15-21, TOURING 570 '14-21, 6X6 570 '17-21,  
570 '14-20, 450 H.O. '19-20



### RIDE & REPAIR ESSENTIALS KIT

- 12-volt DC portable air compressor
- Tire repair kit with 6 plugs
- Basic first-aid kit with bandages, scissors, safety pins, and more
- 12-volt jumper cables
- Duct tape - 300mm x 1 roll
- Zip ties - 150mm length
- Electrical tape
- Ratchet strap - 50mm
- Microfiber cloth
- Carry bag
- » 2881207 • \$104<sup>99</sup>



# YOUTH ATVs

The perfect first All-Terrain Vehicle for kids starting at 6 years and older.



## OUTLAW 70 EFI



### NEW FRONT BRUSHGUARD

- Provides enhanced protection from brush and other debris on the trail

» 2884567 • \$119<sup>99</sup>

OUTLAW 70 '21



### NEW REAR BRUSHGUARD

- Protect the rear of your youth ATV from hazards on the trails

» 2884778 • \$39<sup>99</sup>

OUTLAW 70 '21



### NEW WINDSHIELD - POLY

- Added wind and hand protection with a durable poly design

» 2885005 • \$99<sup>99</sup>

OUTLAW 70 '21



### NEW DECAL KIT - INDY RED

- Replaces the stock Outlaw 70 decals to provide a unique and custom look for your youth ATV

» 2885107 • \$89<sup>99</sup>

OUTLAW 70 '21



### NEW REAR STORAGE BAG

- Convenient storage that easily connects to the rear rack of your youth ATV

» 2884555 • \$63<sup>99</sup>

OUTLAW 70 '21

## YOUTH WHEELS & TIRES

### NEW YOUTH CRAWLER TIRE

- Upgraded youth tire for added durability
- Increased ground clearance and performance

ACE 150 '17-21



	TREAD DEPTH	TIRE WEIGHT	PLY RATING	SIDEWALL BELTS	LOAD RATING	
12" FRONT	22" x 8" R12 5416945 • \$99 <sup>99</sup>	13 mm	18 lbs	6	3	910 lbs
12" REAR	22" x 10" R12 5416944 • \$109 <sup>99</sup>					

### NEW YOUTH BUCKLE - BLACK

» FRONT • 12" x 7" • 1524114 • \$89<sup>99</sup>

ACE 150 '17-21

» REAR • 12" x 8" • 1524115 • \$99<sup>99</sup>

ACE 150 '17-21



### NEW PRO ARMOR WHEEL & TIRE SET: YOUTH CRAWLER & BUCKLE

» 2885154 • \$739<sup>99</sup>

ACE 150 '17-21



## ACE 150



### POLY ROOF

» 2882263 • \$134<sup>99</sup>

ACE 150 '17-21

### HALF POLY WINDSHIELD

» 2882264 • \$104<sup>99</sup>

ACE 150 '17-21

### FRONT & REAR BRUSHGUARD SET

» 2882472 • \$104<sup>99</sup>

ACE 150 '17-21



# KNOW YOUR TERRAIN



- Tread patterns optimized for extreme traction
- Ideal for both hard pack and loose trail



- Flexible "grippy" tread
- Aggressive side bite



- Provides traction and durability
- Built to perform in hard sand, jagged rocks or any other extreme terrain



- Extra deep treads
- Self-cleaning lugs



- Paddles provide traction and durability in soft sand
- Built to float on top of sand



- Industry leading anti-puncture side walls
- Purpose-built, long lasting tread patterns



- Handles extreme cold
- Holds shape and provides traction

# SUPERIOR PERFORMANCE & DURABILITY

# WAYS TO SHOP TIRES



## PRO ARMOR

### LIFELONG PERFORMANCE

- Every tire is designed and constructed with longevity in mind
- 3,000+ mile rated

### PREMIUM PROTECTION

- Pro Armor makes tires with extra protection exactly where it's needed most—the sidewall
- Triple-belted sidewalls keep your tires more resistant so you can keep going

### TOUGHEST TIRES

- Higher ply ratings mean added protection
- Pro Armor builds 8 or 10-ply rated tires for higher puncture-resistance



## KNOW YOUR TIRES

DIMENSIONS			TREAD DEPTH	TIRE WEIGHT	PLY RATING	SIDEWALL BELTS	LOAD RATING
TIRE HEIGHT	TIRE WIDTH	WHEEL DIAMETER					
<b>32" x 9"</b>	<b>R15</b>	<b>FRONT/REAR</b>	<b>30 mm</b>	<b>41 lbs</b>	<b>10</b>	<b>3</b>	<b>1,320 lbs</b>
Part Number • Price							

**USAGE**  
Where can you use the tire

**TREAD DEPTH**  
Deeper treads have more grip in all conditions

**TIRE WEIGHT**  
A lighter tire makes for improved vehicle performance

**PLY RATING**  
Indicates tire puncture-resistance

**SIDEWALL BELTS**  
Increase your resistance to sidewall punctures

**LOAD RATING**  
How much weight can the tire handle

## TIRES BY SIZE

26"	27"
ATTACK	MUD XC
DUAL-THREAT	PRESERVE
	HARVESTER
	WHITEOUT

## TIRES BY TERRAIN

TRAIL	ROCK	DESERT	MUD	UTILITY	SNOW
DUAL-THREAT	DUAL-THREAT	DUAL-THREAT	MUD XC	ATTACK	ATTACK
ATTACK	ATTACK	ATTACK		HARVESTER	HARVESTER
HARVESTER				PRESERVE	PRESERVE
PRESERVE				XD-K	XD-K
XD-K					WHITEOUT
MUD XC					

## TIRES



### PRO ARMOR DUAL-THREAT

- Dual-compound technology and radial construction offer performance in all terrains
- Softer durometer rubber on outer edge for overall superior grip and feel
- Harder durometer rubber in the middle for increase traction during acceleration and longer tread life

		TREAD DEPTH	TIRE WEIGHT	PLY RATING	SIDEWALL BELTS	LOAD RATING
14"	<b>26" x 9" R14</b> 5416340 • \$169 <sup>99</sup>	16 mm	27 lbs	10	3	910 lbs
14"	<b>26" x 11" R14</b> 5416341 • \$179 <sup>99</sup>		30 lbs			1,100 lbs



### PRO ARMOR ATTACK

- The best all-purpose tire for all-season traction in any terrain
- Unique full-face tread design
- Harder durometer lugs promote extended wear, increasing tire life

		TREAD DEPTH	TIRE WEIGHT	PLY RATING	SIDEWALL BELTS	LOAD RATING
14"	<b>26" x 9" R14</b> 5415613 • \$144 <sup>99</sup>	23 mm	28 lbs	8	3	910 lbs
14"	<b>26" x 11" R14</b> 5415614 • \$159 <sup>99</sup>		32 lbs			1,320 lbs



COMMON

WINCHES

450-570

850-XP1000-XP1000S

SCRAMBLER 850-XP1000S

MISC & YOUTH

WHEELS & TIRES

TRACKS & PLOW

LIGHTING

HUNT & COOLERS



# TIRES



## PRO ARMOR HARVESTER

- All-around workhorse with tread life of 5,000 miles
- Tread pattern designed to withstand anything from the farmyard to the pastures to the trail
- With 10-ply, it can carry the load day-in and day-out

		TREAD DEPTH	TIRE WEIGHT	PLY RATING	SIDEWALL BELTS	LOAD RATING	
14"	<b>26" x 8" R12</b> 5416396 • \$179 <sup>99</sup>	FRONT	24 lbs			855 lbs	
12"	<b>26" x 10" R12</b> 5415966 • \$189 <sup>99</sup>	REAR	16 mm	32 lbs	10	3	1,320 lbs
12"	<b>27" x 10" R14</b> 5415965 • \$189 <sup>99</sup>	FRONT/REAR		32 lbs			1,320 lbs



## PRO ARMOR WHITEOUT

- Extra wide tires for flotation in snow
- Tread pattern designed for superior snow traction with limited digging

		TREAD DEPTH	TIRE WEIGHT	PLY RATING	SIDEWALL BELTS	LOAD RATING	
14"	<b>27" x 14" R14</b> 5416032 • \$279 <sup>99</sup>	FRONT/REAR	16 mm	24 lbs	8	3	935 lbs



## PRO ARMOR PRESERVE

- Turf-friendly for areas where low impact from tire tread is needed
- Exceptionally quiet-running tire
- Low impact tire

		TREAD DEPTH	TIRE WEIGHT	PLY RATING	SIDEWALL BELTS	LOAD RATING	
14"	<b>27" x 10" R14</b> 5416348 • \$189 <sup>99</sup>	FRONT	24 lbs			855 lbs	
12"	<b>26" x 10" R12</b> 5416402 • \$189 <sup>99</sup>	REAR	16 mm	28 lbs	10	3	1,320 lbs
12"	<b>26" x 8" R12</b> 5416403 • \$179 <sup>99</sup>	FRONT/REAR		29 lbs			1,320 lbs

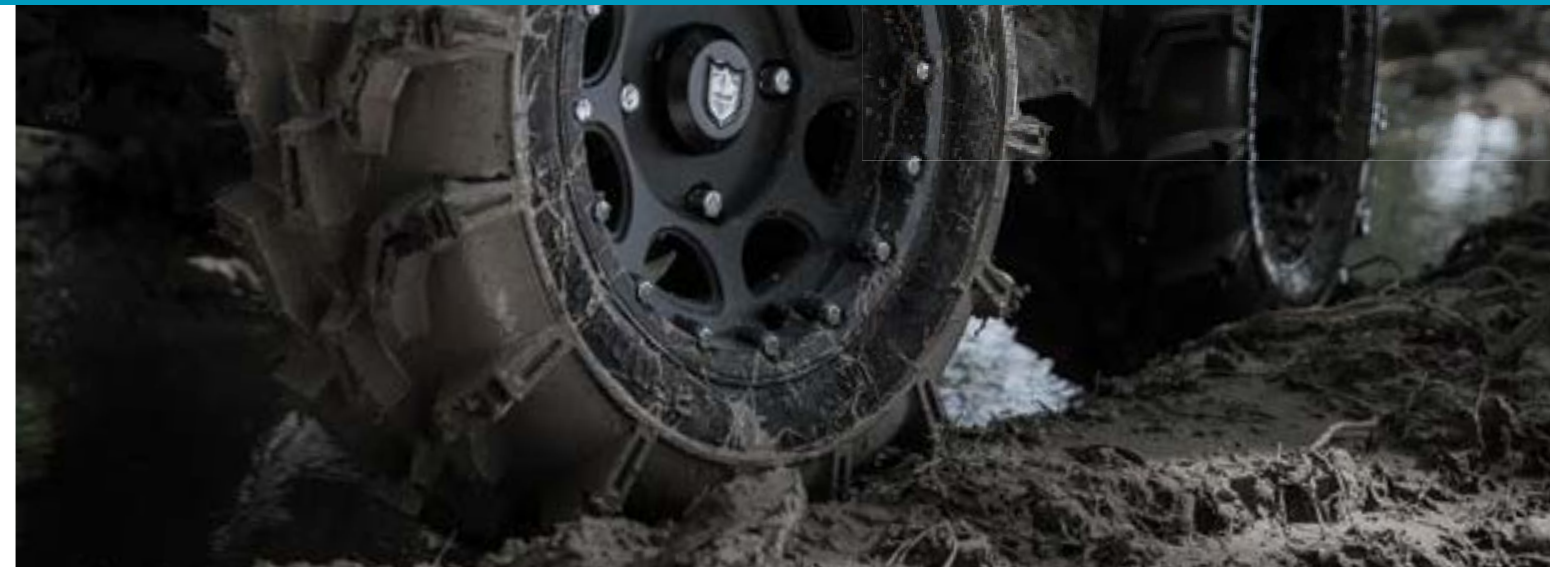

## PRO ARMOR XD-K

- 26" Aramid fiber-belted tire can tackle any terrain
- Unique full-face tread design
- Harder durometer lugs promotes for extended wear increasing tire life

		TREAD DEPTH	TIRE WEIGHT	PLY RATING	SIDEWALL BELTS	LOAD RATING	
12"	<b>26" x 9" R12</b> 5415756 • \$216 <sup>99</sup>	FRONT	31.7 mm	28 lbs	8	3/1 Aramid	935 lbs
12"	<b>26" x 11" R12</b> 5415757 • \$226 <sup>99</sup>	REAR		32 lbs			1,330 lbs



## PRO ARMOR MUD XC

- Designed for the perfect mud-trail crossover for a smooth ride on the trail and aggressive traction in the mud
- Dual-compound technology with harder durometer lugs promote extended wear, increasing tire life
- 10-ply construction, means added protection in the toughest terrain

		TREAD DEPTH	TIRE WEIGHT	PLY RATING	SIDEWALL BELTS	LOAD RATING	
14"	<b>27" x 9" R14</b> 5416947 • \$189 <sup>99</sup>	FRONT	30 mm	30 lbs	10	3	1,170 lbs
14"	<b>27" x 11" R14</b> 5416948 • \$199 <sup>99</sup>	REAR		32 lbs			1,320 lbs



COMMON

WINCHES

450-570

850-XP1000-XP1000S

SCRAMBLER 850-XP1000S

MISC & YOUTH

WHEELS & TIRES

TRACKS & PLOW

LIGHTING

HUNT & COOLERS



# WHEELS



## A 4201 (AMPLIFY) ○

FRONT WEIGHT: 13 lbs | LOAD RATING: 900 lbs | OFFSET: +4  
REAR WEIGHT: 14 lbs | LOAD RATING: 1300 lbs | OFFSET: -9

ACCENT: FRONT 14" x 7" 1522956-266 \$144<sup>99</sup>  
REAR 14" x 8" 1522957-266 \$159<sup>99</sup>  
MATTE BLACK: FRONT 14" x 7" 1522956-458 \$124<sup>99</sup>  
REAR 14" x 8" 1522957-458 \$134<sup>99</sup>

## D 4203 BEADLOCK (REBLR) ○

FRONT WEIGHT: 13 lbs | LOAD RATING: 900 lbs | OFFSET: +4  
REAR WEIGHT: 14.5 lbs | LOAD RATING: 1300 lbs | OFFSET: -9

MATTE BLACK: FRONT 14" x 7" 1522238-458 \$219<sup>99</sup>  
REAR 14" x 8" 1522239-458 \$219<sup>99</sup>

## G 4206 (SPLIT) ○

FRONT WEIGHT: 9.5 lbs | LOAD RATING: 900 lbs | OFFSET: +4  
REAR WEIGHT: 10.75 lbs | LOAD RATING: 1300 lbs | OFFSET: -9

MATTE BLACK: FRONT 14" x 6" 1522542-458 \$124<sup>99</sup>  
REAR 14" x 8" 1522543-458 \$134<sup>99</sup>

## B 4202 (BUCKLE) ○

FRONT WEIGHT: 12.75 lbs | LOAD RATING: 900 lbs | OFFSET: +4  
REAR WEIGHT: 13.5 lbs | LOAD RATING: 1300 lbs | OFFSET: -9

ACCENT: FRONT 14" x 7" 1522544-266 \$144<sup>99</sup>  
REAR 14" x 8" 1522545-266 \$159<sup>99</sup>  
MATTE BLACK: FRONT 14" x 7" 1522544-458 \$124<sup>99</sup>  
REAR 14" x 8" 1522545-458 \$134<sup>99</sup>

## E 4204 (SHACKLE) ○

FRONT WEIGHT: 13 lbs | LOAD RATING: 900 lbs | OFFSET: +4  
REAR WEIGHT: 14 lbs | LOAD RATING: 1300 lbs | OFFSET: -9

ACCENT: FRONT 14" x 7" 1522546-266 \$144<sup>99</sup>  
REAR 14" x 8" 1522547-266 \$144<sup>99</sup>  
MATTE BLACK: FRONT 14" x 7" 1522546-458 \$124<sup>99</sup>  
REAR 14" x 8" 1522547-458 \$124<sup>99</sup>

## H 4101 (WHITEOUT) ○

WEIGHT: 14.5 lbs | LOAD RATING: 800 lbs | OFFSET: -35

MATTE BLACK: FRONT/REAR 14" x 10" 1522958 \$179<sup>99</sup>

## C 4301 BEADLOCK (COMBAT)

WEIGHT: 16 lbs | LOAD RATING: 1600 lbs | OFFSET: +38

ACCENT: FRONT/REAR 14" x 7" 1523284 \$209<sup>99</sup>  
MATTE BLACK: FRONT/REAR 14" x 7" 1523283 \$199<sup>99</sup>

## F 4205 (SIXR) ○

FRONT WEIGHT: 10.5 lbs | LOAD RATING: 900 lbs | OFFSET: +4  
REAR WEIGHT: 12.5 lbs | LOAD RATING: 1300 lbs | OFFSET: -9

MATTE BLACK: FRONT 14" x 7" 1521507-521 \$114<sup>99</sup>  
REAR 14" x 8" 1521508-521 \$124<sup>99</sup>

## I HD DUAL BEADLOCK ○

WEIGHT: 40 lbs | LOAD RATING: 1,600 lbs | OFFSET: +38

MATTE BLACK: FRONT/REAR 14" x 7" 1524022-458 \$269<sup>99</sup>

## KNOW YOUR WHEELS

### STEP 1: SELECT SERIES

4 = 40-SERIES

### STEP 2: CHOOSE LOAD RATING

1 = <800 LBS  
2 = 801 - 1,300 LBS  
3 = 1,301 - 1,600+ LBS

### STEP 3: PICK STYLE

OFFSET / BEADLOCK / COLOR

INCREASE OFFSET FROM STOCK = NARROWER STANCE  
DECREASE OFFSET FROM STOCK = WIDER STANCE

## 2 WAYS TO PURCHASE

INDIVIDUAL WHEELS & TIRES  
-OR-  
COMPLETE SETS AS LISTED

visit [Polaris.com/ProArmorSPORTSMAN](http://Polaris.com/ProArmorSPORTSMAN)  
TO BUILD YOUR CUSTOM SET AND VERIFY FITMENT

Exclusively at Polaris Authorized Dealers or [Polaris.com/ProArmorSPORTSMAN](http://Polaris.com/ProArmorSPORTSMAN)

## 14" FORGED BEADLOCK RINGS

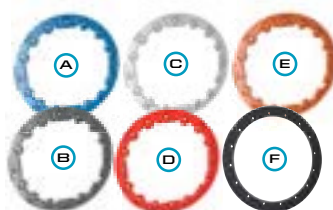

### PRO ARMOR FORGED RINGS Sold individually

Only used on 4203 (REBLR)

	PART #	
A	1522244-619	\$84 <sup>99</sup>
B	1522244-266	\$84 <sup>99</sup>
C	1522244-133	\$84 <sup>99</sup>
D	1522244-293	\$84 <sup>99</sup>
E	1522244-589	\$84 <sup>99</sup>
F	Beadlock Ring - Matte Black - 14"	\$54 <sup>99</sup>
	Only used on 4301 (Combat)	

## KNOW YOUR TERRAIN



• Tread patterns optimized for extreme traction  
• Ideal for both hard pack and loose trail



• Extra deep treads  
• Self-cleaning lugs



• Industry leading anti-puncture side walls  
• Purpose-built, long lasting tread patterns



• Handles extreme cold  
• Holds shape and provides traction

# WHEEL & TIRE SETS

40-SERIES	14"	TRAIL		MUD		UTILITY		SNOW	
		ATTACK 26"	DUAL-THREAT 26"	MUD XC 27"	PRESERVE 27"	HARVESTER 27"	WHITEOUT 27"		
○ 4201 (AMPLIFY) Accent		2882390 \$1,239 <sup>99</sup>	2883138 \$1,289 <sup>99</sup>	2884272 \$1,349 <sup>99</sup>	2883208 \$1,339 <sup>99</sup>	2882388 \$1,339 <sup>99</sup>			
○ 4201 (AMPLIFY) Matte Black		2882391 \$1,139 <sup>99</sup>	2883139 \$1,189 <sup>99</sup>	2884273 \$1,249 <sup>99</sup>	2883209 \$1,239 <sup>99</sup>	2882389 \$1,239 <sup>99</sup>			
○ 4202 (BUCKLE) Accent		2881335 \$1,239 <sup>99</sup>	2883140 \$1,289 <sup>99</sup>	2884267 \$1,349 <sup>99</sup>	2883203 \$1,339 <sup>99</sup>	2882383 \$1,339 <sup>99</sup>			
○ 4202 (BUCKLE) Matte Black		2881336 \$1,139 <sup>99</sup>	2883141 \$1,189 <sup>99</sup>	2884268 \$1,249 <sup>99</sup>	2883204 \$1,239 <sup>99</sup>	2882384 \$1,239 <sup>99</sup>			
4301 (COMBAT) Accent BEADLOCKS PRE-MOUNTED			2883217 \$1,599 <sup>99</sup>						
4301 (COMBAT) Matte Black BEADLOCKS PRE-MOUNTED			2883216 \$1,499 <sup>99</sup>						
○ 4203 (REBLR) Matte Black BEADLOCKS SOLD SEPARATELY		2881381 \$1,289 <sup>99</sup>							
○ 4204 (SHACKLE) Accent		2881347 \$1,239 <sup>99</sup>	2883142 \$1,289 <sup>99</sup>	2884270 \$1,349 <sup>99</sup>	2883205 \$1,339 <sup>99</sup>	2882385 \$1,339 <sup>99</sup>			
○ 4204 (SHACKLE) Matte Black		2881348 \$1,139 <sup>99</sup>	2883143 \$1,189 <sup>99</sup>	2884271 \$1,249 <sup>99</sup>		2882386 \$1,239 <sup>99</sup>			
○ 4205 (SIXR) Luster		2881359 \$1,239 <sup>99</sup>	2883144 \$1,189 <sup>99</sup>						
○ 4205 (SIXR) Matte Black		2881360 \$1,139 <sup>99</sup>	2883145 \$1,189 <sup>99</sup>	2884269 \$1,239 <sup>99</sup>	2883207 \$1,239 <sup>99</sup>	2882387 \$1,239 <sup>99</sup>			
○ 4206 (SPLIT) Matte Black		2881404 \$1,139 <sup>99</sup>							
○ 4101 (WHITEOUT) Matte Black								2882382 \$1,859 <sup>99</sup>	

## LUG NUTS

○ LUG NUTS REQUIRED



### METRIC LUG NUTS FOR ALUMINUM RIMS

» 2877385 - SET OF 4 - \$12<sup>99</sup>  
» 2877384 - SET OF 16 - \$30<sup>99</sup> SPORTSMAN XP

### SAE LUG NUTS FOR ALUMINUM RIMS

» 2876754 - SET OF 4 - \$12<sup>99</sup>  
» 2877409 - SET OF 16 - \$30<sup>99</sup> SPORTSMAN 450/570

## REPLACEMENT CAPS

### CENTER CAP

LUSTER	ALL WHEELS EXCEPT 4204 (WYDE) & 4203 (HEXLR)	1521509-410 • \$10 <sup>99</sup>
MATTE BLACK		1521509-521 • \$10 <sup>99</sup>
HD BEADLOCK MATTE BLACK	ALL WHEELS	5457498-458 • \$20 <sup>99</sup>

### PRO ARMOR CENTER CAP

LUSTER	ALL WHEELS EXCEPT 4204 (WYDE) & 4203 (HEXLR)	5453209-410 • \$10 <sup>99</sup>
MATTE BLACK		5453209-458 • \$10 <sup>99</sup>



### TIRE SEALANT P. 65

» 32 OZ. • 2830484 • \$20<sup>99</sup>  
» 1 GALLON • 2830485 • \$72<sup>99</sup>  
» 5 GALLON • 2830486 • \$298<sup>99</sup>  
» 5 GALLON PUMP • 2830487 • \$133<sup>99</sup>



### COLBY VALVE SHORT ULTIMATE VALVE - 2 PACK

» 2883292 • \$36<sup>99</sup>



### COLBY VALVE EMERGENCY VALVE - 2 PACK

» 2883293 • \$36<sup>99</sup>



# ALL-TERRAIN TRACTION

It's tough to make Sportsman even more versatile than it already is. But with a set of Prospector Pro® Tracks, you'll do just that. Tread through deep snow without concern.

Polaris-specific gearing provides 1:1 ratio to:

- Minimize track slip, providing better climbing ability and improved traction in deep snow
- Improve top speed over prior models by approximately 5%
- Reduce operating RPM for a quieter ride
- Improve driveline durability, which allows vehicle to run at a lower RPM, decreasing engine wear

Polaris exclusive optimized hub geometry that minimizes feedback and eases steering effort

Lightweight design provides for better flotation, eases steering effort, and provides better vehicle control

Flexible lug design provides the highest level of deep snow performance by lifting up in deep snow as opposed to digging down

New front dual stabilizer for improved stability

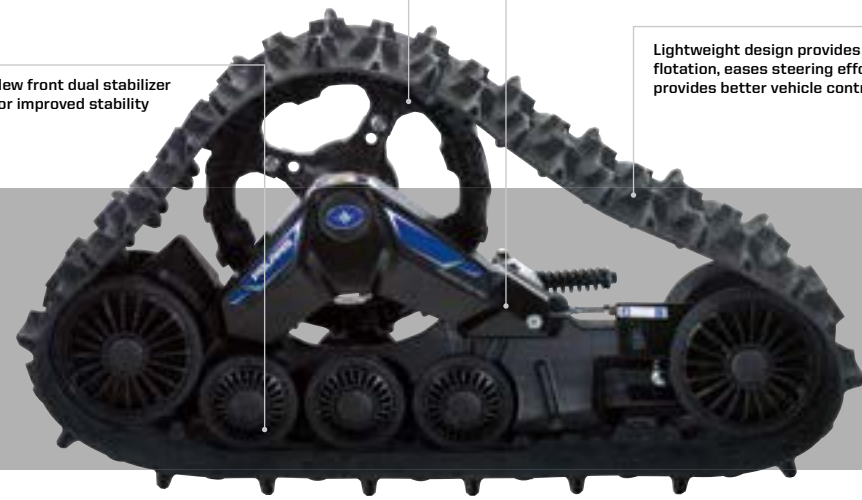

**PROSPECTOR PRO**  
TRACK SYSTEM

MODELS	TYPE	STEP 1 SELECT A MOUNT	STEP 2 SELECT A KIT
SPORTSMAN 570 '15-21 SPORTSMAN 570 SP '15-19 SPORTSMAN TOURING 570 '15-21 SPORTSMAN X2 570 '15-21	EPS	2879497   \$439 <sup>99</sup>	2881025   \$4,199 <sup>99</sup>
SPORTSMAN XP 1000 S '20-21 SCRAMBLER XP 1000 S '20-21	EPS	2883977   \$439 <sup>99</sup>	2881003   \$4,199 <sup>99</sup>
SPORTSMAN XP 1000 '17-21 SPORTSMAN 850 '18-21	EPS	2882109   \$439 <sup>99</sup>	2881003   \$4,199 <sup>99</sup>
SCRAMBLER 1000 '15-18 SPORTSMAN TOURING XP 1000 '17-21 SPORTSMAN TOURING 850 '20-21	EPS	2879457   \$439 <sup>99</sup>	2881003   \$4,199 <sup>99</sup>
SPORTSMAN 570 '14-21 SPORTSMAN TOURING 570 '15-21	NON-EPS	2879497   \$439 <sup>99</sup>	2880020   \$4,199 <sup>99</sup>
SCRAMBLER 850 '13-21 SPORTSMAN 850 '15-21	NON-EPS	2879457   \$439 <sup>99</sup>	2879720   \$4,199 <sup>99</sup>
SPORTSMAN XP 1000 '18-21	NON-EPS	2882109   \$439 <sup>99</sup>	2879720   \$4,199 <sup>99</sup>
570 6X6 '17-21	EPS	2882169   \$5,999 <sup>99</sup>	Includes Track Mount & Track Kit

## WANT TO PLOW?

### GLACIER® PRO PLOW TRACK EXTENSION

- Plow extension for use when using the Prospector Pro® Track System and Glacier® Pro Sportsman plow system









» 2879719 • \$189<sup>99</sup>

FOR USE WITH GLACIER® PRO PLOW SYSTEMS



WANT TO PLOW? SEE P. 46

## SPORTSMAN SNOW TRACTION OPTIONS

TREAD THROUGH SNOW WITH THESE OPTIONS	CONTACT PATCH	TURNING RADIUS
 <p><b>STOCK TIRES</b></p>	<p><b>GOOD</b></p> 	<p><b>139.5"</b></p> 
 <p><b>PRO ARMOR WHITEOUT</b></p>	<p><b>BETTER</b></p>  <p>MORE SURFACE AREA FOR BETTER FLOTATION ON SNOW</p>	<p><b>138.875"</b></p> 
 <p><b>PROSPECTOR PRO® TRACKS</b></p>	<p><b>BEST</b></p>  <p>LESS AGGRESSIVE TREAD DISPLACES SNOW FOR BETTER HANDLING</p>	<p><b>175.375"</b></p> 



# GLACIER<sup>®</sup>

## PLOW SYSTEM

TAKE COMMAND OF CLEARING SNOW AND MAKE QUICK WORK OF EVEN THE HEAVIEST JOBS.



# BUILD YOUR PERFECT PLOW SYSTEM

### ADD HYDRAULICS



### CONTROL FROM THE PALM OF YOUR HAND

Change the angle of the plow blade with the Power Controller.



### HYDRAULIC CONTROL FOR EXTREME SNOW REMOVAL



### GLACIER<sup>®</sup> PRO HD GIVES YOU

» 66", 60" or 52" Blades

» Choice of poly or steel

» Ability to add a hydraulic angle system

## THE POLARIS ENGINEERED ADVANTAGE

### INSTALLATION

30 seconds: Drive up, clip in, lock down, and go – the integrated Polaris Engineered Glacier<sup>®</sup> Plow System simplifies plowing.



### CONVENIENCE

Lift and angle adjustments can be made from the driver's seat.

ANGLE YOUR BLADE RIGHT FROM YOUR SEAT WITH THE GLACIER<sup>®</sup> PRO PLOW HYDRAULIC ANGLE SYSTEM



### ROBUST FRAME

A plow system is only as strong as its frame, and Polaris Engineered plow frames have a wide frame to withstand the rigors of heavy plowing.



### DURABLE BLADES

Available in strong stamped steel or corrosion-resistant poly materials, Polaris Engineered plow blades cover a large surface area for quick snow removal.



66" POLY BLADE

60" & 52" STEEL BLADE

MODELS	MANDATORY STEPS			OPTIONAL	
	STEP 1 SELECT A MOUNT	STEP 2 SELECT A FRAME	STEP 3 SELECT PLOW CONFIGURATION	BLADES	STEP 4 ADD HYDRAULICS
<b>XP 1000</b> '15-21 <b>850</b> '15-21, <b>850 SP</b> '15-19 <b>850/XP 1000 HIGHLIFTER</b> '16-21 <b>TOURING XP 1000</b> '15-21 <b>TOURING 850 SP</b> '15-19 <b>TOURING 850</b> '10-21 <b>SCRAMBLER 850</b> '14-21	2881423   \$179 <sup>99</sup>		<b>Polaris Pro HD 3,500 lb. Winch</b> 2882241   \$549 <sup>99</sup>  <b>Polaris HD 3,500 lb. Winch</b> 2880435   \$469 <sup>99</sup>  <b>Polaris HD 2,500 lb. Winch</b> 2880433   \$399 <sup>99</sup>		
<b>XP 1000 S</b> '20-21 <b>SCRAMBLER XP 1000 S</b> '20-21	2883581   \$179 <sup>99</sup>		<b>Polaris PRO HD 3,500 lb. Winch</b> 2883580   \$549 <sup>99</sup>		
<b>570 SP</b> '15-19 <b>570</b> '15-20 <b>6X6 570</b> '17-21 <b>X2 570</b> '15-21 <b>TOURING 570 SP</b> '15-19 <b>TOURING 570</b> '14-21 <b>450 H.O.</b> '12-20	2881424   \$179 <sup>99</sup>	2879630   \$259 <sup>99</sup>	<b>Polaris HD 3,500 lb. Winch</b> 2880434   \$469 <sup>99</sup>  <b>Polaris HD 2,500 lb. Winch</b> 2880432   \$399 <sup>99</sup>	<b>66" Poly</b> 2880269   \$419 <sup>99</sup>  <b>60" Steel</b> 2879638   \$259 <sup>99</sup>  <b>52" Steel</b> 2879639   \$219 <sup>99</sup>	<b>Hydraulic Plow Blade Angle System</b> 2879635   \$569 <sup>99</sup>  <b>Power Controller</b> 2880836   \$104 <sup>99</sup>  Power Controller Recommended
<b>450 H.O.</b> '21 <b>570</b> '21			<b>Polaris Pro HD 3,500 lb. Winch</b> 2884834   \$549 <sup>99</sup>  <b>Polaris HD 3,500 lb. Winch</b> 2884833   \$469 <sup>99</sup>  <b>Polaris HD 2,500 lb. Winch</b> 2884832   \$399 <sup>99</sup>		

### STEP 5 SELECT ACCESSORIES & REPLACEMENT ITEMS

#### ACCESSORIES & REPLACEMENT ITEMS

<b>66" HD Wear Bar</b> 2879868   \$104 <sup>99</sup> <b>66" Wear Bar</b> 2879867   \$54 <sup>99</sup> <b>60" Wear Bar</b> 2877243   \$41 <sup>99</sup> <b>52" Wear Bar</b> 2877210   \$36 <sup>99</sup>	<b>66" Plow Blade Snow Deflector</b> 2879866   \$84 <sup>99</sup> <b>60" Plow Blade Deflector</b> 2871808   \$64 <sup>99</sup> <b>Skid Shoe</b> 2205071   \$25 <sup>99</sup> <b>Glacier<sup>®</sup> Pro Shear Pin Replacement</b> 2205063   \$14 <sup>99</sup>	<b>Plow Winch Rope</b> For 2,500 lb. & 3,500 lb. winches   2878483   \$30 <sup>99</sup> <b>Glacier<sup>®</sup> Plow Marker</b> Sold in pairs   2872726   \$30 <sup>99</sup> <b>Rear Tire Chains</b> Recommended for rear tires only   2881422   \$104 <sup>99</sup> <b>Plow Blade Track Extension</b> Required for track equipped vehicles   2879719   \$189 <sup>99</sup>
--	---	---

NEED TRACKS? SEE P. 44

COMMON

WINCHES

450-570

850-XP1000-XP1000S

SCRAMBLER 850-XP1000S

MISC & YOUTH

WHEELS & TIRES

TRACKS & PLOW

LIGHTING

HUNT & COOLERS





**POLARIS ENGINEERED ADVANTAGES**

**MOUNTS PERFECTLY**  
Designed for your Polaris Engineered bumper, roof or other mounting point

**MAX PERFORMANCE**  
Validated to work as hard as your machine does

**DOESN'T OVERTAX**  
Trust it to work when you need it to



**ADVANCED TECH**

RIGID® lights are driven by Aluminum PCB Smart Boards™, 6063-T5 aircraft aluminum extruded housings and Tiger Drylac® UV protection polyester powdercoating.

**EXCLUSIVE OPTICS**

RIGID® lights feature impact-resistant polycarbonate lenses for a 100% water/dustproof seal.

**RIGID® LIMITED LIFETIME WARRANTY**

If you own a RIGID® light and it breaks, we will replace or repair it for life.\*

**RUGGED CONSTRUCTION**

Pro Armor lights are designed to be big and beefy with an aggressive style all their own, and housed in IP67 marine-grade rated UV polyester powdercoating.

**MASSIVELY BRIGHT**

Pro Armor builds bright lights designed for any riding experience. All that power is directed through heat dissipating aluminum for streamlined heat management.

**LIGHT BAR TYPES**



**SR-SERIES PRO**

Sleek, powerful, low-profile (under 2" tall). Lights extreme distances with low energy usage.  
**Available in 10"**



**D-SERIES PRO**

Compact to fit almost anywhere with high output and low energy usage.  
**Available in Driving, Flood & Spot**



SEE THE RIGID® LIGHTING BUYERS GUIDE ON THE POLARIS YOUTUBE CHANNEL Search "RIGID"



**DUAL-ROW LED LIGHT BARS**

The most spread and farthest illumination downrange. Easy to mount.  
**Available in Cube, 10" & 20"**



**SINGLE-ROW LED LIGHT BARS**

Powerful, compact, low-profile light bars with a sleek look.  
**Available in 11" & 20"**



**CUBE LED LIGHTS**

Small size allows mounting in strategic locations for added lighting.  
**Available in Flood & Spot**

**LIGHT BAR OPTIONS**

SHOP & VERIFY VEHICLE FITMENT AT [POLARIS.COM/ShopSPORTSMAN](http://POLARIS.COM/ShopSPORTSMAN)

**OPTICS DRIVING**

**FLOOD**

**SPOT**

**COMBO**

**OPTICS**

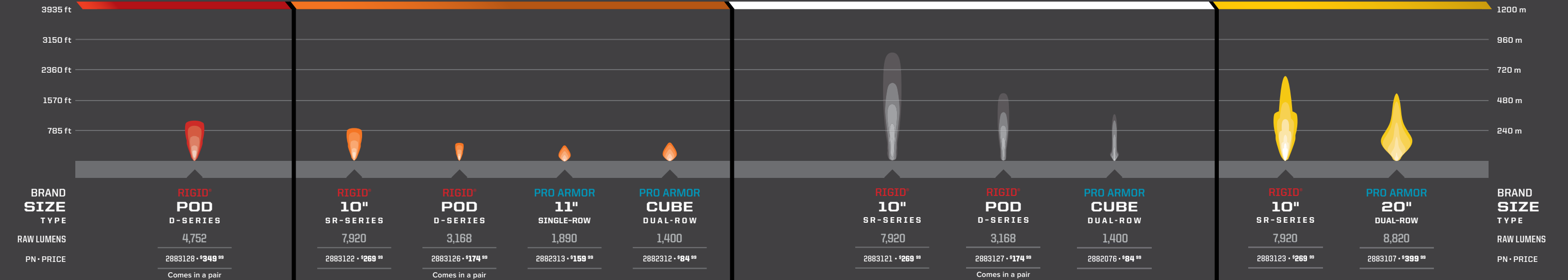

**BUILD YOUR VISION**

Consider the Optics, Angle & how you will use your vehicle to choose the right light or set of lights.

OPTICS LIGHT ANGLE	ACCENT	DRIVING (45°)	FLOOD (25°)	SPOT (10°)	COMBO (25°/10°)
DRIVING SPEED	All	Slow	Medium	Fast	Medium to fast
BEAM	Diffused glow	Extra-wide	Wide/Shorter	Concentrated/Long	Inner spot & outer flood
RECOMMENDED MOUNTING	Low/Wheel well	All points	Low &/or rear	High points	All points
TERRAIN & RIDING STYLE	Added style & personalization in any terrain	All riding & utility	Wide-open terrain or trails & utility	Trail & tight conditions	All riding & utility

COMPARE LIGHTS IN A REAL WORLD SETTING AT [POLARIS.COM/LIGHTING](http://POLARIS.COM/LIGHTING)

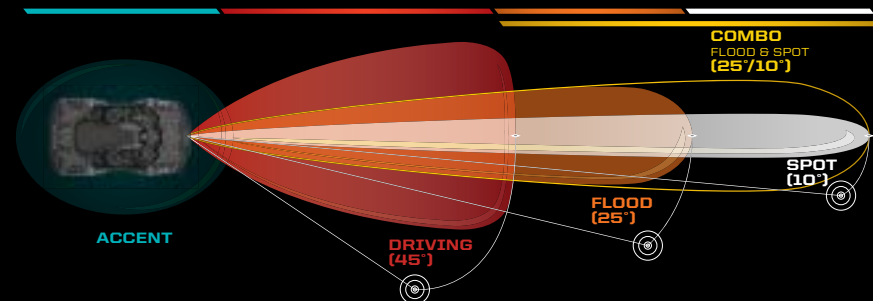

**LED LIGHTING**



**NEW LED LIGHT KIT**

Upgrade your standard headlights and pod lights to LEDs with this upgrade kit

» 2884859 · \$399<sup>99</sup>  
XP 1000 '21, 850 '21, 570 '21, 450 H.O '21

**ACCENT LIGHTING**

**ACCENT LIGHT KIT**

- Durable off-road ready construction that is both dust- and water-resistant
- Features CREE® LED for a long-lasting, brilliant light
- Set includes four LED pods

COLOR	LIGHTING KIT
RED	2880500 · \$159 <sup>99</sup>
BLUE	2880506 · \$159 <sup>99</sup>

**WIRING HARNESSES**

**LIGHTBAR HARNESS**

- Control one light with one switch
- » 2882320 · \$54<sup>99</sup>  
ALL SPORTSMAN MODELS

**LED Y-HARNESS**

- Y-Harness requires 2882320 to control two cubes or two lights with one switch
- » 2879860 · \$15<sup>99</sup>  
ALL SPORTSMAN MODELS

\* If RIGID® determines, in its sole discretion, that your product is defective in material or workmanship, RIGID® will honor your warranty claim. In some cases the product will be replaced, depending on the specific timeframe of the purchase. If the product is repaired, all parts, labor, and return shipping may be covered by RIGID®.

COMMON

WITCHES

450-570

850-XP1000-XP1000S

SPRAMELERS 850-XP1000S

MISC & YOUTH

WHEELS & TIRES

TRACKS & PLOW

LIGHTING

HUNT & COOLERS



# PROTECTING YOUR ESSENTIAL GEAR SINCE 1943

## KOLPIN STRONGHOLD SYSTEM

Polaris is proud to partner with Kolpin Outdoors, an industry leader in off-road accessories and the premier name in gun boots and mounts. If you need to secure a firearm while riding, simply attach the auto-latch mount and choose your case.

### IDEAL FOR SECURE TRANSPORT OF SCOPED RIFLES AND SHOTGUNS

#### STEP 1 CHOOSE YOUR MOUNT



##### AUTO-LATCH BOOT MOUNT

- Precision angle adjustable for a custom fit
- Provides a quick and secure attachment point

» 2882272 • \$69<sup>99</sup>  
XP 1000 S '20-21, XP 1000 '17-21, 850 '17-21  
Does not fit with bodyguard Brushguard (2882090)

##### **NEW** GUN BOOT MOUNT

- The Auto-latching design provides quick and secure Kolpin Stronghold product attachment
- Bracket is made from rugged high impact, reinforced nylon and coated steel with precision angle adjustment for a custom fit
- For use with the Kolpin Stronghold line of products (sold separately)

» 2884846 • \$69<sup>99</sup>  
570 '21, 450 H.O. '21

#### STEP 2 CHOOSE YOUR BOOTS



##### GUN BOOT XL – TRANSPORT

- Lockable and TSA Approved
- 52" L x 3 3/4" W x 10 1/2" H

» 2882430 • \$99<sup>99</sup>  
XP 1000 S '20-21, XP 1000 '17-21, 850 '17-21, 570 '19-21, 450 H.O. '21  
Requires Auto-Latch Mount (2882272 or 2884846)

##### GUN BOOT L

- 52" L x 4 3/4" W x 9 3/4" H

» 2882426 • \$59<sup>99</sup>  
XP 1000 S '20-21, XP 1000 '17-21, 850 '17-21, 570 '14-21, 450 H.O. '19-21  
Requires Auto-Latch Mount (2882272 or 2884846)



## KOLPIN RHINO GRIP

IDEAL FOR CARRYING RIFLES, SHOTGUNS, BOWS AND CROSSBOWS.



##### LOCK & RIDE

#### RHINO GRIP PRO

- » 2884119 • \$79<sup>99</sup>
- » 2884109 • REPLACEMENT RUBBER STRAPS • \$7<sup>99</sup>  
ALL SPORTSMAN MODELS (EXCEPT UTILITY EDITIONS & YOUTH)



##### LOCK & RIDE

#### RATCHETING RHINO GRIP

- » 2881157 • \$59<sup>99</sup>  
XP 1000 '15-21, X2 570 '15-21, TOURING XP 1000 '15-21, TOURING 850 '10-20, TOURING 570 '14-21, 850 '09-21, 6X6 570 '17-21, 570 '14-21, 450 H.O. '12-21



##### **NEW** LOCK & RIDE

#### RHINO GRIP XLR

- » 2889147 • \$34<sup>99</sup>
- » 2889204 • HEAVY-DUTY XLR REPLACEMENT RUBBER STRAPS (2) • \$7<sup>99</sup>  
ALL SPORTSMAN MODELS (EXCEPT UTILITY EDITIONS & YOUTH)



##### **NEW** LOCK & RIDE

#### RHINO GRIP XLR – DOUBLES

- » 2889148 • \$59<sup>99</sup>
- » 2889204 • HEAVY-DUTY XLR REPLACEMENT RUBBER STRAPS (2) • \$7<sup>99</sup>  
ALL SPORTSMAN MODELS (EXCEPT UTILITY EDITIONS & YOUTH)

#### KOLPIN GUN BOOT IV

- For 50mm scopes, rifles with slings attached, or shotguns up to 51" in length
- » BLACK • 2872677 • \$59<sup>99</sup>
- » MOSSY OAK® BREAK-UP® • 2872677-419 • \$89<sup>99</sup>



##### LOCK & RIDE GUN BOOT MOUNTS

- High-impact case secures firearm over any terrain
- Works with Lock & Ride XL Storage Box, Lock & Ride Rear Cargo Box, and Rear Rack Extenders

» 2878001 • \$124<sup>99</sup>  
TOURING XP 1000 '15-21, TOURING 850 '10-20, TOURING 570 '21



**KEEP IT  
ICE COLD**

**GRIZZLY TESTED.  
POLARIS APPROVED.**



This cooler is IGBC-approved, meaning it withstands the power expended by a typical grizzly bear if it was trying to get inside.

Seriously, there are experts who know what a grizzly is capable of doing, and they certify our coolers can take it.



**30, 60 & 105  
QUART FEATURES**



Comfort Carry Handles



Travel Lock System



EasyOut Drain System



No Slip Rubber Feet



PolarWall Insulation



Ice Lock Seal

**POLARIS NORTHSTAR COOLERS CAN SURVIVE JUST ABOUT ANYTHING - FROM EXTREME HEAT TO A NASTY TUMBLE OFF A VEHICLE.**



105 QUART

- » GRAPHITE • 2883426 • **\$399<sup>99</sup>**
- » DESERT • 2883392 • **\$399<sup>99</sup>**



60 QUART

- » GRAPHITE • 2883425 • **\$309<sup>99</sup>**
- » DESERT • 2881259 • **\$309<sup>99</sup>**



30 QUART

- » GRAPHITE • 2883424 • **\$239<sup>99</sup>**
- » DESERT • 2881315 • **\$239<sup>99</sup>**



15 QUART

- » GRAPHITE • 2883968 • **\$189<sup>99</sup>**



20 QUART SOFTSIDED COOLER

- » GRAPHITE • 2883390 • **\$159<sup>99</sup>**

**HOLDS ICE  
30+  
HOURS  
LONGER  
THAN YETI®\***

\*YETI is a registered trademark of YETI COOLERS, LLC

**ESSENTIAL ACCESSORIES SO YOUR COOLER WORKS AS HARD AS YOU DO**

COOLER ACCESSORIES	105 QUART	60 QUART	30 QUART	DON'T FORGET THESE ACCESSORIES	
<p><b>WIRE BASKET</b></p>	2883648 • <b>\$41<sup>99</sup></b>	2882185 • <b>\$30<sup>99</sup></b>	2882438 • <b>\$25<sup>99</sup></b>	<p><b>TUMBLERS</b></p> <p>30 oz</p> <ul style="list-style-type: none"> <li>» 30 OZ • 2883394 • <b>\$25<sup>99</sup></b></li> <li>» 20 OZ • 2883393 • <b>\$20<sup>99</sup></b></li> </ul>	<p><b>BOTTLE OPENER</b></p> <ul style="list-style-type: none"> <li>» 2882183 • <b>\$10<sup>99</sup></b></li> <li>ALL COOLERS</li> </ul>
<p><b>DIVIDERS</b> Doubles as cutting board</p>	2883468 • <b>\$30<sup>99</sup></b> COMES WITH ONE DIVIDER 	2882184 • <b>\$41<sup>99</sup></b> COMES WITH TWO DIVIDERS 	2882186 • <b>\$20<sup>99</sup></b> COMES WITH ONE DIVIDER 		
<p><b>SEAT CUSHION</b></p>	NOT AVAILABLE	2882179 • <b>\$84<sup>99</sup></b>	2882507 • <b>\$64<sup>99</sup></b>		
<p><b>WHEELS</b></p>	2883967 • <b>\$89<sup>99</sup></b>	2882180 • <b>\$94<sup>99</sup></b>	NOT AVAILABLE		



# FOR THE LIFE OF YOUR RIDE

**POLARIS ENGINEERS PARTS THAT PUSH THE LIMITS WITHOUT SACRIFICING STRENGTH AND DURABILITY.** We build our products so anyone with the right tools can maintain their vehicle from their own garage - and get them back on the trails where they belong.

## MAINTENANCE TIP

### BREAK-IN PERIOD

The break-in period for your new Sportsman is the first 25 hours of operation, or the time it takes to use the first two tanks of fuel. No single action on your part is as important as a proper break-in period. Careful treatment of a new engine will result in more efficient performance and longer life for the engine.

NOTICE: Excessive heat build-up during the first three hours of operation will damage close-fitted engine parts. Do not operate at full throttle or high speeds for extended periods during the first three hours of use.

SEE OUR LATEST MAINTENANCE TIPS AT [ATV.POLARIS.COM/EN-US/SELF-HELP](http://ATV.POLARIS.COM/EN-US/SELF-HELP)

### BATTERIES

To ensure a battery maintains its level of charge when unused for extended periods of time or during freezing weather, the battery should be connected to a BatteryMINDER™, P. 64. Be sure to check for corrosion from the terminals to the ends of the cables.

### BRAKE PADS

Maintaining and/or replacing brakes are critical to the safety and functionality of a vehicle. Brake pads should be checked for wear and oil or grease (petroleum products) contamination and brake discs should be checked for cracks, excessive corrosion or warping.

### HALF SHAFT

Check for tear and punctures in the boot which can lead to CV joint wear that can contribute to axle failure.

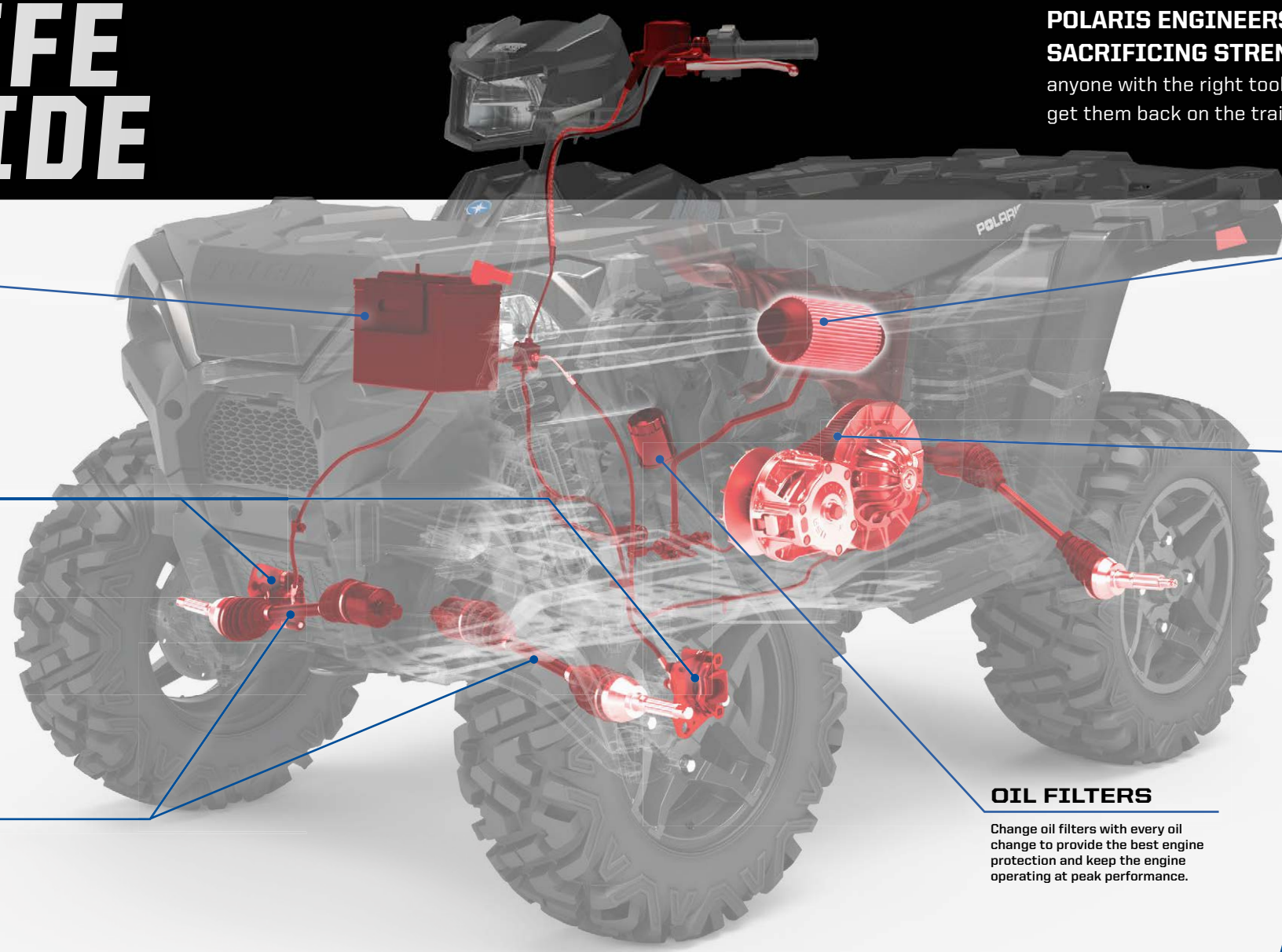

### AIR FILTERS

A clogged air filter can restrict air flow to the engine leading to reduced engine performance, engine life or catastrophic failure.

### DRIVE BELTS

Polaris Engineered belts deliver unmatched performance for your off-road vehicle. Developed and tested on all our engines for all environments and conditions. Check your belt for delamination, hour glassing and glazing.

#### BREAK-IN PERIOD

- Use lower gear (if available) while varying speeds and avoiding wide open throttle for 5-10 miles
- If no low gear is available, vary at moderate speeds while avoiding wide open throttle for 50 miles

#### OUR INVESTMENT

- 20,000 miles of field testing
- Thousands of dyno hours
- 18+ months of development (3,000+ design hours) per belt
- 1200+ vehicle validation hours
- Collaboration with powertrain & clutch engineers

#### YOUR ADVANTAGE

- No clutch recalibration
- Less wear & tear due to heat
- Ensure maximum vehicle performance
- More time riding, less time wrenching
- Produced in collaboration with powertrain and clutch engineers to ensure a perfect fit, maximum performance and ultimate durability

### OIL FILTERS

Change oil filters with every oil change to provide the best engine protection and keep the engine operating at peak performance.

**FOLLOW RECOMMENDED SERVICE INTERVALS IN THE OWNER'S MANUAL**

## MAINTENANCE SCHEDULE

25 HRS / 250 MI	50 HRS / 500 MI	100 HRS / 1000 MI	150 HRS / 1500 MI	200 HRS / 2000 MI	250 HRS / 2500 MI	300 HRS / 3000 MI	CHECK YOUR OWNER'S MANUAL FOR ADDITIONAL RECOMMENDED SERVICE ITEMS AND VEHICLE-SPECIFIC TIMING
<b>BREAK-IN MAINTENANCE</b> <b>ENGINE OIL:</b> CHANGE <b>GENERAL LUBRICATION:</b> ALL FITTINGS, PIVOTS, CABLES, ETC. <b>GEARCASES:</b> CHECK OIL LEVEL <b>AIR FILTER:</b> INSPECT & REPLACE AS NEEDED <b>EXHAUST SYSTEM:</b> INSPECT & CLEAN <small>INSPECT FOR LEAKAGE OR CARBON BUILD UP AT JOINTS</small> <small>INSPECT &amp; CLEAN SCREEN TYPE SPARK ARRESTOR</small>	<b>6 MONTHS</b> <b>EXHAUST SYSTEM:</b> INSPECT & CLEAN <small>INSPECT FOR LEAKAGE OR CARBON BUILD UP AT JOINTS</small> <b>DRIVE BELT:</b> INSPECT & ADJUST <small>REPLACE AS NEEDED</small> <b>GENERAL LUBRICATION:</b> ALL FITTINGS, PIVOTS, CABLES, ETC. <b>DRIVE BELT:</b> INSPECT & ADJUST <small>REPLACE AS NEEDED</small>	<b>12 MONTHS</b> <b>ENGINE OIL:</b> CHANGE <b>DRIVE BELT:</b> INSPECT & ADJUST <small>REPLACE AS NEEDED</small> <b>EXHAUST SYSTEM:</b> INSPECT & CLEAN <small>INSPECT FOR LEAKAGE OR CARBON BUILD UP AT JOINTS</small> <small>INSPECT &amp; CLEAN SCREEN TYPE SPARK ARRESTOR</small>	<b>18 MONTHS</b> <b>BATTERY:</b> TEST, CLEAN, & CHECK FLUID LEVEL <small>REPLACE AS NEEDED</small> <b>DRIVE BELT:</b> INSPECT & ADJUST <small>REPLACE AS NEEDED</small> <b>TIRES:</b> INSPECT CONDITION & PRESSURE <b>EXHAUST SYSTEM:</b> INSPECT & CLEAN <small>INSPECT FOR LEAKAGE OR CARBON BUILD UP AT JOINTS</small> <small>INSPECT &amp; CLEAN SCREEN TYPE SPARK ARRESTOR</small>	<b>24 MONTHS</b> <b>ENGINE OIL:</b> CHANGE <b>TRANSMISSION FLUID:</b> CHANGE <b>GEARCASES:</b> CHECK OIL LEVEL <b>BRAKE PADS &amp; FLUID:</b> INSPECT & CLEAN <small>REPLACE AS NEEDED</small> <b>SPARK PLUGS:</b> INSPECT <small>REPLACE AS NEEDED</small> <b>EXHAUST SYSTEM:</b> INSPECT & CLEAN <small>INSPECT FOR LEAKAGE OR CARBON BUILD UP AT JOINTS</small> <small>INSPECT &amp; CLEAN SCREEN TYPE SPARK ARRESTOR</small>	<b>30 MONTHS</b> <b>ENGINE OIL:</b> CHANGE <b>BATTERY:</b> TEST, CLEAN, & CHECK FLUID LEVEL <small>REPLACE AS NEEDED</small> <b>DRIVE BELT:</b> INSPECT & ADJUST <small>REPLACE AS NEEDED</small> <b>GENERAL LUBRICATION:</b> ALL FITTINGS, PIVOTS, CABLES, ETC. <b>EXHAUST SYSTEM:</b> INSPECT & CLEAN <small>INSPECT FOR LEAKAGE OR CARBON BUILD UP AT JOINTS</small> <small>INSPECT &amp; CLEAN SCREEN TYPE SPARK ARRESTOR</small>	<b>36 MONTHS</b> <b>ENGINE OIL:</b> CHANGE <b>AIR FILTER:</b> INSPECT & REPLACE AS NEEDED <b>GEARCASES:</b> CHECK OIL LEVEL <b>EXHAUST SYSTEM:</b> INSPECT & CLEAN <small>INSPECT FOR LEAKAGE OR CARBON BUILD UP AT JOINTS</small> <small>INSPECT &amp; CLEAN SCREEN TYPE SPARK ARRESTOR</small>	<b>CHECK YOUR OWNER'S MANUAL FOR ADDITIONAL RECOMMENDED SERVICE ITEMS AND VEHICLE-SPECIFIC TIMING</b>



**FOR THE LIFE OF YOUR RIDE ONLY THE BEST WILL DO**

To create the best oil for any terrain, we invest in rigorous testing to ensure our oil delivers the consistency and performance you demand.

**WHAT COUNTS IN OIL TESTING:**

1. Does it protect the engine at high temperatures?
2. Does it keep the engine free from carbon and buildup?
3. Does the oil hold its viscosity over time?

**ENGINE CHECKPOINTS**

Polaris engineers focus on key areas within the engine when evaluating engine oil and its ability to protect the life of your ride. Critical checkpoints include:



**PISTON RINGS & RING LANDS:** Extreme pressure to these parts require high lubricant film strength. Poor oxidative performance can lead to carbon and varnish buildup, which results in poor ring seal and fuel dilution of the oil. These can result in loss of power and accelerated engine wear.



**ROD BEARINGS:** Engine bearings on an oil with low film strength and thinner viscosity can lead to premature wear or even engine failure.



**CAMSHAFT:** Direct acting overhead camshafts are used on many Polaris engines. In this application the camshaft pushes directly on the valve, creating very high contact pressures compared to other camshaft configurations. These forces are so great that inferior oil can break down leading to increased wear and potential engine damage.

100 HR Polaris Endurance Dynamometer Engine Test Platform: RZR 1000 Oil Used: PS-4 5W50

**SPECIFIC NEEDS,  
SPECIFIC OILS**

**PS-4 FULL-SYNTHETIC OIL**

PS-4 is optimal for ambient operating temperatures of -40° F to 100° F

**OUR FORMULATION**

- Full-synthetic formula with wide, 5W-50 viscosity range
- Extreme cold weather flow and startup protection
- Maximum rust and corrosion protection
- Proprietary anti-wear additive system

**YOUR ADVANTAGE**

- All-weather engine protection
- Easy starting in all conditions
- Internal engine protection from extreme temperature fluctuations and periods of non-use or storage
- Reduced friction, protects cams, pistons, bearing and valvetrain components from wear

**PS-4 EXTREME-DUTY FULL-SYNTHETIC OIL**

PS-4 Extreme Duty is optimal for ambient operating temperatures of 0° F to 130° F

**OUR FORMULATION**

- Extreme high-temperature engine protection
- Full-synthetic formula with strong, 10W-50 Viscosity Range
- Protects against rust and corrosion of internal engine parts during periods of non-use or storage

**YOUR ADVANTAGE**

- High-strength film protection withstands extreme heat, stress and sustained high RPM conditions
- Extremely shear stable, maintains viscosity under heat and stress
- Protects engine from moisture that can build up inside the engine as a result of extreme temperature fluctuations

**OIL CHANGE KITS**

These convenient kits include everything you need to change your oil. The correct filter and oil volume for your vehicle.

PS-4	PS-4 EXTREME DUTY	
PART NUMBER	VEHICLE FITMENT	PART NUMBER
2202166	RANGER/RZR/SPORTSMAN 570, TWIN 600, TWIN 700, TWIN 800	2879004
2879323	RANGER, POLARIS GENERAL, RZR 900/1000, RS1	2879324
2877473	RANGER/ SPORTSMAN 300-500, SPORTSMAN/SCRAMBLER 500/850/1000	2878924
2881696	RZR TURBO	2881697

- › 1 Quart 2876244
- › 1 Gallon 2876245
- › 16 Gallons 2876247
- › 55 Gallon Drum 2876246
- › 330 Gallon Tote 2878814

- › 1 Quart 2878920
- › 1 Gallon 2878919
- › 16 Gallons 2879003
- › 55 Gallon Drum 2879002
- › 330 Gallon Tote 2879001

**SUPERIOR ENGINE PROTECTION**

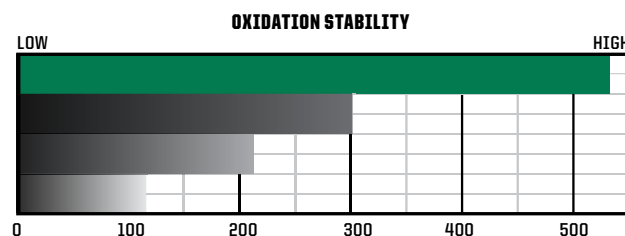

**Higher Number = Longer Oil Life**  
Polaris proprietary additive system resists the negative effects of oil oxidation longer than leading aftermarket and automotive engine oils.

**CLEAN ENGINE, LOWER DEPOSITS**

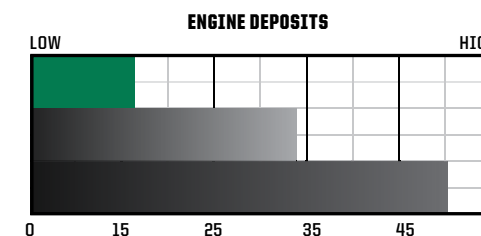

**Clean Engine Test**  
Lower Number = Less Deposits, Cleaner Engine Operates at Peak Performance.  
ASTM Test D6335

**OIL DEVELOPMENT**

POLARIS INVESTS IN EACH OIL AT AND ABOVE THESE LEVELS.

POLARIS.COM/ShopSPORTSMAN

**12 DEDICATED  
TEAM MEMBERS**

**FOCUSED ON  
POLARIS OIL**

**18+  
MONTHS**

**DEVELOPMENT  
& TESTING**

**75,000+  
HOURS**

**DYNO TESTING**

**1.8 MILLION  
MILES**

**FIELD TESTING**



# MAINTENANCE FLUIDS



## DOT 4 BRAKE FLUID

A high-quality brake fluid designed for use in Polaris hydraulic brakes.

Change every 200 hours, 2000 miles or every 24 months.

» 12 OZ. • 2872189



## AGL

Protect gears, drive chain, and bearings from scoring and wear.

Change every 200 hours, 24 months or 2000 miles.

» 1 QT. • 2878068  
» 1 GAL. • 2878069  
» 2.5 GAL. • 2878070  
» 55 GAL. • 2879594



## ORV MAINTENANCE KIT

• Everything you need, in the correct fluid volumes, to maintain your drive train, and keep your vehicle in top operating condition

• Includes: 1.5 qts. AGL, 1 qt. Angle Drive Fluid, 1 pint Demand Drive Fluid, 1-3 oz. tube of All-Season Grease

» 2880425



## ENGINE OIL

Maximum protection for your 4-cycle engine.

Change every 100 hours, 1000 miles or 12 months.

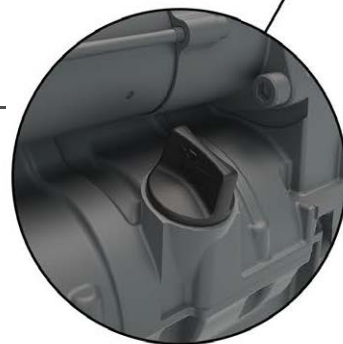

## ANTI-FREEZE

Prevent corrosion on metal components, eliminate scaling, and maximize cooling system performance.

Change every 60 months.

» 1 QT. • 2880514  
» 1 GAL. • 2880513  
» 55 GAL. • 2880512



## DEMAND DRIVE FLUID

Provide positive 4WD engagement in extreme cold or high head conditions and protect internal components under heavy loads.

Change every 100 hours or every 36 months.

» 1 QT. • 2877922  
» 2.5 GAL. • 2877923



## SUSPENSION/ U-JOINT GREASE

A heavy-duty lubricant formulated with molybdenum disulfide to accept the high shock applications of Polaris ATV shaft drive universal joints.

Add every 50 hours, 3 months or 500 miles.

» 3 OZ. • 2871515  
» 14 OZ. • 2871551



# LUBRICANT ACCESSORIES



## NEW OIL FILTER WRENCH

• Remove Polaris ORV oil filters with ease.  
» 2830550 • \$7<sup>99</sup>



## NEW FLUID FUNNEL

• Easily add oil with high accuracy.  
» 2830552 • \$12<sup>99</sup>



## NEW FLUID TRAY

• Holds up to 8 quarts of fluid.  
» 2830551 • \$19<sup>99</sup>



## NEW FLUID SYRINGE

• Easily add and remove fluid from your vehicle.  
» 2830553 • \$29<sup>99</sup>



## GREASE GUN

» Enables easy application of grease.  
» 2871312 • \$39<sup>99</sup>  
FITS 2871322 ALL-SEASON AND 2871515 U-JOINT 3 OZ.



## 2D BATTERY-OPERATED SIPHON PUMP

• Liquid transfer pumps 5-6 quarts/min suctioning power.  
» 2830513 • \$16<sup>99</sup>



## FLEX SPOUT

• Fits all Polaris quart, gallon and 2.5 gallon bottles.  
» 2871285 • \$3<sup>99</sup>



## PUMP

• Fits 1 and 2.5 gallon bottles.  
» 2870465 • \$7<sup>99</sup>



## PREMIUM GAS SHOCK OIL

• Specialized shear stable blend containing high levels of anti-wear anti-foam & oxidation

» 1 QT. • 2870995  
» 2.5 GAL. • 2872279  
FOX® REBUILDABLE SHOCKS



## 10WT GAS SHOCK OIL

• Specialized fluid to ensure proper gas shock absorber action

» 1 QT. • 2874124  
WALKER EVANS® REBUILDABLE SHOCKS



## CHAIN LUBRICANT

• Provides superior anti-wear and shock protection

» 16 OZ. AEROSOL 2872348



## ALL-SEASON GREASE TUBE

• Specialized water resistant lubricant

» 3 OZ. • 2871322  
» 14 OZ. • 2871423



## ANGLE DRIVE FLUID

• Extreme pressure, anti-wear and high viscosity film lubrication for maximum protection

» 1 QT. • 2876160  
» 2.5 GAL. • 2872276  
SPORTSMAN, RANGER, RZR ANGLE DRIVE GEAR CASE SYSTEMS



## GENERATOR OIL

• 4-Cycle Engine Oil

» 1 QT. • 2879383



## CARBON CLEAN

• Ultimate fuel and injection system cleaner

» 12 OZ. • 2881413



## ADVANCED FUEL TREATMENT

• Dual Antioxidant formula protects jets and fuel system from gum and varnish

» 12 OZ. • 2881416  
» 2.5 GAL. • 2881417



# SERVICE PARTS

Polaris Engineered service parts deliver unmatched performance and fit for your off-road vehicle.

All service parts are engineered specifically for your machine. Which means everything is designed, tested and perfected to maximize the life of your ride. Getting Polaris Engineered parts is a decision that pays off in the long run, because it ensures there is a long run.



SHOP FOR SERVICE PARTS ONLINE OR VISIT YOUR POLARIS DEALER.

CHECK OUT OUR PARTS FINDER ON POLARIS.COM FOR EASY PARTS LOOK-UP, PARTS IDENTIFICATION, VIEWS OF ASSEMBLIES & MORE!

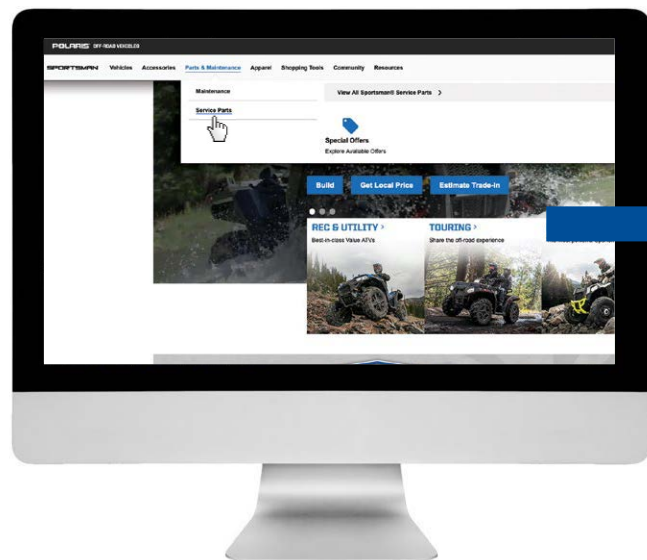

## STEP 1

Visit [Polaris.com/SPORTSMAN](https://www.polaris.com/SPORTSMAN)  
Click "Parts & Service" tab  
Click "Service Parts"

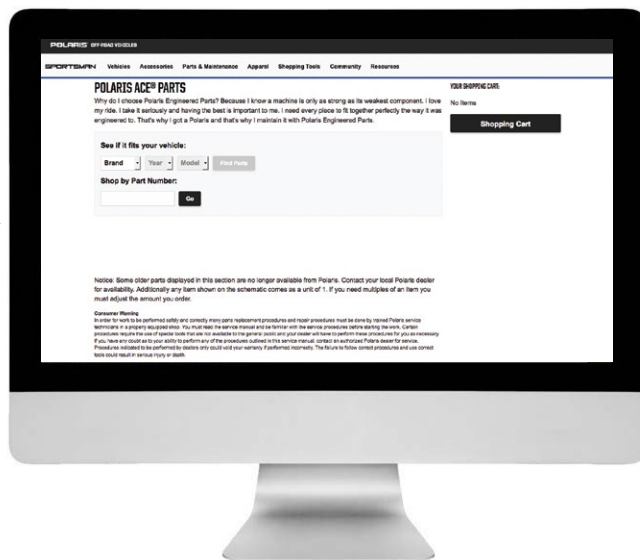

## STEP 2

Enter **vehicle year/model** or shop by **part number**



## STEP 3

Clearly see what parts are required and **order**

**Assembly**  
DRIVE TRAIN, FRONT HALF SHAFT - A17DAA50A7 (100044)

A17DAA50A7 ACE 500 60HC (2017) (R14)

Tag	Part #	Description	Price	Qty	
1	1333246	ASM-SHAFT,HALF,FRONT	\$249.99	2	Add
2	2205801	K-JOINT,CV   [INCL. BALL, INTER RACE, CAGE, BELL]	\$74.99	1	Add
3	2205802	K-BOOT,OUTER   [INCL. CLAMPS, BOOT, GREASE]	\$49.49	1	Add
4	2205803	K-HALF-SHAFT BAR   [INCL. SHAFT, CLIPS]	\$99.99	1	Add
5	2205804	K-BOOT,INNER   [INCL. CLAMPS, BOOT, GREASE]	\$39.99	1	Add
6	2205805	K-DOJ,INNER   [INCL. CLIP, RING, RACE, BALLS, BELL]	\$89.49	1	Add
7		KIT, SNAP RING SET			Contact Dealer
8		GREASE			Contact Dealer

Notice: Some older parts displayed in this section are no longer available from Polaris. Contact your local Polaris dealer for availability. Additionally any item shown on the schematic comes as a unit of 1. If you need multiples of an item you must adjust the amount you order.



OVER  
**100,000**  
PARTS  
AVAILABLE!

PARTS & GARAGE

MAINTENANCE

OIL & LUBRICANTS

MAINTENANCE FLUIDS

SERVICE PARTS

HO PARTS

BATTERIES & TIRE SEALANT

VEHICLE CARE & TRAILERING

POLARIS POWER

TRAILERING

TRAILERING

61



# HD HEAVY DUTY PARTS



All Polaris parts are developed and tested to help you get the most out of your ride. Now, we're taking the passion of our riders, workers, and outdoor enthusiasts to the next level with HD Parts.

Engineered & designed for:

- Greater durability
- Enhanced performance
- Greater wear & tear capabilities
- All weather conditions

## NEW WHEEL BEARINGS

Fully sealed for added protection against intrusions. Made of a higher grade steel for extended life in extreme conditions.

LOCATION	OE	HD HEAVY DUTY PARTS
FRONT WHEEL BEARINGS	3514822	3515090
	3514634	3515088
REAR WHEEL BEARINGS	3514917	3515087



## NEW BUSHING KITS

Easily update the entire front and rear suspension.

- » 2830562 (SHOWN)  
570 EFI '16-'20, 570 EFI X2 '16-'20, 570 EFI TOURING '16-'20, 570 EPS UTILITY '20, 450 HO '16-'20, 450 UTILITY '20
- » 2830563  
570 SP '16-'19, 570 PREMIUM '19, 570 SP TOURING '16-'20



## NEW BUSHINGS

The advanced material compound of the bushings enables tighter tolerances to reduce overall wear on the system, while the superior triple lip sealing prevents intrusion of the elements.



## NEW WHEELS & TIRES

Class leading durability for off-road performance and traction for confident driving in extreme conditions.

- » 1524022-458 • HD WHEEL - 14x7
- » 5457498-458 • HD WHEEL CENTER CAP



## COMING SOON BRAKES

Engineered to provide longer life and better stopping power while riding in extreme conditions.

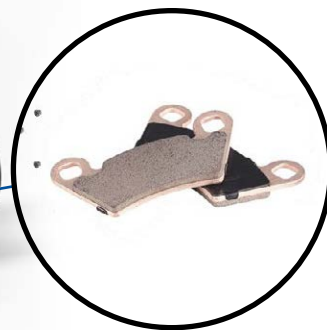

LOCATION	OE	HD HEAVY DUTY PARTS
FRONT UPPER BUSHINGS	5439874	1543367
FRONT LOWER BUSHINGS	5439874	1543367
	5436973	1543326
REAR UPPER BUSHINGS	5439874	1543367
	5438895	1543326
REAR LOWER BUSHINGS	5439874	1543367
	5436973	1543326

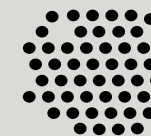

SAND



MUD



WATER



EXTREME COLD



EXTREME HEAT UP TO 130° F



HEAVY PAYLOADS



EXTENDED LIFE

PARTS & GARAGE

MAINTENANCE

OIL & LUBRICANTS

MAINTENANCE FLUIDS

SERVICE PARTS

HD PARTS

BATTERIES & TIRE SEALANT

VEHICLE CARE & TRAILERING

POLARIS POWER

\*Claims made based off testing and performance of Polaris HD Parts against standard OEM parts made by Polaris and competitor brands under normal use.

For more information regarding Polaris HD parts including vehicle compatibility, installation, and maintenance, please contact your authorized Polaris ORV dealer.

VISIT [POLARIS.COM/HDPARTS](https://www.polaris.com/hdparts) TO LEARN MORE





# BatteryMINDER®

ENSURE YOUR RIDE IS READY WHEN YOU ARE.

- Add years of capacity, power and range to new and older batteries, regardless of type or brand
- Never over- or under-charged in any temperature
- Leave your vehicle connected for months and return to fully charged and conditioned batteries
- Recover older or weak batteries that would normally need to be replaced
- Charge and maintain extra backup batteries as well as those in your vehicle
- Automatic turn-on, sleeps while keeping your batteries at full charge
- Easy push-button selector to change battery type or time



	2012 AGM 2-AMP	2012 LEAD ACID 2 AMP	1510 1.5 AMP	1.5 AMP CONVERTIBLE
PART NUMBER   PRICE	2830438   \$99 <sup>99</sup>	2830531   \$89 <sup>99</sup>	2830404   \$64 <sup>99</sup>	2830511   \$74 <sup>99</sup>
VOLTAGE   WARRANTY	12 V   5 Years	12 V   5 Years	12 V   10 Years	12 V   5 Years
CHARGING CURRENT	2AMP	2AMP	1.5AMP	1.5AMP
OVERCHARGE PROTECTION	Yes			
BATTERIES MAINTAINED	6 at one time		4 at one time	
BATTERY COMPATIBILITY	12 V Sealed AGM Lead-Acid	12 V Flooded (filler cap) and Sealed Maintenance-Free Batteries		
COMES WITH	• Non-fused battery clip cord set with Quick Connector	• BC-2410: 2' Non-fused battery clip cord set with Quick Connector • RTA-2415: 2' Fused ring terminal cord set with Quick Connector • ATS-1: Ambient Temperature Sensor	• Ambient temperature sensor (installed) • 12' power cord • Battery clip cord set with Quick Connector	• Auto-temp compensation sensor (installed) • Optional permanent mounting brackets & screws • Battery clips (fully-insulated, aircraft grade, 15A replaceable fuse) • Ring terminal assembly with 15A replaceable fuse
KEY FEATURES	Designed for high-performance specialty AGM sealed batteries	Diagnoses battery's condition - can predict failing batteries	Easy to use, economical	Convertible on-vehicle or bench top use

## BATTERY MAINTENANCE TIPS

Extend your battery life with a BatteryMINDER® and these tips.

1. Store batteries in a cool, dry location.
2. Check that the battery connections are tight. Cables should not be able to be rotated or shifted by hand.
3. If your battery has a drain tube, make sure it is free of clogs.
4. Clean your battery - use a soft brush to scrub the top of the battery. Use baking soda to remove grease.
5. Connect a BatteryMINDER® after using your vehicle even if the vehicle is in regular use.

# TIRE SEALANT

## HOW IT WORKS

Tire sealant remains liquefied inside your tire until a leak develops in the tire or wheel.



Once a leak occurs, the tire sealant rushes out of the tire and quickly creates a permanent solid plug.

The plug maintains the pressure of the tire so you can continue your ride.



## HOW MUCH TIRE SEALANT DO YOU NEED?

$$\text{TIRE HEIGHT (IN.)} \times \text{TIRE WIDTH (IN.)} / 5 = \text{OUNCES REQUIRED PER TIRE}$$

Ex: 27" × 10" / 5 = 54 oz.

FOR A FULL APPLICATION CHART, VISIT [POLARIS.COM/TIRESEALANTCHART](http://POLARIS.COM/TIRESEALANTCHART)

### PREMIUM TIRE SEALANT

- Instantly seals and repairs rim, bead leaks, and punctures up to 1/4" on standard tires, and 3/4" on heavy ply tires
- Helps maintain air pressure for the life of the tire
- Helps seal the tire bead against the wheel
- 100% water soluble for easy cleanup
- Will not rust, corrode, or pit wheels
- Creates permanent repair
- Remains fluid and effective in temperatures down to -45° F
- Easily installed through existing tire valve stem with valve core removed

- » 32 OZ. • 2830484 • \$20<sup>99</sup>
- » 1 GALLON • 2830485 • \$72<sup>99</sup>
- » 5 GALLON • 2830486 • \$298<sup>99</sup>
- » 5 GALLON PUMP • 2830487 • \$133<sup>99</sup>
- » 55 GALLON • 2830489
- » 275 GALLON • 2830488

24 X 7 COVERAGE | BE PREPARED FOR ANYTHING

## BatteryMINDER® ACCESSORIES



### BatteryMINDER® 12' CABLE

- Made with heavy-duty 16 gauge black zip cord featuring automotive SAE bullet connectors

» 2830410 • \$12<sup>99</sup>



### BatteryMINDER® VPP-12:12/24 VOLT VEHICLE POWER PLUG

- Allows easy connection to vehicle's battery through lighter or 12/24V power port with replaceable 15 amp fuse

» 2830518 • \$9<sup>99</sup>



### BatteryMINDER® SPLITTER

- Connect two batteries simultaneously for easy battery maintenance
- Cap includes a set of ring terminals

» 2830409 • \$24<sup>99</sup>



### BatteryMINDER® RING TERMINAL

- Features 24-inch long 18-gauge wire
- Plug has standard 5/16" negative and 3/8" positive terminals
- Replaceable 15 amp in-line fuse for circuit protection

» 2830437 • \$9<sup>99</sup>



### BatteryMINDER® EZ CONNECT

- Allows for quick and easy connecting and disconnecting of your BatteryMINDER®
- Includes a set of ring terminals

» 2830411 • \$34<sup>99</sup>

## SHOP ACCESSORIES



### POLARIS X3 CREEPER

- Three positions: flat, 45-degree angle or seated work stool
- Helps you perform any repair with ease
- Stay dry and warm away from cold, wet cement floors
- Easily stores away when not in use

» BLACK • 2830429 • \$149<sup>99</sup>



### POLARIS MAGNETIC PARTS TRAY

» SILVER • 2830432 • \$12<sup>99</sup>



### POLARIS 33" TELESCOPIC MAGNET

» BLACK • 2830435 • \$4<sup>99</sup>



### POLARIS 12" HI-TORQUE RATCHETING DRIVER

» BLACK / BLUE • 2830434 • \$19<sup>99</sup>



### POLARIS LED POCKET FLASHLIGHT

» BLACK • 2830436 • \$24<sup>99</sup>



# CV BOOT REPAIR KIT

FIX ON THE GO | TEMPORARY COVERAGE

- A quick trail side fix to increase trail time
- The flexible and durable boot material expands over a cone tool for CV boot repairs, without disassembling CV axles
- Universal fit – works as a temporary fix for most powersports axles
- All components fit inside the cone, and a cover is provided for compact durable storage
- Easily fits in a cargo box, attached to the roll cage, in the glovebox, or many other storage locations



Items shown are contained inside cone

## ATV CV BOOT REPAIR KIT

Kit includes the following items:

- (1) Expandable CV Boot
- (1) Reusable Cone Tool
- (2) CV Boot Clamps
- (1) Tube of Silicone Lube
- (1) Grease Packet
- (1) Cone Cover

» 2830528 • \$25<sup>99</sup>

## ATV TRAIL BOOT ONLY

» 2830529 • \$14<sup>99</sup>

## UTV

» CV REPAIR KIT 2830526 • \$29<sup>99</sup>

» TRAIL BOOT ONLY 2830527 • \$14<sup>99</sup>

SEE HOW THE CV BOOT REPAIR KIT WORKS AT [POLARIS.COM/MAINTENANCE-VIDEOS](http://POLARIS.COM/MAINTENANCE-VIDEOS)

## HOW TO INSTALL

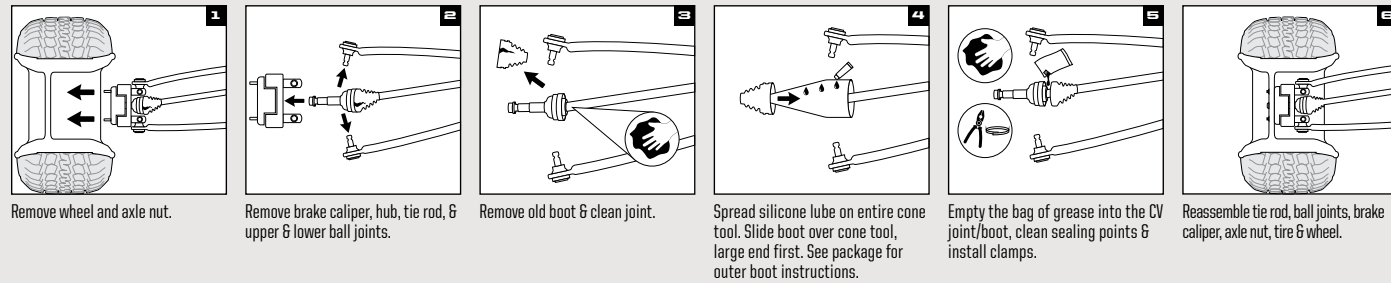

Refer to your service manual for further instructions and torque specifications.  
\*Designed for temporary CV boot repair. Purchase the OEM CV Boot for a permanent repair.

# KEEP IT CLEAN

## VEHICLE SHINE

### MUD SHIELD PRE-TREATMENT



- Inhibits the adhesion of dirt, mud, and snow, making cleaning your vehicle faster and easier.

» 16 OZ. AEROSOL • 2830208 • \$9<sup>99</sup>

### POLARIS POLISH



- Easy protection and shine—spray on, wipe off, and go. For ideal use on painted and plastic surfaces. Contains carnauba wax.

» 12 OZ. • 2830207 • \$7<sup>99</sup>

### VEHICLE & EQUIPMENT WASH



- Concentrated professional grade formula powers through vehicle buildup, dirt and grease with a spot-free rinse. Treat up to 32 gals. Biodegradable product.

» 1 GAL. • 2830417 • \$16<sup>99</sup>  
» 5 GAL. • 2830422 • \$59<sup>99</sup>

## SHOP

### POLARIS SHOP TOWELS



» 200 CT WITH DISPENSER (SHOWN) 2830402 • \$22<sup>99</sup>  
» 200 CT REFILL • 2830403 • \$15<sup>99</sup>  
» 64 CT REFILL • 2830440 • \$4<sup>99</sup>

### POLARIS HEAVY-DUTY SCRUBBER WIPES



» 90 CT • 2830441 • \$19<sup>99</sup>

### ALL-PURPOSE CLEANER PLUS



- Professional-grade formula removes built-up stains from shop floors, work benches, and other hard surfaces. VOC-free, environmentally-friendly, and biodegradable.

» 1 GAL. • 2830414 • \$16<sup>99</sup>  
» 5 GAL. • 2830416 • \$59<sup>99</sup>

### HD CLEANER & DEGREASER



- Professional-grade, biodegradable, high-foaming formula dissolves and removes tough stains and soils.

» 1 GAL. • 2830418 • \$19<sup>99</sup>  
» 5 GAL. • 2830420 • \$79<sup>99</sup>

# BRING IT EVERYWHERE

## TRAILERING



### CALIBER® RAMP PRO

- Designed for ATVs and UTVs up to 50" wide
  - Integrated grip glides for ultimate traction
  - Folding sides for easy transportation & storing
- » 52" x 90" • 2884576 • \$399<sup>99</sup>



### ALUMINUM ARCHED LOADING RAMPS

» 76" x 12" • 2,000 lb • 2875384 • \$219<sup>99</sup>  
» 88" x 12" • 3,000 lb • 2875386 • \$359<sup>99</sup>



### LIGHTWEIGHT TRI-FOLD RAMPS

- Ramp folds up for transport
  - Capacity for up to 1,500 lb
  - Safety straps included
- » 72" x 51" • 2875385 • \$239<sup>99</sup>  
» 82" x 51" • 2875860 • \$279<sup>99</sup>



### FOLDING ALUMINUM ARCHED RAMPS

- Ramp folds up for transport
  - Capacity up to 3,000 lb
  - Safety straps included
- » 88" x 12" • 2875387 • \$289<sup>99</sup>

## HITCHES

### 3:1 HITCHES VERSATILE 3 IN 1 FUNCTIONALITY

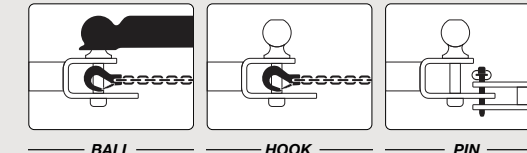

- Ball, pin and hook design
- Durable, rust resistant steel with black powdercoated finish
- Removable ball
- HD 5/8" pin and clip



### HITCH WITH 2" BALL

» 2" x 2" RECEIVER 2830522 • \$39<sup>99</sup>  
» 1 1/4" x 1 1/4" RECEIVER 2830523 • \$39<sup>99</sup>



### 1 7/8" BALL

- 1 7/8" replacement ball for hitch
- Designed to work with 3:1 Hitch

» 2830524 • \$9<sup>99</sup>



### RECEIVER HITCH

» 2" RECEIVER TONGUE 2875320 • \$41<sup>99</sup>  
» FRONT HITCH RECEIVER 2878846 • \$124<sup>99</sup>

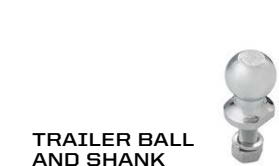

### TRAILER BALL AND SHANK

» 1 7/8" BALL • 2877602 • \$12<sup>99</sup>  
» 2" BALL • 2877603 • \$12<sup>99</sup>



### RECOVERY STRAP

- 2" x 30' (18,000 lb)
  - Comes with carry bag
- » 2884033 • \$54<sup>99</sup>



### RATCHET STRAP

- 1.5" x 15' straps, 2 Pack
  - Heavy duty webbing
  - 5,500 lb maximum load, 1,833 lb working load
- » 2884031 • \$41<sup>99</sup>



### RATCHET STRAP

- 2" x 20' Ratchet Straps
  - Heavy duty webbing, floating D-rings, double J-hooks
  - 10,000 lb maximum load, 3,300 lb working load
- » 2884032 • \$30<sup>99</sup>



### SHOCK STRAPS

- 1.5" 3,000 lb breaking strength
  - Keeps tension on tie-down straps to secure load, 2 Pack
- » 1.5" x 15' • 2883296 • \$79<sup>99</sup>  
» 1.5" x 7' • 2883295 • \$69<sup>99</sup>

## COVERS



### TRAILERABLE COVER

» 2876614 • \$159<sup>99</sup>  
ALL SPORTSMAN EXCEPT 300/400, XP 1000 S, SCRAMBLER XP 1000 S, X2, TOURING REPLACEMENT STRAP 2871912.

» 2877999 • \$159<sup>99</sup>  
ALL SPORTSMAN TOURING REPLACEMENT STRAP 2871912.

» 2884188 • \$169<sup>99</sup>  
XP 1000 S, SCRAMBLER XP 1000 S

PARTS & GARAGE

MAINTENANCE

OIL & LUBRICANTS

MAINTENANCE FLUIDS

SERVICE PARTS

HD PARTS

BATTERIES & TIRE SEALANT

VEHICLE CARE & TRAILERING

POLARIS POWER





<b>NEW</b> <b>P2000i</b> Inverter Generator	2830532	<b>\$799</b> 99	<b>1600</b> Running Watts	<b>2000</b> Starting Watts	<b>16.7</b> Max Amps at 120V	<b>7.6</b> Run Time at 25% Load w/ Smart Throttle (hrs)	<b>62</b> Noise Level at 25% Load (dBA)
---	---------	-----------------	------------------------------	-------------------------------	---------------------------------	--	--

**FEATURES**

- Extension Cord Management
- Multi Functional Digital Display
- Illuminated Control Panel
- Multi Handle Design
- Parallel Capable

**BEST USED FOR**

- Tailgating
- Off-Grid
- Camping



<b>ACCESSORIES</b>	2830536 INVERTER PARALLEL KIT	2884865 HIGH ALTITUDE MODIFICATION KIT
	2830540 ALL WEATHER COVER	2879383 GENERATOR OIL

<b>NEW</b> <b>P3200iE</b> Inverter Generator	2830533	<b>\$1599</b> 99	<b>2800</b> Running Watts	<b>3200</b> Starting Watts	<b>23.3</b> Max Amps at 120V	<b>10.1</b> Run Time at 25% Load w/ Smart Throttle (hrs)	<b>67</b> Noise Level at 25% Load (dBA)
--	---------	------------------	------------------------------	-------------------------------	---------------------------------	---	--

**FEATURES**

- Key Fob Remote Start
- Multi Functional Digital Display
- Fuel Gauge
- Extension Cord Management
- Parallel Capable

**BEST USED FOR**

- DIY Remodeling
- One Room Backup
- Camping



<b>ACCESSORIES</b>	2830536 INVERTER PARALLEL KIT	2884866 HIGH ALTITUDE MODIFICATION KIT
	2830541 ALL WEATHER COVER	2879383 GENERATOR OIL

POLARIS POWER is a registered trademark of Polaris Industries Inc. Read, understand and follow your owner's manual. Never operate a generator indoors. Generator exhaust contains carbon monoxide vapors and exposure can result in severe injury or death. Gasoline is highly flammable and explosive under certain conditions. Always use extreme care when handling gasoline.





<b>NEW</b> <b>P5500</b> Open Frame Generator	2830534	<b>\$1499<sup>99</sup></b>	<b>5000</b> Running Watts	<b>5500</b> Starting Watts	<b>20/30</b> Max Amps at 120/240V	<b>5</b> Run Time (hrs)	<b>75</b> Noise Level (dBA)
--	---------	----------------------------	------------------------------	-------------------------------	--------------------------------------	----------------------------	--------------------------------

**FEATURES**



Extension Cord Management



Fuel Gauge



Electric Start



Rough Terrain Wheel

**BEST USED FOR**



Construction



Home Backup



RV'ing



**ACCESSORIES**    2830542 ALL WEATHER COVER  
 2884867 HIGH ALTITUDE MODIFICATION KIT

2879383 GENERATOR OIL

<b>NEW</b> <b>P6500</b> Open Frame Generator	2830535	<b>\$1699<sup>99</sup></b>	<b>6000</b> Running Watts	<b>6500</b> Starting Watts	<b>20/30</b> Max Amps at 120/240V	<b>5</b> Run Time (hrs)	<b>75</b> Noise Level (dBA)
--	---------	----------------------------	------------------------------	-------------------------------	--------------------------------------	----------------------------	--------------------------------

**FEATURES**



Extension Cord Management



Fuel Gauge



Electric Start



Rough Terrain Wheel

**BEST USED FOR**



Construction



Home Backup



RV'ing



**ACCESSORIES**    2830542 ALL WEATHER COVER  
 2884867 HIGH ALTITUDE MODIFICATION KIT

2879383 GENERATOR OIL

VISIT [POLARISPOWER.COM](http://POLARISPOWER.COM)  
FOR ALL PRODUCT FEATURES



# RIDING GEAR



## OFF-ROAD RIDING JERSEYS

S-3XL | \$34.99

- Mesh ventilated panels for maximum airflow
- Elastic sleeves with non-restrictive cuffs

## OFF-ROAD RIDING GLOVES

S-3XL | \$24.99

- Adjustable wrist closure for a custom fit
- Silicon finger grips and neoprene knuckle protection

## YOUTH JERSEY

S-XL | \$26.99

- MULTICOLOR | 2860652
- BLUE | 2860651

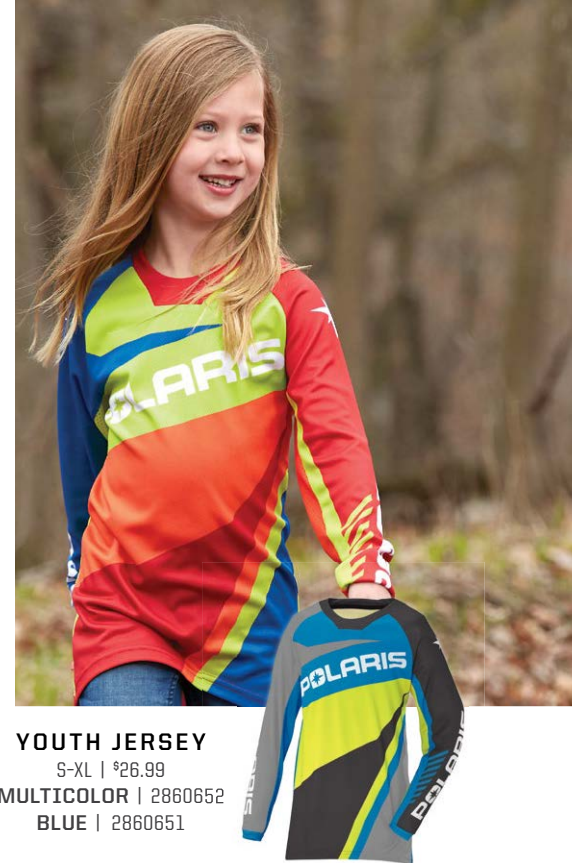

**BLACK**  
JERSEY | 2860646  
GLOVE | 2860641

**BLUE/LIME**  
JERSEY | 2860647  
GLOVE | 2860642

**MULTICOLOR**  
JERSEY | 2860648  
GLOVE | 2860643

**NAVY/PINK**  
JERSEY | 2860649  
GLOVE | 2860644

**RED**  
JERSEY | 2860650  
GLOVE | 2860645

## TEKVEST® ULTIMATE PROTECTION



**TEKVEST® SUPERSOFT**  
S-3XL | 2862190 | \$429.99

- Zip-off fleece collar diffuses rising body heat to reduce fogging
- Drop-tail design for extended coverage
- 2-stage pockets



**TEKVEST® FREESTYLE**  
S-3XL | 2862189 | \$349.99

- Strong, protective ultra high molecular weight panels cover shoulders
- Front and rear mesh panels promote cooling airflow



**TEKVEST® YOUTH**  
70-100 lbs | 2862191 | \$289.99

- Adjustable side straps and arm straps
- Strong, protective ultra high molecular weight panels cover shoulders

# COOLING SHIRTS

## MEN'S LONG SLEEVE COOLING SHIRT

S-3XL | 2860638 | \$44.99

## WOMEN'S LONG SLEEVE COOLING SHIRT

S-3XL | 2860640 | \$44.99



## FABRIC TECHNOLOGY DESIGNED TO KEEP YOU COOL

Cooling fabric designed with sun protection in mind. Our chemical-free fabric Coolcore® reduces the surface temperature on our cooling shirt up to 30%, so you don't overheat. It carries a 50 Ultraviolet Protection Factor rating, the highest attainable, blocking 98% of harmful UV rays.

## SHORT SLEEVE COOLING SHIRTS

- MEN'S**  
S-3XL | 2860634 | \$34.99
- WOMEN'S**  
S-3XL | 2860636 | \$34.99

# HEATED VEST



## HEATED VESTS

S-3XL | \$199.99

- NEW** WOMEN'S BLACK | 2861440
- NEW** MEN'S BLACK | 2861441

- Replacement / Spare Battery: 2869692
- Replacement Cord: 2869694

# RAIN SUIT



## RAIN JACKET

GRAY

S-3XL | 2869527 | \$99.99

## RAIN PANTS

GRAY

S-3XL | 2869528 | \$84.99

- 100% waterproof lightweight and packable nylon
- YKK® Zippers
- Rain jacket has removable hood



# HELMETS



RED/BLACK  
XS-4XL  
2861470



## [ALTITUDE]



BLACK  
XS-4XL  
2861469



BLACK/RED  
XS-4XL  
2861472



**\$399<sup>95</sup>**  
CARBON FIBER  
BLACK/LIME  
XS-4XL | 2861473

### **NEW** 509<sup>®</sup> ALTITUDE 2.0 HELMET

**\$299<sup>95</sup>**

Lightweight Design, performance-infused style and features with all-day comfort

#### SHELL

- Strong, lightweight construction of carbon fiber or fiber glass

#### WEIGHT

- Composite as low as 1,260g
- Carbon fiber as low as 1,150g

#### FEATURES

- Superior fit for all-day comfort
- Removable Pro Series breath box provides excellent ventilation and air flow
- One-piece eye-port creates draft-free seal with 509<sup>®</sup> goggles
- Magnetic Fidlock<sup>®</sup> chin-strap technology and integrated GoPro<sup>®</sup> mount
- DOT- and ECE 22.05-approved



## [TENACITY]



BLACK  
XS-2XL  
2861557



BLACK/GRAY  
XS-2XL  
2861558



BLACK/WHITE  
XS-2XL  
2861560



WHITE/RED  
XS-2XL  
2861561



PINK  
XS-2XL  
2861562

### **NEW** TENACITY 4.0 HELMET

**\$139<sup>99</sup>**

Combination of modern style and premium protection with incredible value

#### SHELL

- Shock-resistant, injection-molded thermoplastic

#### WEIGHT

- 1,500g

#### FEATURES

- Through-flow, full-helmet ventilation
- ProClip quick release chin strap allows you to fasten the chin strap in seconds
- Removable breath box
- Tool-less adjustable roost shield
- Removable, washable liner
- DOT- and ECE 22.05-approved

# GOGGLES



BLACK  
2868669

RED  
2868670

LIME  
2868671

BLUE  
2868667

### KINGPIN 509<sup>®</sup> DIRT GOGGLE

**\$54<sup>99</sup>**

Premium Materials, attractive price

#### FEATURES

- Oversized spherical lens delivers optimal peripheral vision
- Metal tear off posts provide strength and durability
- Quick-change technology allows you to run the best lens tint for conditions



ORANGE  
2868668

### TRAIL GOGGLE

**\$34<sup>99</sup>**

Clear Vision at a Great Value

#### FEATURES

- Offers a distortion-free view with anti-scratch, anti-fog and UV-blocking technology
- Large lens opening enables greater peripheral vision



BLACK  
2867917



# OUTERWEAR



**FORCE JACKET**

**WINDBREAKER JACKET**

**NEW**  
**FORCE JACKET** **\$139.99**

Versatile, lightweight jacket ideal for layering or wearing as a casual jacket.

MEN'S | S-3XL | 2861432



**WOMEN'S**  
 S-3XL | 2861433

**NEW**  
**WINDBREAKER JACKET** **\$99.99**

Lightweight, windproof jacket that provides protection while riding.

- 100% polyester windproof fabric
- 3 external pockets allow for maximum storage

S-3XL | 2861541



**GRAY/BLUE**  
 S-3XL | 2861439

**BLACK**  
 S-3XL | 2861434

**NEW**  
**SOFTSHELL JACKET** **\$129.99**

Lightweight performance that's surprisingly warm and perfect for everyday wear

- DWR prevents precipitation from saturating the jacket's exterior
- Three external and one internal pocket
- Lined with 280 grams of soft fleece for warmth
- Removable hood and underarm venting

**MAROON**  
 S-3XL | 2861438

**BLACK**  
 S-3XL | 2861437

**GRAY**  
 S-3XL | 2861435

**BLACK/BLUE**  
 S-3XL | 2861436

**WOMEN'S**

**MEN'S**



**FLANNEL JACKET**  
**BRONZE**  
 S-3XL | 2860864

**WORK JACKET**  
**FOREST GREEN**  
 S-3XL | 2860862

**FLANNEL JACKET** **\$99.99**

**CHARCOAL**  
 S-3XL | 2860865

This stylish flannel jacket is designed to keep you riding on brisk days. Soft yet durable brushed flannel with a Sherpa fleece lining offers excellent insulation without the bulkiness of a winter jacket.

**WORK JACKET** **\$159.99**

This warm and rugged jacket was engineered to be tough enough for work yet stylish enough for play.

**External features:**

- Constructed of Nylon 6, a durable, tear-resistant non-stretch woven fabric
- Coated with Durable Water Repellency (DWR) to provide water-resistance in the elements
- Four external pockets for maximum gear storage

**Internal features:**

- 80 gram 3M® Thinsulate® for added warmth
- Built in action back for increased range of motion
- Internal zipper pocket
- Brushed flannel trim

**NEW**  
**BLACK**  
 S-3XL | 2861608

**GRAY**  
 S-3XL | 2860863

# LAYERING



**TECH QUARTER ZIP**  
**PINK**  
 S-3XL | 2861448

**NORTHSTAR MID LAYER**  
**BLACK/GRAY**  
 S-3XL | 2869925

**NEW**  
**TECH QUARTER ZIP** **\$59.99**

Excellent for ride layering, comfortable and stylish stand-alone.

**WOMEN'S**

**MEN'S**



**BLACK**  
 S-3XL | 2861447



**BLUE**  
 S-3XL | 2861443



**BLACK**  
 S-3XL | 2861442



**NEW**  
**BLACK/RED**  
 S-3XL | 2861445

**NORTHSTAR MID LAYER** **\$89.99**

Breathable fleece mid-layer is perfect for adding warmth or as a stand-alone shirt.

APPAREL & HELMETS

OUTERWEAR & PROTECTION

LIFESTYLE & CAPS

CAMO & GIFTS



# LIFESTYLE



**NEW**  
**MEN'S ICON HOODIE**  
 S-3XL | \$54.99  
 BLACK | 2861496  
 GREEN | 2861495



**NEW**  
**WOMEN'S TECH HOODIE**  
 S-3XL | \$64.99  
 GRAY | 2861508  
 MAROON | 2861509

# HATS & T-SHIRTS



**NEW**  
**MEN'S ALL-IN TEE**  
 S-3XL | \$24.99  
 BLACK | 2861574  
 GRAY | 2861575



**NEW**  
**BADGE TRUCKER HAT**  
 One-Size | \$24.99  
 GRAY | 2861531  
 NAVY | 2861532  
 BLACK | 2861533  
 PINK | 2861549  
 MAROON | 2861537



**NEW**  
**TONAL HAT**  
 L/XL | \$24.99  
 BLACK | 2861526  
 NAVY | 2861525



**NEW**  
**CORE HAT**  
 One-Size | \$24.99  
 NAVY | 2861523  
 BLACK | 2861524



**NEW**  
**CHECKERED HAT**  
 One-Size | \$24.99  
 NAVY | 2861520  
 GRAY | 2861521  
 BLACK | 2861522

APPAREL & HELMETS

OUTWEAR & PROTECTION

LIFESTYLE & CAPS

CAMO & GIFTS



**NEW**  
**MEN'S CREW SWEATSHIRT**  
 S-3XL | \$49.99  
 GREEN | 2861498  
 NAVY | 2861497



**NEW**  
**WOMEN'S ICON HOODIE**  
 S-3XL | \$54.99  
 MAROON | 2861507  
 BLACK/PINK | 2861506



**NEW**  
**WOMEN'S ALL-IN TEE**  
 S-3XL | \$24.99  
 BLACK | 2861598  
 OLIVE | 2861599



**NEW**  
**MEN'S PERFORMANCE LONG SLEEVE**  
 S-3XL | \$39.99  
 ROYAL | 2861589  
 GRAY | 2861588



**NEW**  
**MEN'S TECH HOODIE**  
 S-3XL | \$64.99  
 BLACK/BLUE | 2861494  
 GRAY | 2861493



**NEW**  
**WOMEN'S CHECKERED HOODIE**  
 S-3XL | \$39.99  
 BLACK | 2861609  
 BLUE | 2861610



**NEW**  
**MEN'S BACK GRAPHIC TEE**  
 S-3XL | \$24.99  
 GRAY | 2861568  
 NAVY | 2861569



**NEW**  
**MEN'S STAMP TEE**  
 S-3XL | \$24.99  
 GRAY | 2861565  
 GREEN | 2861564



# CAMO

**NEW**

**STEALTH CAMO HAT**  
One-Size | \$24.99  
CAMO | 2861527



**NEW**

**NORTHSTAR MID LAYER**  
S-3XL | \$89.99  
CAMO | 2861542

**NEW**

**CAMO SOFTSHELL JACKET**  
S-3XL | \$129.99  
CAMO | 2861543



**CAMO POLY HOODIE**  
S-3XL | \$54.99  
BLACK | 2860718



**HUNTER CAMO HOODIE**  
S-3XL | \$49.99  
OLIVE | 2868716  
GRAY | 2860728



**CAMO FULL ZIP**  
S-3XL | \$59.99  
OLIVE | 2869590



**MEN'S CAMO TEE**  
S-3XL | \$24.99  
GRAY | 2860709  
BLACK | 2860710



**CAMO HOODIE**  
S-3XL | \$54.99  
WOMEN'S | 2867898  
MEN'S | 2867879



**CAMO TRUCKER HAT**  
One-Size | \$24.99  
BLACK | 2860613  
PINK | 2860614

# GIFTS & BRANDED MERCHANDISE

**POLARIS STEEL SIGN (14" x 36")**  
2860868 | \$129.99

**PINT GLASS (SET OF 2)**  
2860815 | \$19.99

**POLARIS WOODEN COASTERS WITH BOTTLE OPENER**  
2860869 | \$24.99

## DRINKWARE



**PREMIUM COOZIE**  
2860829 | \$7.99



**NEW**  
**17oz WATER BOTTLE**  
2861611 | \$24.99



**NEW**  
**12oz CAMPER MUG**  
2861612 | \$29.99



**NEW**  
**15oz CAMPFIRE MUG**  
2861613 | \$19.99

## RECREATION/GARAGE



**NEW**  
**EVENT FOLDING CHAIR**  
2861617 | \$44.99



**NEW**  
**FOLDING TABLE**  
2861620 | \$49.99



**POLARIS WOOD SIGN (10.5" x 24")**  
2860866 | \$74.99



**NEW**  
**NECK GAITERS**  
One-Size | \$12.99  
CAMO | 2861948  
BLACK | 2861953

## COLLECTIBLES



**NEW**  
**KEYCHAIN**  
2861614 | \$6.99



**NEW**  
**LEATHER KEYCHAIN**  
2861616 | \$6.99



**MINI SPORTSMAN TOY**  
2860821 | \$17.99



**BOTTLE OPENER**  
2860818 | \$14.99



# FORGE YOUR OWN PATH



CONNECT ONLINE  
SEARCH "PolarisORV"



## BUILD YOUR POLARIS SPORTSMAN

VISIT [POLARIS.COM/SPORTSMAN](https://www.polaris.com/sportsman)

TO SEE ALL YOUR OPTIONS & ACCESSORIES ON YOUR NEW MACHINE FROM EVERY ANGLE!

**1** CHOOSE  
MODEL

**2** CHOOSE  
TRIM

**3** CHOOSE  
COLOR

**4** CHOOSE  
ACCESSORIES



WARNING: POLARIS OFF-ROAD VEHICLES CAN BE HAZARDOUS TO OPERATE AND ARE NOT INTENDED FOR ON-ROAD USE. DRIVER MUST BE AT LEAST 16 YEARS OLD WITH A VALID DRIVER'S LICENSE TO OPERATE. ALL RIDERS SHOULD ALWAYS WEAR HELMETS, EYE PROTECTION AND PROTECTIVE CLOTHING AND FOOTWEAR. READ, UNDERSTAND AND FOLLOW YOUR OWNER'S MANUAL. RIDE WITHIN THE LIMITS OF YOUR OWN ABILITIES AND NEVER ENGAGE IN STUNT OR EXHIBITION DRIVING. NEVER RIDE UNDER THE INFLUENCE OF DRUGS OR ALCOHOL. ALL RIDERS SHOULD TAKE A SAFETY TRAINING COURSE. CALL 800-342-3764 FOR ADDITIONAL INFORMATION.

UNLESS NOTED, TRADEMARKS ARE THE PROPERTY OF POLARIS® INDUSTRIES INC. 3M® and Thinsulate® are registered trademarks of 3M Company. 509® is a registered trademark of Teton Outfitters, LLC. Batteryminder® is a registered trademark of VDC Electronics Inc. Bluetooth® is a registered trademark of Bluetooth Sig, Inc. Browning® is a registered trademark of BROWNING INTERNATIONAL S.A.. Caliber® is a registered trademark of Caliber, Inc. CAMSO® is a registered trademark of Artic Investments S.A. CREE® is a registered trademark of Cree, Inc. COOLCORE® is a registered trademark of COOLCORE LLC. Fidlock® is a registered trademark of Fidlock GmbH. FOX® is a registered trademark of Fox Factory Inc. High Lifter® is a registered trademark of High Lifter Products, Inc. Kolpin® is a registered trademark of Polaris Industries, Inc. Mossy Oak® is a registered trademark of Haas Outdoors, Inc. OGIO® is a registered trademark of Ogio International, Inc. Rigid® is a trademark of JST Performance, LLC d/b/a Rigid Industries, LLC. Rockford Fosgate® is a registered trademark of Rockford Corporation. TEKVEST® is a registered trademark of 1181676 ONTARIO INC. Tiger Drylac® is a registered trademark of TIGER COATINGS GMBH & CO. KG. Velcro® is a registered trademark of VELCRO BVDA. Yeti® is a registered trademark of Yeti Coolers, LLC. YKK® is a registered trademark of YKK Corporation. YouTube® is a registered trademark of Google Inc. PRICES, FITMENT AND AVAILABILITY ARE SUBJECT TO CHANGE AT ANY MOMENT. COPYRIGHT © 2020 POLARIS INDUSTRIES INC. ALL RIGHTS RESERVED.

# POLARIS

MY21 SPTSMN APP ACC US • 9948053