



 POLARIS®
SPORTSMAN®

2018

ACCESSORIES + APPAREL



 POLARIS®
ACE®

GET ON SOME OFF-ROAD

The Polaris® Sportsman® is engineered to be the hardest-working, smoothest-riding ATV available.



POLARIS SPORTSMAN®

RECREATION/UTILITY



SPORTSMAN® 450 H.O. (EPS)
33HP



SPORTSMAN® 570 SP
44HP



SPORTSMAN® 570 (EPS) UTILITY ED.
44HP



SPORTSMAN® 450 H.O. UTILITY ED.
33HP



SPORTSMAN® 570 (EPS)
44HP



SPORTSMAN® 850
78HP

SPORT/UTILITY



SPORTSMAN® 850 SP
78HP



SPORTSMAN XP® 1000
90HP

2-UP & UTILITY



SPORTSMAN® X2 570 EPS
44HP



SPORTSMAN® TOURING 850 SP
78HP



SPORTSMAN® TOURING 570 (EPS)
44HP



SPORTSMAN® TOURING XP 1000
88HP



SPORTSMAN® TOURING 570 SP
44HP



SPORTSMAN® BIG BOSS® 6X6 570 EPS
44HP

SPORT & MUD



SCRAMBLER® 850
78HP



SPORTSMAN® 850 HIGH LIFTER EDITION
78HP



SCRAMBLER® XP 1000
89HP



SPORTSMAN XP® 1000 HIGH LIFTER EDITION
85HP

POLARIS ACE®



SINGLE-SEAT FREEDOM.

For a new kind of off-road adventure, Polaris ACE® combines the performance of Polaris® with the confidence of a centered driving experience.



POLARIS ACE® 500
32HP



POLARIS ACE® 900 XC
78HP



POLARIS ACE® 570 EPS
45HP



POLARIS ACE® 150 EFI 
15HP

SPORTSMAN®

POLARIS ENGINEERED ACCESSORIES™	02	450/570	10
TRAIL	04	XP TOURING	12
BUMPERS	06	HUNT	14
XP 1000	08	BIG BOSS®/SCRAMBLER®	16

COMMON ITEMS

POLARIS NORTHSTAR® COOLERS	18
WINCH/PLOW	20
WHEELS/TIRES	26

COMMON ITEMS

TRACKS/TECHNOLOGY	32
LIGHTING	34
AUDIO	36
ESSENTIALS	38

OIL/LUBRICANTS	48
GARAGE	50
APPAREL	58

POLARIS ACE®

POLARIS ACE® 900	40
POLARIS ACE® 570/150	42
BUMPERS & GUARDS	44
CAB SYSTEM	46

DESIGNED FOR YOU ENGINEERED TOUGH

POLARIS®
ENGINEERED PARTS
ACCESSORIES & APPAREL

Ensuring Polaris Engineered Accessories™ fit and work in sync with your machine is the most critical phase of testing and validation. With seamless integration, you can trust that any Polaris® accessory you install will enhance your interaction beyond your expectations.

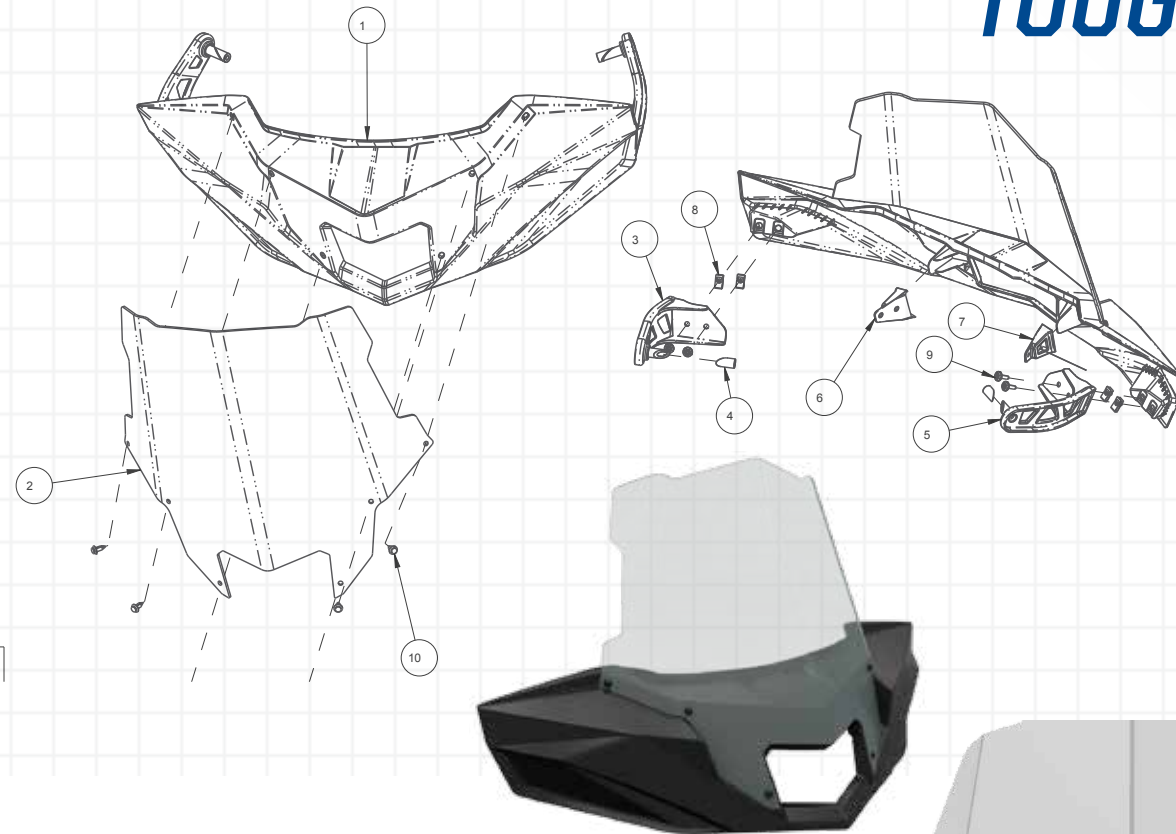

DESIGNED

Only Polaris Engineered Accessories™ are conceived, designed and fabricated in lockstep with the Polaris SPORTSMAN development process. As the vehicle progresses from concept to production, so do the accessories. This ensures perfect fit and optimal performance.

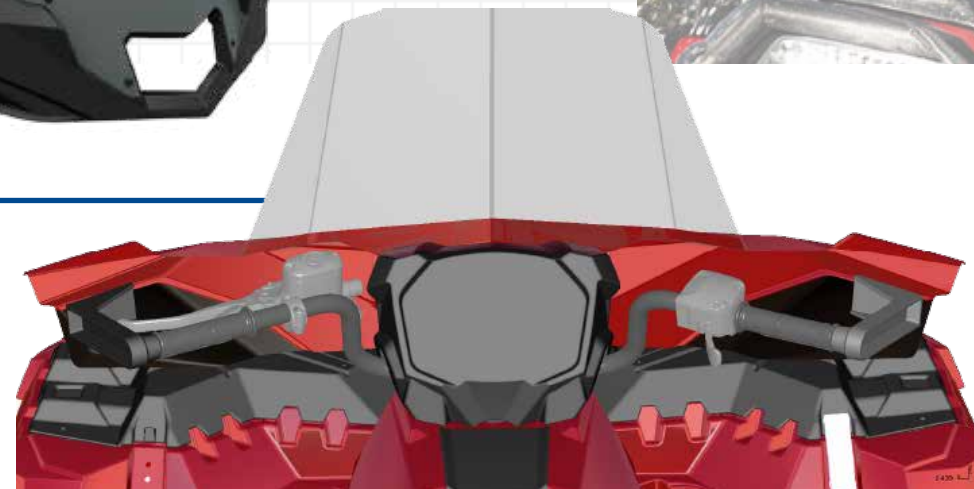

TESTED

The Polaris® testing process is rigorous and unforgiving. We put both vehicle and accessory through extreme use conditions both in the lab and in the field - in all environments, and in locations spanning the continent. If it doesn't pass our standards, it's not ready for your Polaris® vehicle. This means only the best make it to production.

TRUSTED

Developing the best, most premium accessories in the industry is our passion. Only Polaris® can combine decades of industry-leading experience, innovation, and off-road expertise. You can have confidence in your Polaris Engineered Accessories™, because we know the lifestyle and live it everyday.

POLARIS® PARTNERS WITH THE BEST

We choose our partners carefully, selecting only the best in off-road. Every accessory is rigorously tested and validated at Polaris® standards, to ensure seamless integration and performance.



KOLPIN
OUTDOORS
HUNTING ACCESSORIES p.14



WHEELS & TIRES p.20
LIGHTING SOLUTIONS p.34

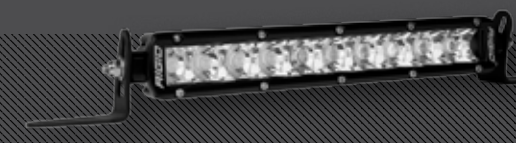

RIGID
LIGHTING SOLUTIONS p.34



MBQUARTI
AUDIO COMPONENTS p.36

THE ULTIMATE ATV



POLARIS® SPORTSMAN XP® 1000
HAVASU RED PEARL

No matter where the trail takes you, you can rely on your legendary Sportsman XP® 1000, 850, & 850 SP and the new line of Polaris Engineered Ultimate Series Accessories™ to help you own your day off-road. Add everything from brushguards and lighting to windshields and storage racks to ensure you're equipped for the ultimate off-road ride.



A. WINDSHIELD FAIRING • 2882512

WINDSHIELD (MID) • 2882151

B. RACK EXTENDER 10 cm

(FRONT & REAR) • 2882022 & 2882023

C. FRONT BUMPER • 2882020

D. RIGID® 30 cm SR-SERIES

COMBO LIGHT BAR • 2883123

LED LIGHT BAR HARNESS • 2882320

E. POLARIS® PRO HD 1588 kg (3500 lb) WINCH • 2880435

F. BODY ARMOR • 2882090

G. POLARIS NORTHSTAR® COOLER - 28 L • 2881315

H. POLARIS® RATCHET TIE-DOWN STRAPS BLACK • 2859047-02

I. PRO ARMOR® WHEEL & TIRE SET:

SIXR MATTE BLACK & ATTACK • 2881360

J. LOCK & RIDE® REAR CARGO BOX • 2882882

K. REAR BUMPER • 2882583

L. REAR CARGO HOLD BAG • 2882303

ALL-TERRAIN SAFEGUARDS

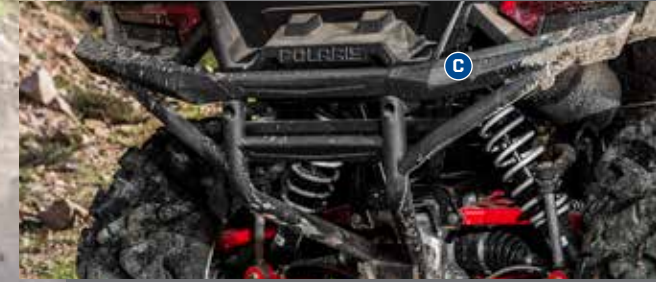

- A SPORTSMAN® ULTIMATE SERIES -FRONT BUMPER**
 - Quick installation to the integrated mounting tubes on the vehicle using wedge-style expansion anchor mounts
 - Attach the all-new Body Armor to the front bumper to provide the ultimate protection package for the front fenders

» 2882020
XP 1000 '17-18, 850/850 SP '17-18
- B SPORTSMAN® ULTIMATE SERIES -BODY ARMOR**
 - Securely mounts to new Sportsman XP® Front Bumper (2882020)

» 2882090
XP 1000 '17-18, 850/850 SP '17-18
- C SPORTSMAN® ULTIMATE SERIES -REAR BUMPER**
 - » 2882583
XP 1000 '17-18, 850/850 SP '17-18

SPORTSMAN® 570 / 450 H.O. BRUSHGUARD TOP SELLER



• Durable black powdercoating for long-lasting, scratch-resistant finish

FRONT BRUSHGUARD

» 2879714
X2 570 '15-18, TOURING 570 SP '15-18, TOURING 570 '14-18, ETX '15-16, 570 SP '15-18, 570 '14-18, 570 6X6 '17-18, 450 H.O. '16-18

REAR BRUSHGUARD

» 2879715
TOURING 570 SP '15-18, TOURING 570 '14-18, ETX '15-16, 570 SP '15-18, 570 '14-18, 450 H.O. '16-18

SPORTSMAN XP® BRUSHGUARD



• Integrated mounting location for easy installation and accessory lighting

FRONT BRUSHGUARD

» 2878709
XP 1000 '15-16, X2 850 '11-12, X2 550 '10-14, TOURING XP 1000 '15-17, TOURING 850 SP '15-17, TOURING 850 '10-14, TOURING 550 '10-14, 850/XP1000 '16-17, 850/850 SP '09-16, 550 '09-14

REAR BRUSHGUARD

» 2878710
XP 1000 '15-16, 850/XP 1000 '16-17, 850/850 SP '09-16, 550 '09-14

SPORTSMAN® DELUXE BRUSHGUARD



FRONT BRUSHGUARD

» 2878669
TOURING 500 '13, 800 '12-14, 800 6X6 '12-14, 500 '12-14, 500 H.O. '12-13, 400 H.O. '12-14

REAR BRUSHGUARD

» 2878670
800 '12-14, 500 '12-14, 500 H.O. '12-13, 400 H.O. '12-14



EXPANSION WEDGE ANCHORS

Ultimate Series front and rear bumpers attach quickly and easily thanks to expansion wedge anchors. Since they fit into the integrated mounting points found on your Sportsman XP® 1000 or 850, there is no need to drill holes into the vehicle's frame.



FARM & RANCH FRONT BUMPER NEW

• Includes front receiver for additional functionality

» 2882301
ETX '15, 570 '14-17, 450 H.O. '16-18



SPORTSMAN® TOURING REAR BRUSHGUARD

• Adds heavy-duty rear protection and a custom look

» 2878324
TOURING XP 1000 '15-18, TOURING 850 SP '15-18, TOURING 850 '10-14, TOURING 550 '10-14



SPORTSMAN® X2® REAR BUMPER

• Distinctive off-road styling for customization

• Provides additional protection from trail hazards

• Designed specifically for the Sportsman X2®

» 2877686
X2 850 '11-12, X2 550 '10-14, 570SP X2 -'17, 850SP X2 -'17

SPORTSMAN® ULTIMATE SERIES

The ultimate rec / utility ATVs deserve the ultimate line of accessories. Equip your Sportsman XP® 1000 or 850 with our line of Ultimate Accessories and enjoy all-day comfort. Add a windshield to cut the bitterly cold wind, keep your hands warm with a simple-to-install hand warmer kit, prevent items from sliding off your racks with an extension kit, or simply add more storage.

SPORTSMAN® ULTIMATE SERIES WINDSHIELDS

WINDSHIELD FAIRING

- Customizable system based on your style and protection needs
- All-new fairing is the base for the best wind protection system to date

» 2882512
XP 1000 '17-18, 850/850 SP '17-18

WINDSHIELD FAIRING BAG

» 2882454
XP 1000 '17-18, 850/850 SP '17-18



TALL VIEW

» 2882152
XP 1000 '17-18, 850/850 SP '17-18

TALL VIEW HARD COAT

» 2881161
XP 1000 '17-18, 850/850 SP '17-18

MID VIEW

» 2882151
XP 1000 '17-18, 850/850 SP '17-18

LOW VIEW

» 2882150
XP 1000 '17-18, 850/850 SP '17-18

HARD COAT

Give your impact-resistant poly windshield extra defense. Hard coat is 30x more scratch-resistant, meaning you'll be able to handle whatever gets thrown at you.

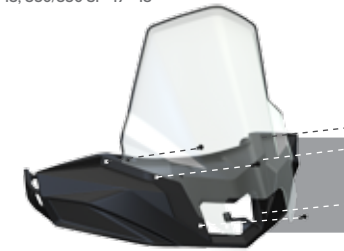
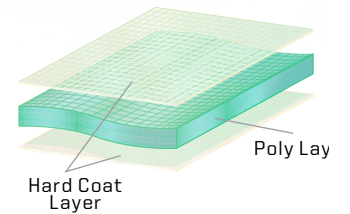

EASY TO CHANGE WINDSHIELDS
WITH 6-DART INSTALL

Our fairing system allows for changing out the windshield quickly and easily. Simply remove the six dart-type fasteners and swap out the windshield.

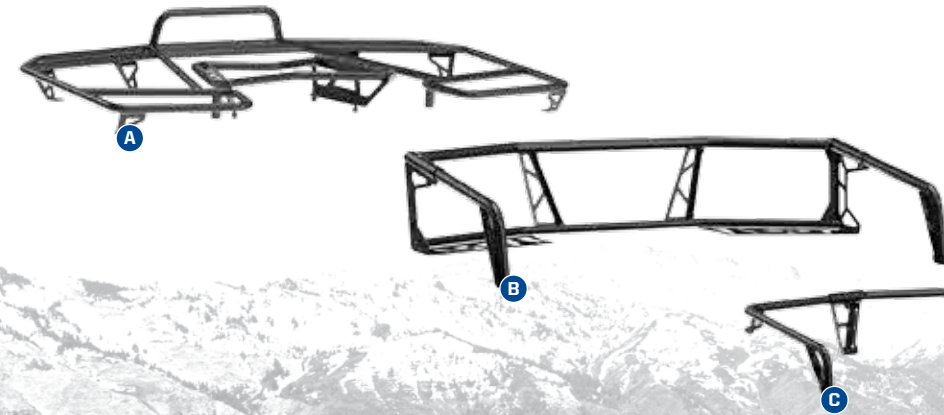

- | | | | |
|--|---|--|--|
| A | B | C | D |
| SPORTSMAN® STEEL RACK <i>NEW</i> | ULTIMATE SERIES RACK EXTENDER 10 cm | ULTIMATE SERIES RACK EXTENDER 18 cm | MOVEABLE TIE-DOWN POINTS |
| REAR | REAR | REAR | FRONT / REAR |
| » 2883258
XP 1000 '17-18, 850/850 SP '17-18 | » 2882025
XP 1000 '17-18, 850/850 SP '17-18
Does not fit with [2882882] | » 2882023
XP 1000 '17-18, 850/850 SP '17-18
Fits with Rear Cargo Box [2882882] | » 2882270 (SOLD IN PAIRS)
XP 1000 '17-18, 850/850 SP '17-18 |

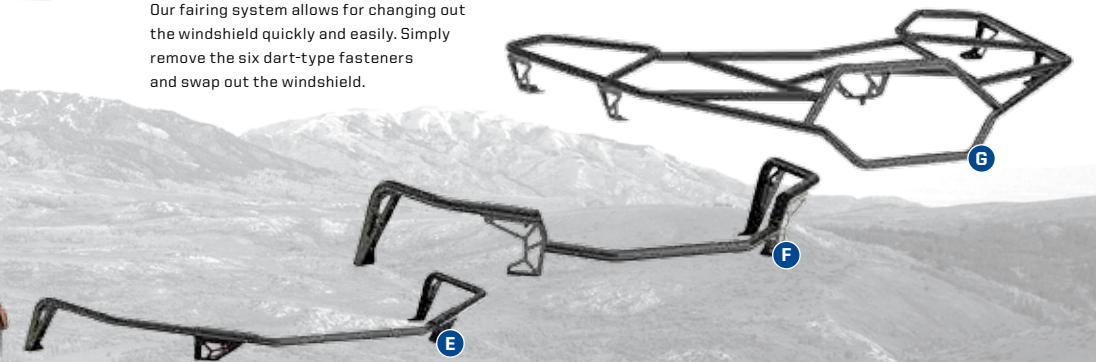

- | | | |
|--|--|---|
| E | F | G |
| ULTIMATE SERIES RACK EXTENDER 18 cm | ULTIMATE SERIES RACK EXTENDER 10 cm | SPORTSMAN® STEEL RACK <i>NEW</i> |
| FRONT | FRONT | FRONT |
| » 2882024
XP 1000 '17-18, 850/850 SP '17-18 | » 2882022
XP 1000 '17-18, 850/850 SP '17-18 | » 2883257
XP 1000 '17, 850/850 SP '17-18 |



LOCK & RIDE SPORTSMAN® ULTIMATE SERIES REAR CARGO BOX

- Increase your ATV storage with an extra 95 L of capacity
 - Store two full-size helmets.
- » 2882882
XP 1000 '17-18, 850/850 SP '17-18, ETX '15, 570 SP '15-18, 570 '14-18, 450 H.O. '16-18



SPORTSMAN® ULTIMATE SERIES REAR CARGO HOLD BAG

- Upgrade your stock rear storage component with this removable, divided storage bag
- » 2882303
XP 1000 '17-18, 850/850 SP '17-18

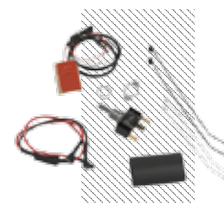

THROTTLE/THUMB WARMERS

» 2877364
ALL SPORTSMAN MODELS



HANDLEBAR HAND WARMERS

» 2877363
ALL SPORTSMAN® MODELS



ULTIMATE SERIES - READYPACK

- Keep your trail essentials at the ready with this easy-to-access, weather-resistant storage compartment
- » 2882271
XP 1000 '17-18, 850/850 SP '17-18



LOCK & RIDE FRONT CARGO BOX

- Replaces stock rack, adds convenient storage location
- » 2877951
XP 1000 '15-16, TOURING XP 1000 '15-18, TOURING 850 SP '15-18, TOURING 850 '10-14, TOURING 550 '10-14, 850/850 SP '09-16, 550 '09-14

SPORTSMAN® 450/570 SERIES

Hardworking and smooth riding combine to give you the legendary Polaris Sportsman® ATV. On your land, on the farm, or at the job site, Sportsman® has accessories to make your day more comfortable and convenient.

SPORTSMAN® LOCK & RIDE® POLY WINDSHIELDS



LOCK & RIDE SPORTSMAN® WINDSHIELDS

SIZE	COLOR	PART #	PRICE	SIZE	COLOR	PART #	PRICE
TALL 19.25" (48.9 CM)	CLEAR	2878389		TALL 19.25" (48.9 CM)	CLEAR	2880539-409	
MID 15.5" (39.4 CM)	BLACK	2878388-070		MID 15.5" (39.4 CM)	BLACK	2880540-070	
MID 15.5" (39.4 CM)	SMOKE	2878388		MID 15.5" (39.4 CM)	SMOKE	2880540-412	
LOW 9.5" (24.1 CM)	BLACK	2878387		LOW 9.5" (24.1 CM)	BLACK	2880541-070	

X2 570 '15-17, TOURING 570 '14-17, TOURING 500 '13, ETX '15, 800 6X6 '12-14, 800 '12-14, 570 '14-17, 500 H.O. '12-13, 500 '12-14, 450 H.O. '16-17, 400 H.O. '12-14

XP 1000 '15-16, TOURING XP 1000 '15-18, TOURING 850 SP '15-18, TOURING 570 SP '15-17, 850/850 SP '09-16, 570 SP '15-18, 570 '18, 570 6X6 '17-18, 450 H.O. '18



HANDGUARDS

COLORS

■ BLACK	2876846
□ BRIGHT WHITE	2876883
■ INDY RED	2876845

ALL SPORTSMAN® MODELS

HANDGUARD MOUNT

• This handguard mount is required when installing Polaris® Handguards

» 2879380

ALL SPORTSMAN®



A SPORTSMAN® 570/450 H.O. STEEL RACK

REAR

» 2882322

ETX '15, 570 SP '15-17, 570 '14-17, 450 H.O. '16-18

B SPORTSMAN® 570/450 H.O. RACK EXTENDERS TOP SELLER

REAR

» 2879717

TOURING 570 SP '15-18, TOURING 570 '14-18, ETX '15, 570 SP '15-18, 570 '14-18, 450 H.O. '16-18

C LOCK & RIDE SPORTSMAN® BACKREST

REAR

» 2879887

ETX '15, 570 SP '15-17, 570 '14-17, 450 H.O. '16-18
Does not fit with K-CARGO BOX, REAR, LOCK&RIDE® (2875176)

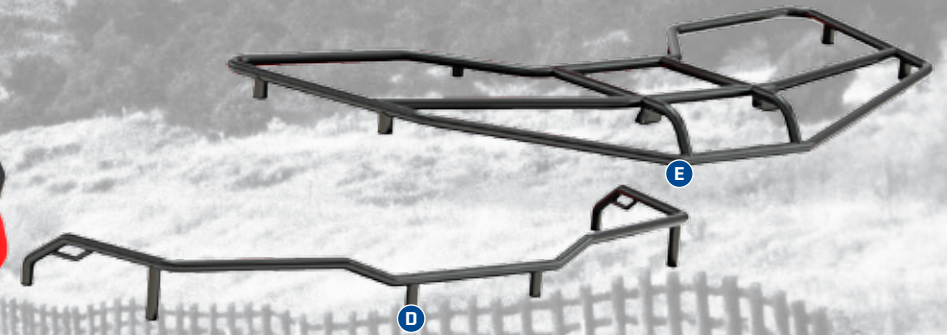

D SPORTSMAN® 570/450 H.O. RACK EXTENDERS TOP SELLER

FRONT

» 2879716

X2 570 '15-18, TOURING 570 SP '15-18, TOURING 570 '14-18, ETX '15, 570 SP '15-18, 570 '14-18, 570 6X6 '17-18, 450 H.O. '16-18

E SPORTSMAN® 570/450 H.O. STEEL RACK

FRONT

» 2882321

X2 570 '15-18, TOURING 570 '14-18, 570 SP '15-18, 570 '14-18, 570 6X6 '17-18, ETX '15, 450 H.O. '16-18



LOCK & RIDE XL STORAGE BOX

» 2881128-070

XP 1000 '15-18, X2 570 '15-18, TOURING XP 1000 '15, ETX '15, 850/XP 1000 '16-17, 850/850 SP '09-18, 800 '12-14, 570 SP '15-18, 570 '14-18, 570 6X6 '17-18, 550 '09-14, 500 '12-14, 500 H.O. '12-13, 450 H.O. '16-18, 400 H.O. '12-14

While the XL Storage Box comes with two dividers and can be used as is, it really serves its purpose when combined with up to three of our XL Bags. The bags are designed to serve a specific need and can be easily removed for portability.

LOCK & RIDE XL STORAGE BOX MOUNT

• Includes mount kit and tie down straps
• Tie-down straps are required for added cargo security

» 2881331

XP 1000 '15-18, X2 570 '15-18, ETX '15-16, 850/XP 1000 '16-17, 850/850 SP '09-18, 800 '12-14, 570 SP '15-18, 570 '14-18, 570 6X6 '17-18, 550 '09-14, 500 '12-14, 500 H.O. '12-13, 450 H.O. '16-18, 400 H.O. '12-14



A. XL SOFT SIDE COOLER

» 2881428



B. XL TRAIL BAG

» 2881130



C. XL TOOL BAG

» 2881129



XL POLARIS PURSUIT CAMO RANGE BAG

» 2881131

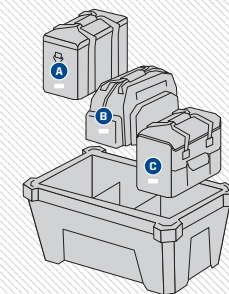

LOCK & RIDE SPORTSMAN® ULTIMATE SERIES REAR CARGO BOX

• Increase your ATV storage with an extra 25 gallons of capacity
• Store two full-size helmets.

» 2882882

XP 1000 '17-18, 850/850 SP '17-18, ETX '15, 570 SP '15-18, 570 '14-18, 450 H.O. '16-18



FENDER BAG

• Easy to access while seated
• Pockets hold water bottles

» 2876604

ALL SPORTSMAN® MODELS
Bag does not work with the Front Storage Box (2877951)

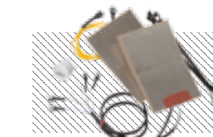

HANDLEBAR HAND WARMERS

» 2877363

ALL SPORTSMAN® MODELS

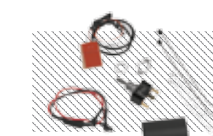

THROTTLE/THUMB WARMERS

» 2877364

ALL SPORTSMAN® MODELS

SPORTSMAN XP® TOURING

When you are enjoying the trails on your Sportsman® Touring XP 1000, you need a line of accessories that won't get in the way of your passenger's experience. All Sportsman XP® Touring accessories are designed specifically to enhance the 2-up experience.

SPORTSMAN® LOCK & RIDE® POLY WINDSHIELDS



Mid 15.5" (39.4 cm) Black



Low 9.5" (24.1 cm) Black

Poly windshields are flexible, **IMPACT RESISTANT**, and provide long-term value over the life of your machine.

LOCK & RIDE SPORTSMAN® WINDSHIELDS

COLOR	SIZE	
CLEAR	TALL 19.25" (48.9 CM)	2880539-409 »
BLACK	MID 15.5" (39.4 CM)	2880540-070 »
SMOKE	MID 15.5" (39.4 CM)	2880540-412 »
BLACK	LOW 9.5" (24.1 CM)	2880541-070 »

XP 1000 '15-16, TOURING XP 1000 '15-18, TOURING 850 SP '15-18, TOURING 570 SP '15-17, 850/850 SP '09-16, 570 SP '15-18, 570 '18, 570 6X6 '17-18, 450 H.O. '18

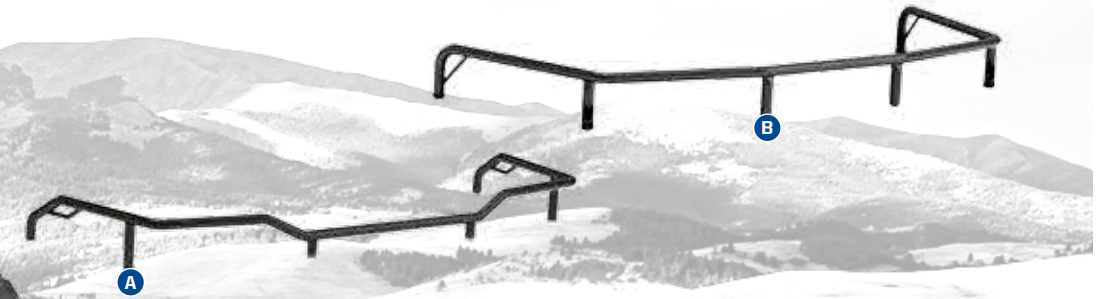

A XP RACK EXTENDER

FRONT

» 2879890

XP 1000 '15-16, X2 850 '11-12, X2 550 '10-14, TOURING XP 1000 '15-18, TOURING 850 SP '15-18, TOURING 850 '10-14, TOURING 550 '10-14, 850/850 SP '09-16, 550 '09-14

B SPORTSMAN® RACK EXTENDER

FRONT

» 2878671

TOURING 500 '13, 800 6X6 '12-14, 800 '12-14, 500 H.O. '12-13, 500 '12-14, 400 H.O. '12-14



SEMI-RIGID TOURING CARGO BAG

- Large-capacity, heavy-duty vinyl bag
- Three zippered openings, removable dividers
- Attaches to rack with Velcro® straps

» 2877220

TOURING 570 '14-18, TOURING 500 '13, 500 H.O. '12



LOCK & RIDE REAR STORAGE BOXES

- Made of heavy-duty polyethylene (Sold in pairs)

» 2878000

TOURING XP 1000 '15-18, TOURING 850 SP '15-18, TOURING 850 '10-14, TOURING 550 '10-14

Slight interference with Sportsman® Touring 550/850 '11-14 passenger handles



LOCK & RIDE FRONT CARGO BOX

- Replaces stock rack, adds convenient storage location

» 2877951

XP 1000 '15-16, TOURING XP 1000 '15-18, TOURING 850 SP '15-18, TOURING 850 '10-14, TOURING 550 '10-14, 850/850 SP '09-16, 550 '09-14

The Front Rack Extender cannot be installed at the same time as the storage box



FENDER BAG

- Perfect place to store gear and snacks
- Easy to access while seated

» 2876604

ALL SPORTSMAN® MODELS

Bag does not work with the Front Storage Box (2877951)

LEGACY ACCESSORIES

SPORTSMAN® RACK EXTENDER

REAR

» 2879891

XP 1000 '15-16, 850/XP 1000 HL '16-18, 850/850 SP '09-16, 550 '09-14

SPORTSMAN® RACK EXTENDER

REAR

» 2878672

800 '12-14, 500 H.O. '12-13, 500 '12-14, 400 H.O. '12-14

SPORTSMAN® RACK EXTENDER

FRONT

» 2878671

TOURING 500 '13, 800 6X6 '12-14, 800 '13-14, 500 H.O. '13, 500 '13-14, 400 H.O. '13-14

SPORTSMAN XP® RACK EXTENDER

FRONT

» 2879890

XP 1000 '15-16, X2 850 '11-12, X2 550 '10-14, TOURING XP 1000 '15-18, TOURING 850 SP '15-18, TOURING 850 '10-14, TOURING 550 '10-14, 850/850 SP '09-16, 550 '09-14

Does not fit vehicles with Front Cargo Box (2877951)

LOCK & RIDE BACKREST

- Fully adjustable for optimal comfort

• 18 CM

» 2876616

XP 1000 '15-16, 850/850 SP '09-16, 550 '09-14
Does not fit with Lock & Ride® Cargo Box (2876601) installed

HANDLEBAR HAND WARMERS

- Keep both hands warm while riding

• Complete kit includes all wiring

» 2877363

ALL SPORTSMAN® MODELS

THROTTLE/THUMB WARMERS

- Keeps throttle thumb warm

• Complete kit includes all wiring

» 2877364

ALL SPORTSMAN® MODELS

HANDLEBAR-MOUNTED MIRROR

- For added safety on or off the trail

» 2877222

ALL SPORTSMAN® MODELS

BE THE APEX PREDATOR



LOCK & RIDE® GUN BOOT® MOUNTS

- High-impact case secures firearm over any terrain
- Lock & Ride® system mounts on right side
- Works with Lock & Ride® XL Storage Box, Lock & Ride® Rear Cargo Box, and Rear Rack Extenders

» 2877381 XP 1000 '15-16, 850/ XP 1000 '16-18, 850/850 SP '09-16, 550 '09-14	» 2879888 ETX '15-16, 570 SP '15-18, 570 '14-18, 450 H.O. '16-18	» 2875783 X2 850 '11-12, X2 550 '10-14
» 2878001 TOURING XP 1000 '15-18, TOURING 850 SP '15-18, TOURING 850 '10-14, TOURING 550 '10-14	» 2881143 POLARIS ACE® '14-16, POLARIS ACE® 900 SP '16, POLARIS ACE® 570 SP '16-17, POLARIS ACE® 570 '15-18, POLARIS ACE® 500 '17-18	

POLARIS® GUN BOOTS BY KOLPIN®

- » BLACK • 2872677
- » MOSSY OAK® BREAK-UP® • 2872677-419



KOLPIN STRONGHOLD® SYSTEM

Polaris® is proud to partner with Kolpin® Outdoors, an industry leader in off-road accessories and the premier name in gun boots and mounts. If you need to secure a firearm, fishing rod, or ice auger while riding, simply attach the auto-latch mount and choose your case.

KOLPIN STRONGHOLD® PRODUCTS SECURELY PROTECT THE ESSENTIALS WHEN ON THE TRAIL.



Check out p.10 for the LOCK & RIDE® XL STORAGE BOX and more storage options for your Sportsman XP® 1000 or 850



XL POLARIS PURSUIT® CAMO RANGE BAG

- » 2881131
ALL SPORTSMAN®



RATCHETING RHINO GRIP® BY KOLPIN®

- Requires minimal rack space and attaches using Lock & Ride® technology

- » 2881157
ALL SPORTSMAN®



RHINO GRIP XL BY KOLPIN®

- » 2881513
ALL SPORTSMAN®



RUBBER STRAPS BY KOLPIN®

- » 2881621
ALL SPORTSMAN®

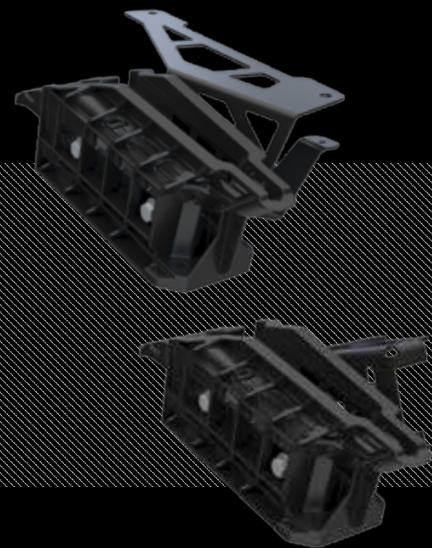

AUTO-LATCH MOUNT **NEW**

- Precision angle adjustable for a custom fit
- Provides a quick and secure attachment point

- » 2882300
ETX '15, 570 SP '15-18, 570 '14-18, 450 H.O. '16-18
- » 2882272
XP 1000 '17-18, 850/850 SP '17-18



GUN BOOT® XL TRANSPORT

- » 2882430
Requires Auto-Latch Mount (2882272 or 2882300)

GUN BOOT® L

- » 2882426
Requires Auto-Latch Mount (2882272 or 2882300)

PISTOL BOOT

- » 2882429
Requires Auto-Latch Mount (2882272 or 2882300)



ICE ROD BOOT

- » 2882428
Requires Auto-Latch Mount (2882272 or 2882300)

ICE AUGER BOOT

- » 2882427
Requires Auto-Latch Mount (2882272 or 2882300)

SPORTSMAN® BIG BOSS® 6X6



"Never transport a loaded firearm. Verify firearm is unloaded prior to mounting. Please refer to local laws and regulations regarding the requirements for the legal transport of firearms."

POLARIS® SCRAMBLER®

Power, performance, and handling distinguish this unique ATV from the competition. Make sure to make it your own with accessories designed specifically for this hardworking sport performer.



A OGIO® SCRAMBLER® BAG

» 2879925
SCRAMBLER® '13-18

B LARGE REAR RACK

» 2879139
SCRAMBLER® '13-18
Not compatible with Ogio® Scrambler® Bag (2879925)

C REAR BASH GUARD

» 2879138
SCRAMBLER® '13-18

D HANDGUARDS

» 2876846 • BLACK
SCRAMBLER® '13-18

E POLARIS® HD 2500 LB (1134 KG) WINCH

» 2880433
SCRAMBLER® '13-18

POLARIS® HD 3500 LB (1588 KG) WINCH

» 2880435 (NOT SHOWN)

WINCH WIRING HARNESS

» 2879919
SCRAMBLER® XP 1000 '14-17,
SCRAMBLER® 850 '13-17,
Required to install Polaris® HD Winches

F HANDLEBAR HEADLIGHT

» 2879245
SCRAMBLER® '13-18

G BRUSHGUARD

» 2879136
SCRAMBLER® '13-18

H PRO ARMOR® WHEEL & TIRE SET: REBLR & ATTACK

» 2881381

I 10MM X 1.25 HEX LUG NUTS (16 PACK)

» 2877384

I FORGED BEADLOCK RINGS

» 14" V00D00 BLUE • 1522244-619

Sold individually. See other forged beadlock rings on pg. 30.

SPORTSMAN® BIG BOSS® 6X6 ACCESSORIES

A LOCK & RIDE YUKON ADVENTURE RACK

• Adds increased storage volume by allowing you to increase storage height securely

» 2882084
570 6X6 '17-18

LOCK & RIDE CARGO BOX ADAPTOR KIT

• Required to add the Sportsman® Cargo Box (2875176) onto the '17-18 Sportsman® Big Boss® 6x6

» 2882302
570 6X6 '17-18
Requires (2875176)

LOCK & RIDE GUN BOOT® MOUNT ADAPTOR KIT

• Utilize this adapter kit to add the Lock & Ride® Gun Boot® Mount (2879888) onto the '17-18 Sportsman® Big Boss® 6x6

» 2882257
570 6X6 '17-18

PROSPECTOR PRO® TRACK SYSTEM

• Delivers true 3-season performance with more flotation and less maintenance

• Rubber pivot system allows rear axles to move independently for maximum traction

• Includes Track Mount & Track Kit

» 2882169
570 6X6 '17-18



GLACIER PRO HD
PLOW SYSTEM
Page 24 for Plow Systems



PROSPECTOR PRO® TRACKS
Page 32



PRO ARMOR® WHEELS & TIRES
Page 26

KEEP IT ICE COLD



Polaris Northstar® Coolers can survive just about anything - from extreme heat to a nasty tumble off a vehicle. So when we say ice will stay cold for hours on end and anything inside will stay locked up tight, we mean it.

POLARIS NORTHSTAR® COOLER

- 99 LITER
» **NEW** GRAPHITE • 2883426
- 57 LITER
» **NEW** GRAPHITE • 2883425
- 28 LITER
» **NEW** GRAPHITE • 2883424
- 19 LITER
» **NEW** GRAPHITE • 2883390
- TUMBLERS **NEW**
» 887 ml • 2883394
- » 591 ml • 2883393
- » DESERT • 2883392
- » DESERT • 2881259
- » DESERT • 2881315

28, 57, 99 LITER FEATURES



ComfortCarry Handles



TravelLock System



EasyOut Drain System



NoSlip Rubber Feet



PolarWall Insulation



IceLock Seal

POLARIS NORTHSTAR® COOLER ACCESSORIES



WIRE BASKET

- » 57 LITER • 2882185 • **SHOW**
- » 28 LITER • 2882438



DIVIDERS

- » 57 LITER • 2882184
COMES WITH ONE DIVIDER
- » 28 LITER • 2882186
COMES WITH ONE DIVIDER

Divider doubles as a cutting board

57 LITER



2 ways to partition

28 LITER



1 way to partition



SEAT CUSHION

- » 57 LITER • 2882179
- » 28 LITER • 2882507

COOLER WHEELS

- » 2882180
57 LITER ONLY



BOTTLE OPENER

- » 2882183
ALL COOLERS

LOCK & RIDE QUICKSTRAP

- » 2882187
ALL COOLERS, RANGER® AND POLARIS GENERAL CARGO BOXES



TIE-DOWN STRAPS

- » 2859047-01 • RED
ALL COOLERS
- » 2859047-02 • BLACK
ALL COOLERS

GRIZZLY TESTED. POLARIS® APPROVED.

This cooler is IGBC-approved, meaning it withstands the power expended by a typical grizzly bear if it was trying to get inside. Seriously, there are experts who know what a grizzly is capable of doing, and they certify that the Polaris Northstar® Cooler can take it.



SUPERIOR

INTEGRATION

Right from the factory, your vehicle is built to make essential accessories like winches and plows quick and simple to install and use regularly. Mounting brackets are designed into the chassis and wiring is routed securely and properly. Perfect fit, perfect integration.

GLACIER^{PRO} HD
PLOW SYSTEM

**DEPENDABLE. TOUGH.
BUILT FOR THE OFF-ROAD.**



✓ Tested **1,200+** pulls at max load, it works when you need it to



✓ Built to withstand **-29° C** temperatures



✓ Sealed motor & heavy duty gears **OPERATE FULLY SUBMERGED UNDERWATER**



✓ **MILITARY** tested & approved

PRE-WIRED CHASSIS

Handlebar controls and wiring are installed at the factory. Mount the winch, connect the wires and trust that everything is routed safely, securely, and properly.

NO NEED TO CUT PANELS

FULLY INTEGRATED MOUNT & WIRING

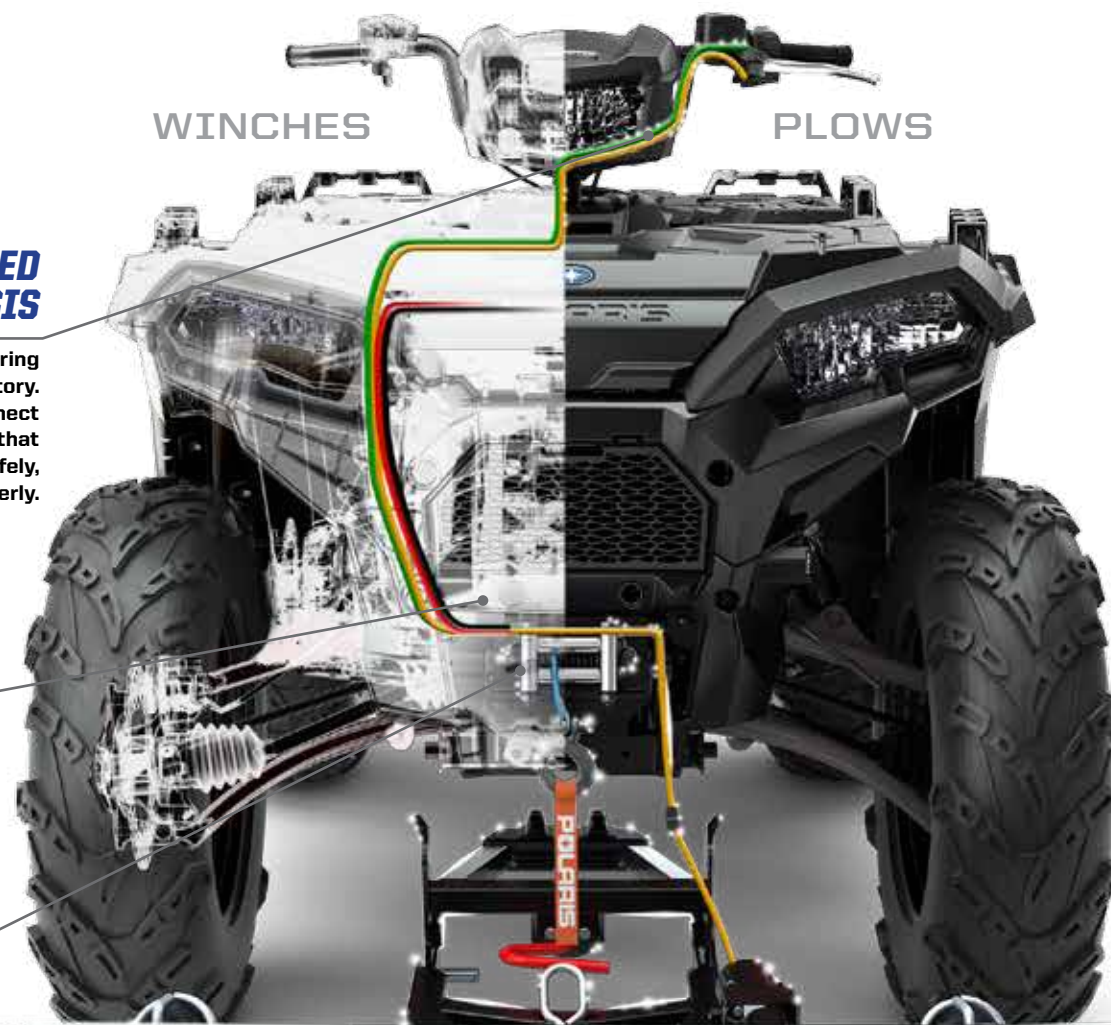

GLACIER[®] vs. COMPETITION



WARN[®]



MOOSE UTILITY DIVISION[®]



SUPERATV

- ✓ To install the plow, simply lift the mount lock handle and pull forward.
- ✓ No loss of factory ground clearance when not plowing.
- ✓ Don't have to crawl under the machine to release the plow blade from the vehicle.
- ✓ No trimming of vehicle plastic or fascia required to mount plow or winch.

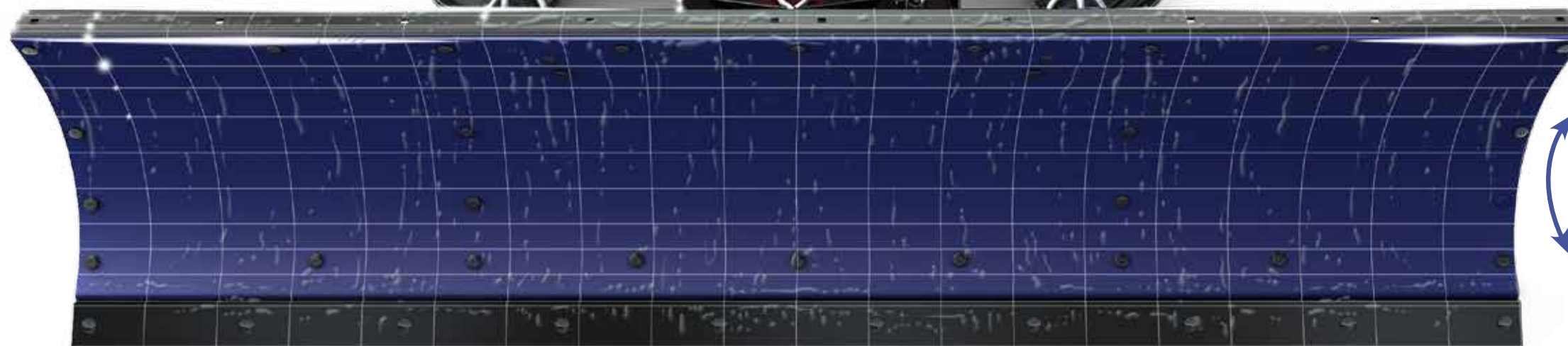

CLEAR THE WAY

**DEPENDABLE. TOUGH.
BUILT FOR THE OFF-ROAD.**

- ✓ Tested **1,200+** pulls at max load, so it works when you need it to
- ✓ Built to withstand **-29° C** temperatures
- ✓ Sealed motor & heavy duty gears
OPERATE FULLY SUBMERGED UNDERWATER
- ✓ **MILITARY** tested & approved
- ✓ **FULLY INTEGRATED** mount & wiring

HD HEAVY DUTY SERIES

3500 LB. (1588 KG) WINCH

15.25 M OF 4.7 MM PREMIUM HIGH-STRENGTH SYNTHETIC ROPE

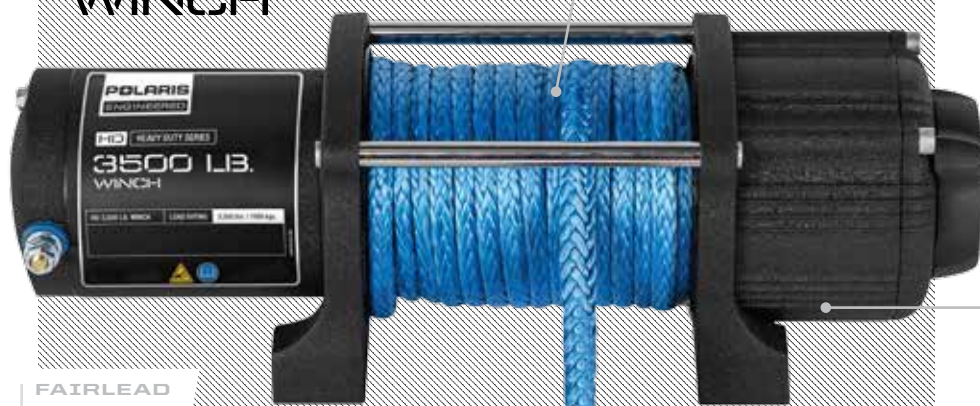

FAIRLEAD

POLARIS® HD 3500 LB (1588 KG) WINCH

- 1-year warranty
- » 2880434
X2 570 '15-18, TOURING 570 SP '15-18, TOURING 570 '14-18, ETX '15-16, 570 SP '15-18, 570 '14-18, 570 6X6 '17-18, 450 H.O. '16-18
- » 2880435 **TOP SELLER**
XP 1000 '15-18, TOURING XP 1000 '15-18, TOURING 850 SP '15-18, TOURING 850 '12-14, TOURING 550 '12-14, SCRAMBLER '13-18, 850/XP1000 HL '16-18, 850/850 SP '12-18, 550 '12-14
- » 2882106
POLARIS ACE® '14-16, POLARIS ACE® 900 XC '17-18, POLARIS ACE® 900 SP '16, POLARIS ACE® 570 SP '16-17, POLARIS ACE® 570 '15-18, POLARIS ACE® 500 '17-18

DURABLE, CORROSION-RESISTANT FINISH

HD HEAVY DUTY SERIES

2500 LB. (1134 KG) WINCH

15.25 M OF 4.7 MM HIGH-STRENGTH STEEL CABLE

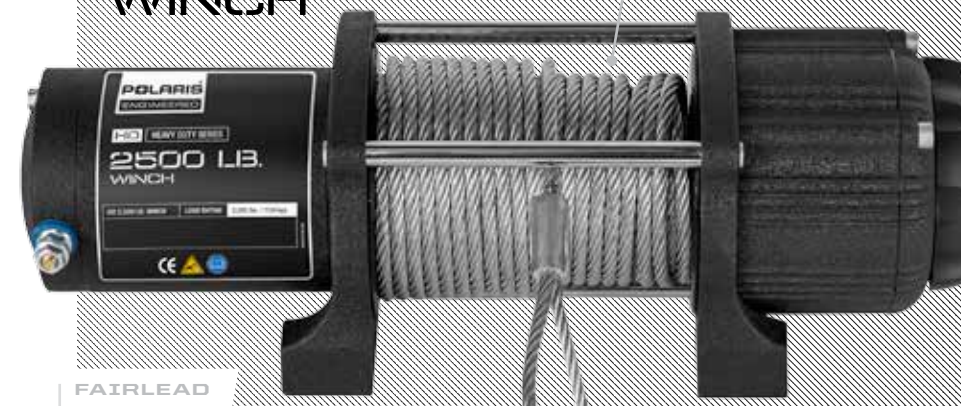

FAIRLEAD

POLARIS® HD 2500 LB (1134 KG) WINCH

- 1-year warranty
- » 2880432 **TOP SELLER**
X2 570 '15-18, TOURING 570 SP '15-18, TOURING 570 '14-18, ETX '15-16, 570 SP '15-18, 570 '14-18, 570 6X6 '17-18, 450 H.O. '16-18
- » 2880433
XP 1000 '15-18, TOURING XP 1000 '15-18, TOURING 850 SP '15-18, TOURING 850 '12-14, TOURING 550 '12-14, SCRAMBLER '13-18, 850/XP1000 HIGHLIFTER '16-18, 850/850 SP '12-18, 550 '12-14
- » 2882105
POLARIS ACE® '14-16, POLARIS ACE® 900 XC '17-18, POLARIS ACE® 900 SP '16, POLARIS ACE® 570 SP '16-17, POLARIS ACE® 570 '15-18, POLARIS ACE® 500 '17-18

RETRO FIT WIRE HARNESS

- » 4015094
LEGACY INSTALL

WINCH ACCESSORIES

POWER CONTROLLER

- Allows the rider to control plow angle and blade height from inside the cab

» 2880836

POLARIS ACE® 900 SP '16, POLARIS ACE® 570 SP '16-17, POLARIS ACE® 570 '15-18, POLARIS ACE® 500 '17-18, POLARIS ACE® '14-16



POLARIS® WIRELESS WINCH REMOTE

» 2879316

ALL SPORTSMAN® & POLARIS ACE® MODELS



UPGRADE YOUR HD WINCH WITH THESE ACCESSORIES



POLARIS® AUTO-STOP WINCH UPGRADE KIT

- Requires use of synthetic cable rope (not included)

» 2881693

ALL SPORTSMAN® & POLARIS ACE® MODELS



SYNTHETIC WINCH ROPE

- Includes pre-woven hook

» 2878888

3500 LB (1588 KG) & 2500 LB (1134 KG) WINCHES

WHY UPGRADE TO SYNTHETIC?

- Easier to work with - flexible and smooth texture
- More durable for plow usage
- Doesn't kink or bind like steel cable
- Lighter weight - even floats on water

GLACIER®

PLOW SYSTEM

When you have the power of a Glacier® Pro Plow System on your machine, you can truly take command of clearing snow and moving whatever you need to. Find the blade that fits your needs and you'll make quick work of even the heaviest jobs.



THE POLARIS ENGINEERED™ ADVANTAGE

INSTALLATION

30 seconds: Drive up, clip in, lock down, and go – the integrated Polaris Engineered™ Glacier® Plow System simplifies plowing.



CONVENIENCE

Lift and angle adjustments can be made from the driver's seat.

ANGLE YOUR BLADE RIGHT FROM YOUR SEAT WITH THE GLACIER® PRO PLOW HYDRAULIC ANGLE SYSTEM



ROBUST FRAME

A plow system is only as strong as its frame, and Polaris Engineered™ plow frames have a wide frame to withstand the rigors of heavy plowing.



DURABILITY

Available in strong stamped steel or corrosion-resistant poly materials, Polaris Engineered™ plow blades cover a large surface area for quick snow removal.

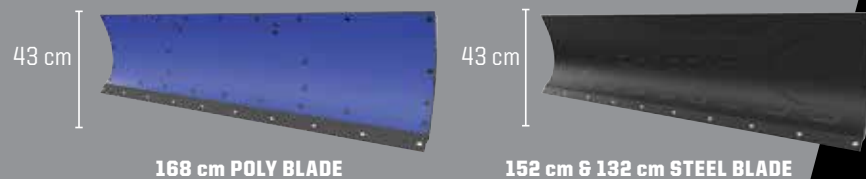

168 cm POLY BLADE

152 cm & 132 cm STEEL BLADE

BUILD YOUR PERFECT PLOW SYSTEM

GLACIER® PLOW SYSTEM



ANGLE YOUR BLADE RIGHT FROM YOUR SEAT WITH THE GLACIER® PRO PLOW HYDRAULIC ANGLE SYSTEM

1 SELECT A MOUNT

GLACIER® INTEGRATED PLOW MOUNT

- Fits all current Glacier® Pro Plow System components
- » 2881423
XP 1000 '15-18, TOURING XP 1000 '15-18, TOURING 850 SP '15-18, SCRAMBLER '15-18, 850/XP 1000 HIGHLIFTER '16-18, 850/850 SP '15-18
- » 2881424
X2 570 '15-18, TOURING 570 SP '15-18, TOURING 570 '15-18, ETX '15, 570 SP '15-18, 570 '15-18, 570 6X6 '17-18, 450 H.O. '16-18

PLOW MOUNT

- » 2879634
POLARIS ACE® '14-16, POLARIS ACE® 570 SP '16, POLARIS ACE® 570 '15-16
- » 2882107
POLARIS ACE® 900 XC '17-18, POLARIS ACE® 570 SP '17, POLARIS ACE® 570 '17-18, POLARIS ACE® 500 '17-18
- » 2879632
X2 850 '11-12, X2 550 '10-14, TOURING 850 '10-14, TOURING 550 '10-14, 850/850 SP '09-14, 550 '09-14
- » 2879633
TOURING 570 '14, TOURING 500 '13, 800 '12-14, 570 '14, 500 H.O. '12-13, 500 '12-14, 400 H.O. '12-14

2 SELECT A FRAME & ANGLE OPTIONS

GLACIER® PLOW FRAME

- » 2879630
ALL SPORTSMAN® & POLARIS ACE® MODELS
For use with Glacier® Pro Sportsman® and Polaris ACE® plow systems

GLACIER® PRO PLOW HYDRAULIC ANGLE SYSTEM

- Angle your plow blade with the push of a button so you can clear more snow or other material
- » 2879635
Power Controller Recommended (2880836)
For use with Glacier® Pro Sportsman® and Polaris ACE® plow systems

POWER CONTROLLER

- Allows the rider to control plow angle and blade height from the seat
- » 2880836
ALL POLARIS ACE® MODELS



3 CONFIGURE PLOW

POLARIS® HD 3500 LB (1588 KG) WINCH

See page 22.

POLARIS® HD 2500 LB (1134 KG) WINCH

See page 23.

PLOW WINCH ROPE

- Improved durability for plow use vs. steel cable
- Thicker than standard synthetic rope
- 8' (2.4m) of 0.25" (6mm) braided rope
- » 2878483
FOR USE WITH 2500 LB (1134 KG) & 3500 LB (1588 KG) WINCHES

4 SELECT A BLADE

GLACIER® PLOW BLADES

- Requires plow blade frame for mounting (sold separately)
- Includes plow blade and metal wear bar
- » 168 cm • POLY • 2880269
- » 152 cm • STEEL • 2879638
- » 132 cm • STEEL • 2879639
FITS ALL SPORTSMAN® AND POLARIS ACE®

GOT TRACKS?



GLACIER® PRO PLOW TRACK EXTENSION

- » 2879719
• Plow extension for use when using the prospector pro track system and Glacier® Pro Sportsman® or Polaris ACE® plow system

FOR USE WITH GLACIER® PRO SPORTSMAN® AND POLARIS ACE® PLOW SYSTEMS

SELECT ACCESSORIES

PLOW BLADE SNOW DEFLECTOR

- » 168CM • 2879866
- » 152 CM • 2871808

QUICK RELEASE SKID SHOES

- Helps prevent blade wear
- Hardened steel for industrial strength
- » 2877245

GLACIER® PRO SHEAR PIN

- » 2205063

WEAR BARS

• Protect your plow blade and minimize wear on the actual blade by installing Wear Bars

- » 168 CM • 2879867
- » 152 CM • 2871806

- » HD 168 CM • 2879868
- » 132 CM • 2877210

COIL SPRING SPACER

• Keep the front end of the vehicle up and improve ride quality when using a plow on strut or A-arm vehicles

- » 2872655

PLOW MARKER

• Helps driver monitor plow blade position

- Sold in pairs
- » 2872726

SHEAR PIN REPLACEMENT

• Direct replacement for a Glacier® Pro ATV Plow System Shear Pin

- » 2205063

TIRES



Polaris® and Pro Armor® developed a deep partnership thanks to having similar histories and passion for producing products that enhance vehicle performance. Each wheel and tire Pro Armor® designs and engineers for Polaris® off-road vehicles perform perfectly in the intended environment for its intended use. Developed, tested, and produced in partnership so you can tackle the terrain ahead.

10-PLY

Pro Armor® builds the toughest tires to keep you running when the terrain turns tough. A higher ply rating means added protection. Choose your tire and ply rating based on use and overall performance needs.

DUAL COMPOUNDS

You don't ride or drive in the same terrain, so Pro Armor® builds certain tires with multiple wear zones. A dual-durometer design allows the tire to wear better with softer outer lugs and harder inner lugs.



TRIPLE-BELTED SIDEWALLS

Sidewalls can be a vulnerable area of any off-road tire. Rocks jump out at your machine and tear into sidewalls. Thanks to reinforced construction in this critical area, Pro Armor® resists when others fail.

TORTURE-TESTED TOUGH

We set out to develop the best-performing, tightest-sealing cab on any utility side-by-side. Talk is cheap without proven results. Dust, water, noise—all proved troublesome for the competition, but not for RANGER Pro Shield™. **The results speak for themselves.**

TIRE: **DUAL-THREAT**

WHEEL: **BUCKLE ACCENT**

4,828 km RATED

Pile on the miles with Pro Armor® tires. Every tire is designed and constructed with longevity in mind. With ratings of 4,828 km and beyond, you are assured long life and performance.

KNOW YOUR TIRES

DIMENSIONS
28" x 9" R14
TIRE HEIGHT | TIRE WIDTH | WHEEL DIAMETER

TREAD DEPTH
A deeper tread means more grip and better performance

WEIGHT
A lighter tire makes for improved vehicle performance

PLY RATING
Indicates the overall load capability of the tire

SIDEWALL BELTS
Sidewall belts increase your resistance to sidewall punctures

LOAD RATING
Tires with higher load ratings can handle more weight

PADDLE DEPTH
Increases grip and performance in the sand

TRAIL



FRONT

REAR

PRO ARMOR® DUAL-THREAT **NEW**

Engineered with dual-compound technology and radial construction to offer revolutionary off-road performance in all terrains. The lateral-grip compound on the outer edges of the tire has a softer durometer rubber for cornering performance and superior grip. The long-wearing compound in the middle of the tire has harder durometer rubber for increased traction during acceleration, straight line stability, and overall longer tread life.

- 14" 26" x 9" R14 • FRONT • 5416340
- 14" 26" x 11" R14 • REAR • 5416341

	TREAD DEPTH	WEIGHT	PLY RATING	SIDEWALL BELTS	LOAD RATING
FRONT	16mm	12 kg	10	3	413 kg
REAR		14 kg			499 kg



UTILITY



WHEEL SIZE

14" 12"

WHEEL SIZE

14" 12"

WHEEL SIZE

12"



PRO ARMOR HARVESTER

- All-around workhorse with tread life of 8,047 km. Tread pattern designed to withstand anything from the farmyard and to the pastures to the trail.
- With 10-Ply, it can carry the load day in and day out.

- 14" 27" x 10" R14 • 5415965
- 14" 26" x 8" R12 • 5416396
- 12" 26" x 10" R12 • 5415966

PRO ARMOR PRESERVE **NEW**

- Turf-friendly for areas where low impact from tire tread is needed.
- Exceptionally quiet-running tire.

- 14" 27" x 10" R14 • 5416348
- 12" 26" x 8" R12 • 5416403
- 12" 26" x 10" R14 • 5416402

PRO ARMOR XD-K

- 26" Aramid fiber-belted tire can tackle any terrain.
- Unique full-face tread design.
- Harder durometer lugs promote for extended wear increasing tire life.

- 12" 26" x 9" R12 • 5415756
- 12" 26" x 11" R12 • 5415757



FRONT / REAR

PRO ARMOR ATTACK

- The best all-purpose tire for all-season traction in any terrain.
- Unique full-face tread design.
- Harder durometer lugs promote extended wear, increasing tire life.

- 14" 26" x 9" R14 • FRONT • 5415613
- 14" 26" x 11" R14 • REAR • 5415614

	TREAD DEPTH	WEIGHT	PLY RATING	SIDEWALL BELTS	LOAD RATING
FRONT	23mm	13 kg	8	3	413 kg
REAR		15 kg			599 kg



	TREAD DEPTH	WEIGHT	PLY RATING	SIDEWALL BELTS	LOAD RATING		TREAD DEPTH	WEIGHT	PLY RATING	SIDEWALL BELTS	LOAD RATING		TREAD DEPTH	WEIGHT	PLY RATING	SIDEWALL BELTS	LOAD RATING
26"	16mm	FRONT	11 kg	10	3		26"	16mm	10	3	388 kg		FRONT	13 kg	8	3/1 Aramid	424 kg
		REAR	15 kg										599 kg	REAR			
27"	FRONT/REAR	15 kg			599 kg	27"	FRONT/REAR	13 kg			599 kg						

SNOW



FRONT / REAR

PRO ARMOR WHITEOUT

- Extra wide tires for flotation in snow.
- Tread pattern designed for superior snow traction with limited digging.

- 14" 27" x 14" R14 • FRONT/REAR • 5416032

	TREAD DEPTH	WEIGHT	PLY RATING	SIDEWALL BELTS	LOAD RATING	
FRONT	27" R14	16mm	12 kg	8	3	424 kg
REAR						



MUD



FRONT

REAR

PRO ARMOR DAGGER

- From the trails to the pits, this tire gets you through it all.
- Deep, self-cleaning lug and wide tire design for exceptional mud pit performance.
- Rounded profile and full lug pattern for on-trail comfort.

- 14" 27" x 9" R14 • FRONT • 5415617
- 14" 27" x 11" R14 • REAR • 5415618

	TREAD DEPTH	WEIGHT	PLY RATING	SIDEWALL BELTS	LOAD RATING
FRONT	38mm	15 kg	8	3	499 kg
REAR		18 kg			531 kg





A AMPLIFY

ACCENT: FRONT 14" x 7" • 1522956-266
 REAR 14" x 8" • 1522957-266
 MATTE BLACK: FRONT 14" x 7" • 1522956-458
 REAR 14" x 8" • 1522957-458

B BUCKLE

ACCENT: FRONT 14" x 7" • 1522544-266
 REAR 14" x 8" • 1522545-266
 MATTE BLACK: FRONT 14" x 7" • 1522544-458
 REAR 14" x 8" • 1522545-458

C COMBAT NEW
(BEADLOCK RINGS INCLUDED)

ACCENT: 14" x 7" • 1523284
 MATTE BLACK: 14" x 7" • 1523283

D REBLR (REQUIRES BEADLOCK RINGS)

MATTE BLACK: FRONT 14" x 7" • 1522238-458
 REAR 14" x 8" • 1522239-458

E SIXR

MATTE BLACK: FRONT 14" x 7" • 1521507-521
 REAR 14" x 8" • 1521508-521
 LUSTER: FRONT 14" x 7" • 1521507-410
 REAR 14" x 8" • 1521508-410
 MACHINED: FRONT 14" x 7" • 1521507-266
 REAR 14" x 8" • 1521508-266

F SHACKLE

ACCENT: FRONT 14" x 7" • 1522546-266
 REAR 14" x 8" • 1522547-266
 MATTE BLACK: FRONT 14" x 7" • 1522546-458
 REAR 14" x 8" • 1522547-458

G SPLIT

MATTE BLACK: FRONT 14" x 6" • 1522542-458
 REAR 14" x 8" • 1522543-458

H THRASHER

MATTE BLACK: FRONT 14" x 6" • 1522241-458
 REAR 14" x 6" • 1522242-458

I WHITEOUT

MATTE BLACK: 14" x 10" • 1522958

Replacement BEADLOCK RING 14"
 1523146-458 • MATTE BLACK
 FITS COMBAT WHEEL ONLY



FORGED BEADLOCK RINGS

- Only used on REBLR wheels. 14" beadlock rings
- Sold individually

VooDoo Blue
 14" • 1522244-619

Machined
 14" • 1522244-266

White
 14" • 1522244-133

Indy Red
 14" • 1522244-293

Orange Crush
 14" • 1522244-589

TIRE SEALANT

3.7 Liters
 2830485

19 Liters
 2830486

19 Liter Pump
 2830487

946 ml
 2830484



14" SETS

TIRES	ANARCHY	ATTACK	DAGGER	DUAL-THREAT 26"	PRESERVE 27"	HARVESTER 27"	WHITEOUT 27"
WHEELS							
AMPLIFY Accent	2882402	2882390	2882392	2883138	2883208	2882388	
AMPLIFY Matte Black	2882403	2882391	2882393	2883139	2883209	2882389	
BUCKLE Accent	2881341	2881335	2881337	2883140	2883203	2882383	
BUCKLE Matte Black	2881342	2881336	2881338	2883141	2883204	2882384	
COMBAT Accent <small>*BEADLOCKS PRE-MOUNTED</small>				2883217			
COMBAT Matte Black <small>*BEADLOCKS PRE-MOUNTED</small>				2883216			
REBLR Matte Black <small>*BEADLOCKS SOLD SEPARATELY</small>		2881381	2881383				
SHACKLE Accent	2881353	2881347	2881349	2883142	2883205	2882385	
SHACKLE Matte Black	2881354	2881348	2881350	2883143	2883206	2882386	
SIXR Luster		2881359	2881362				
SIXR Matte Black	2881369	2881360	2881363	2883144	2883207	2882387	
SPLIT Matte Black		2881404	2881405	2883145			
THRASHER Matte Black	2881446	2881378	2881380				
WHITEOUT R14 Matte Black							2882382

LUGS



10MM X 1.25 HEX LUG NUTS

- » 2877385 • 4 HEX LUG NUTS
- » 2877384 • 16 HEX LUG NUTS Sportsman™ XP

3/8" - 24 HEX LUG NUTS

- » 2876754 • 4 HEX LUG NUTS
- » 2877409 • 16 HEX LUG NUTS Polaris ACE™, SPORTSMAN™ 450/570

REPLACEMENT CAPS



POLARIS™ CAPS

- » 1521509-410 • LUSTER
- » 1521509-521 • MATTE BLACK AMPLIFY, BUCKLE, COMBAT, REBLR, SHACKLE, SIXR, SPLIT, WHITEOUT
- » 1522243-410 • LUSTER
- » 1522243-458 • MATTE BLACK THRASHER



PRO ARMOR™ CAPS

- » 5453209-410 • LUSTER
- » 5453209-458 • MATTE BLACK AMPLIFY, BUCKLE, COMBAT, REBLR, SHACKLE, SIXR, SPLIT, WHITEOUT
- » 1523015-410 • LUSTER
- » 1523015-458 • MATTE BLACK THRASHER

ALL-TERRAIN TRACTION

It's tough to make Sportsman® and Polaris ACE® even more versatile than they already are. But with a set of Prospector Pro® Tracks, you'll do just that. Tread through deep snow without concern.

Polaris®-specific gearing provides 1:1 ratio to:

- Minimize track slip, providing better climbing ability and improved traction in deep snow
- Improve top speed over prior models by approximately 5%
- Reduce operating RPM for a quieter ride
- Improve driveline durability, which allows vehicle to run at a lower RPM, decreasing engine wear

Polaris® Exclusive optimized hub geometry that minimizes feedback and eases steering effort

Flexible lug design provides the highest level of deep snow performance by lifting up in deep snow as opposed to digging down

New front dual stabilizer for improved stability

Lightweight design provides for better flotation, eases steering effort, and provides better vehicle control



PROSPECTOR PRO
TRACK SYSTEM

POLARIS® INTERACTIVE DIGITAL DISPLAY 2.0



1. Speedometer
2. Real-Time Clock
3. Compass
4. Tachometer
5. Coolant Temperature
6. Gear Position
7. Odometer Trip Meter
8. Fuel Level Indicator
9. 4x4 Indicator

STANDARD FEATURES

- Control of Bluetooth® audio media streaming with track and artist display
- Exporting capabilities for created tracks and waypoints from the display to USB drive
- Course-up arrow option with rotating background map now available
- Distance to a selected waypoint shown on the map screen
- Automatic day/night brightness change based on time of day and day of year
- New riding screen with increased visibility to important diagnostics, gear indicator enlarges on gear change
- High resolution, 11 cm full color LCD display
- Bluetooth® connectivity allows you to pair your smart phone and check missed calls, text message, battery life and signal strength
- Diagnostics screen displays vehicle fault codes (NEW: Voltage and engine temp faults will pop up and turn red at critical levels)
- GPS connectivity offers exact location information including elevation, latitude/longitude, and compass bearings

» 2881554
POLARIS ACE®, SPORTSMAN XP®, SPORTSMAN® SP
Must purchase Sportsman® Install Kit (2880536)

POLARIS® INTERACTIVE DIGITAL DISPLAY INSTALL KIT

• Includes all installation hardware and harnesses

» 2880536
XP 1000 '15-16, TOURING XP 1000 '15-18, TOURING 850 SP '15-18, TOURING 570 SP '15-18, 850/850 SP '15-16, 570 SP '15-18, 570 6X6 '17-18, 450 H.O. '18, 570 '18

» 2880537
POLARIS ACE® 900 XC '17-18, POLARIS ACE® 900 SP '16, POLARIS ACE® 570 SP '16-17, POLARIS ACE® 570 '15-18, POLARIS ACE® 500 '17-18, POLARIS ACE® '14-16

» 2882275
XP 1000 '17-18, 850/850 SP '17-18



GPS connectivity offers exact location information, including elevation, latitude/longitude, and compass bearings

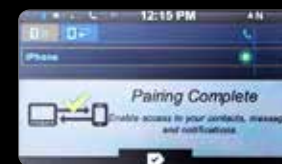

Bluetooth® functionality allows you to see your missed calls and text messages on the display



TPS, RPM, and ground speed playback for up to 90 seconds to easily monitor your vehicle's performance

1 SELECT A MOUNT

PROSPECTOR PRO® MOUNT

- Dual bogie wheels manage weight properly & deliver a great ride & outstanding traction in snow

» 2879457

X2 850 '11-12, X2 550 '10-14, TOURING XP 1000 '17-18, TOURING 850/850 SP '10-18, TOURING 550 '10-14, SCRAMBLER '13-18, 850/850 SP '10-18, 550 '10-14, XP 1000 '15-16

» 2879497

X2 570 '15-18, TOURING 570 '14-18, ETX '15, 800 '12-14, 570 '14-18, 500 H.O. '12-13, 500 '12-14, 450 H.O. '16-18, 400 H.O. '13-14

- High Clearance Track Mount Kit
- Track sold separately

» 2879751

POLARIS ACE® 570 '15, POLARIS ACE® '14-15,

» 2883019

POLARIS ACE® 570 '16-17, POLARIS ACE® 500 '17, POLARIS ACE® '16

2 SELECT A KIT

PROSPECTOR PRO® TRACKS

- Polaris® track systems deliver the utmost in performance and productivity, with absolutely no compromise of vehicle cargo capacity or pulling power.

» 2879720

XP 1000 '15-16, X2 850 '11-12, X2 550 '10-14, TOURING 850 '10-14, TOURING 550 '10-14, 850/850 SP '09-15, 850 MY16-18 (NON-EPS), 550 '09-14

» 2881003

XP 1000 '15-16, TOURING XP 1000 '15-18, TOURING 850 SP '15-18, SCRAMBLER '15-18, 850/850 SP '15-18 (EPS)

- They deliver the best in performance, reliability, durability and value in every season.

» 2881025

X2 570 (EPS) '15-18, TOURING 570 SP '15-18, 570 SP '15-18, 570 '16-18 (EPS)

» 2880020

X2 570 '17-18, TOURING 570 '14-18, TOURING 500 '13, ETX '15, POLARIS ACE® 570 '15-16, POLARIS ACE® '14-16, 800 '12-14, 570 '14-18, 500 H.O. '12-13, 500 '12-14, 450 H.O. '16-18, 400 H.O. '12-14

PROSPECTOR PRO® TRACK SYSTEM (6X6)

- Includes Track Mount & Track Kit

» 2882169

570 6X6 '17-18

QUICKTAP BATTERY POSTS

- Easy-to-access terminal posts give you quick access to the battery power
- Ideal for charging your battery, powering a temporary accessory, or when you need to offer an unexpected jump-start
- Connection posts feature covers to protect terminals when not in use

» 2882110 •

X2 570 '15-18, TOURING 570 '14-18, 570 SP '15-18, 570 '14-18, 570 6X6 '17-18

INTRODUCING

RIGID®



LIGHTING

ADVANCED TECH

Rigid® lights are driven by Aluminum PCB Smart Boards™ with copper thermal conductive pads, gold-plated electrical contacts, 6063-T5 aircraft aluminum extruded housings treated with Alodine® corrosion preventive, and Tiger Drylac® UV protection polyester powder coating.

EXCLUSIVE OPTICS

RIGID® hand-selects the brightest high-tech LEDs from the best manufacturers. The LEDs shine through patented optics that maximize total light output and efficiency. RIGID® lights feature impact-resistant polycarbonate lenses for a 100% water/dustproof seal.

RUGGED STYLING DURABLE CONSTRUCTION

Pro Armor® lights are designed to be big and beefy with an aggressive style all their own. Housed in IP67 marine-grade rated UV Polyester powder-coated with precision-cast end panels and oversized, extruded aluminum heat sinks to keep the temperature down.

MASSIVELY BRIGHT

Counting up to 66 3-5 watt Cree® LEDs pushing over 11,000 lumens, Pro Armor® lights are some of the brightest in the industry. All that power is directed through heat-dissipating aluminum printed circuit boards for streamlined heat management.

RIGID® LIMITED LIFETIME WARRANTY* BREAK YOUR LIGHT AND RIGID® WILL REPLACE OR REPAIR IT FOR LIFE

8 BEAM PATTERNS

Select from 15 to 90 degrees—the pattern changes when and how you want it.

750 M
500 M
250 M

750 M
500 M
250 M

NEW RIGID® ADAPT 25 cm LED

8 beam patterns that can adjust with changing conditions

LUMENS: 7,360

» 2883125

Coming fall 2018



MATCH YOUR STYLE

Choose from any color in the spectrum to reflect your style or current mood.



CHANGE FROM THE DASH

A backlit, molded dash controller allows you to control the beam pattern and color.

NEW RIGID® SR-SERIES PRO DRIVING LED

LUMENS: 4,752

» 2883128

Comes in a pair

NEW RIGID® SR-SERIES PRO FLOOD LED

LUMENS: 3,168

» 2883126

Comes in a pair

NEW RIGID® SR-SERIES PRO SPOT LED

LUMENS: 3,168

» 2883127

Comes in a pair

NEW RIGID® SR-SERIES PRO 25 cm COMBO LED

LUMENS: 7,920

» 2883123

NEW RIGID® SR-SERIES PRO 25 cm FLOOD LED

LUMENS: 7,920

» 2883122

NEW RIGID® SR-SERIES PRO 25 cm SPOT LED

LUMENS: 7,920

» 2883121

NEW PRO ARMOR® 51 cm DUAL

LUMENS: 11,252

» 2883107

Only fits POLARIS ACE®

NEW PRO ARMOR® CUBE FLOOD

LUMENS: 1,300

» 2882312

Each or single light

NEW PRO ARMOR® CUBE SPOT

LUMENS: 1,260

» 2882076

Each or single light

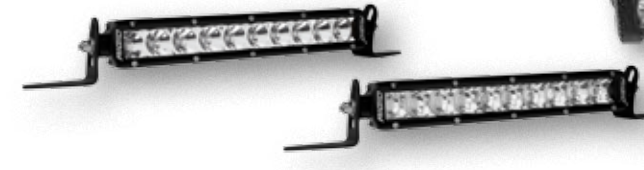
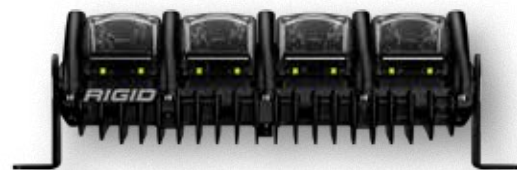

WIRING HARNESSES

LED LIGHT BAR HARNESS

» 2882320
ALL SPORTSMAN® MODELS

LED HARNESS WITH TWO CONNECTORS

• Y-Harness requires 2882320 or 2879859 to control two cube lights with one switch
» 2879860

LED LIGHT BAR HARNESS

» 2879859
ALL POLARIS ACE® MODELS

ACCENT LIGHTING KIT

- Set includes four LED pods
- Durable off-road ready construction that is both dust- and water-resistant

SINGLE ACCENT LIGHT

- Durable off-road ready construction that is both dust- and water-resistant
- Features Cree® LED for a long-lasting, brilliant light

COLOR	LIGHTING KIT	SINGLE LIGHT
RED	2880500	2880532
BLUE	2880506	2880533
WHITE	2881119	2881176
GREEN	2882378	2882379

ALL SPORTSMAN® MODELS AND POLARIS ACE®

BLUE XENON HEADLIGHT BULBS

- More than 50% brighter than stock bulbs
- » 2876464
XP '09-14, SPORTSMAN® '05-14



* If RIGID® determines, in its sole discretion, that your product is defective in material or workmanship, RIGID® will honor your warranty claim. In some cases the product will be replaced, depending on the specific time frame of the purchase. If the product is repaired, all parts, labor, and return shipping may be covered by RIGID®.

OFF-ROAD GRADE AUDIO



AUDIO PODS **POLARIS ACE**

- Two 20 cm coaxial speakers with 2.5 cm titanium tweeters in weatherproof enclosures
- Self-powered 200-watt per speaker output
- Backlit LED illumination selectable between red and blue
- » 2881227
ALL POLARIS ACE[®] MODELS
Requires Audio Harness (2882167)
- Rotating, low-profile, rubber isolated mounts
- Durable black satin finish
- Required to operate: Head unit or Bluetooth[®] Remote (2881470)



BLUETOOTH[®] AUDIO REMOTE **POLARIS ACE**

- Bluetooth[®] technology allows you to play music through speakers of choice
- Mount anywhere and control music with easy-to-use push-button pad
- » 2881470
ALL POLARIS ACE[®] MODELS
- » 2883113 **NEW**
ALL POLARIS ACE[®] MODELS



MTX[®] OVERHEAD AUDIO POD **POLARIS ACE**

- Bluetooth[®] connectivity for wireless audio
- USB port for charging mobile devices in waterproof storage locker
- LCD display shows audio information; convenient LED lights shine toward rider
- Auxiliary connection through headphone jack
- Dual 15 cm speakers and tweeters that direct sound toward rider
- Installs in less than 15 minutes; includes all wiring
- Durable, sealed, hard plastic black housing
- Can be used with a roof and windshield; not compatible with Overhead Storage Bag
- » 2879703
ALL POLARIS ACE[®] MODELS



SOUND BAR 4 **POLARIS ACE**

- Dual mid-range/mid-bass speaker and two dedicated tweeters
- Integrated, self-powered amplifier for easy installation
- Bluetooth[®] or wired audio input with variable output
- Large, easy-to-use external controls
- Aluminum, black finish housing with low profile, clamp-on mounts
- Includes mounts, audio bar, waterproof connections, and instructions
- » 2881230
ALL POLARIS ACE[®] MODELS
Requires Audio Harness (2882280)



WATERPROOF BLUETOOTH[®] AUDIO **POLARIS ACE** **SPORTSMAN**

- Kit includes four mounting configurations
- Mounts easily to the handlebars or roll cage or fits in your dashboard storage area
- IPX4-rated for water and dust resistance
- Internal LiPo rechargeable battery provides 12 hours of music between charges
- » 2880458
ALL SPORTSMAN[®] & POLARIS ACE[®] MODELS



BE PREPARED AND GET MORE DONE



POLARIS® SPORTSMAN® & POLARIS ACE® ESSENTIAL ACCESSORIES



TIE-DOWN RATCHET STRAPS

- » 2859047-01 • RED
- » 2859047-02 • BLACK



SHOCKSTRAP

- » 2883295 • 15 cm (2 PACK)
- » 2883296 • 3.8 cm X 213 cm (2 PACK)



LOCK & RIDE PLUNGER

- » 2876420
- ALL SPORTSMAN® AND POLARIS ACE®



LOCK & RIDE D-RING PLUNGER

- » 2881544
- ALL SPORTSMAN® AND POLARIS ACE®



RIDE & REPAIR ESSENTIALS KIT

- 12-volt DC portable air compressor
- Tire repair kit with 6 plugs
- Basic first-aid kit with bandages, scissors, safety pins, and more
- 12-volt jumper cables
- Duct tape - 300mm x 1 roll
- Zip ties - 150mm length
- Electrical tape
- Ratchet strap - 50mm
- Microfiber cloth
- Carry bag

- » 2881207



SPORTSMAN® BOOM SPRAYER - 57 L

- » 2882266
- ALL SPORTSMAN® MODELS EXCEPT TOURING



HANDLEBAR HAND WARMERS

- Keep both hands warm while riding
- Complete kit includes all wiring

- » 2877363
- ALL SPORTSMAN® MODELS

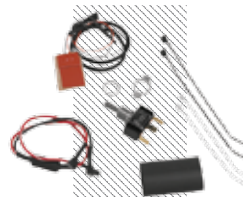

THROTTLE/THUMB WARMERS

- Keeps throttle thumb warm
- Complete kit includes all wiring

- » 2877364
- ALL SPORTSMAN® MODELS



HANDLEBAR-MOUNTED MIRROR

- For added safety on or off the trail

- » 2877222
- ALL SPORTSMAN® MODELS



LICENSE PLATE KIT

- » 2873270
- ALL SPORTSMAN® MODELS

FOX® SHOCK: XP

- » 2879892
- XP 1000 '15-16, 850/XP 1000 HL '16-18, 850/850 SP '09-16, 550 '09-14
- FOX® is a registered trademark of Fox Factory Inc.

TOTAL FREEDOM REALIZED



POLARIS ACE® 900 XC
HAVASU VELOCITY BLUE

Run your favorite trail in the machine you want that's built the way you want. Accessorize your Polaris ACE® 900 to express your passion, and step up your experience. Roofs, windshields, lower doors, and more await your vision.

SHOWN WITH:

A. AUDIO PODS • 2881227

B. LOWER DOOR EXTENSIONS • 2880272

C. LOCK & RIDE CARGO BOX • 2881447

D. XC FRONT BUMPER • 2882258

E. LOCK & RIDE FLIP-DOWN WINDSHIELD
HARD COAT POLY • 2882443

F. LOCK & RIDE SPORT ROOF - POLY • 2881147



TAKE ON

THE TRAIL

POLARIS ACE 570 SP
TITANIUM MATTE METALLIC



NEW POLARIS ACE® 150

THE ONLY SINGLE SEAT
YOUTH ATV WITH A
FULL CAB FRAME



Make it happen. Build it the way you want. Write a story of freedom and adventure on the trail in your Polaris ACE® 570. It's there for the taking. What are you waiting for?

SHOWN WITH:

- A. FOLDING SIDE MIRRORS • 2881517
- B. **LOCK & RIDE** SPORT ROOF - POLY • 2881147
- C. MTX® OVERHEAD AUDIO POD • 2879703
- D. **LOCK & RIDE** MID WINDSHIELD - POLY • 2879694
- E. LOWER DOOR EXTENSION • 2880272
- F. PRO ARMOR® WHEEL & TIRE SET: SIXR - LUSTER & ATTACK • 2881359
- G. POLARIS NORTHSTAR® COOLER - 28 L • 2881315
- H. SPARE TIRE MOUNT • 2881150
- I. REAR ROPS EXTENSION • 2881154

- A. POLY ROOF
» 2882263
POLARIS ACE® 150 '17-18
- B. HALF WINDSHIELD
» 2882264
POLARIS ACE® 150 '17-18
- C. FRONT & REAR BRUSHGUARD
» 2882472
POLARIS ACE® 150 '17-18

COMFORTABLE AND CAPABLE



LOCK & RIDE
FLIP-DOWN WINDSHIELD
- HARD COAT POLY

• In its up position, experience full protection from wind, mud, rain, or whatever you encounter

» 2882443
 POLARIS ACE® '14-16, POLARIS ACE® 900 XC '17-18, POLARIS ACE® 900 SP '16, POLARIS ACE® 570 SP '16-17, POLARIS ACE® 570 '15-18, POLARIS ACE® 500 '17-18



A SPORT DOORS

- Steel frame and strong plastic exterior
- Premium fit and finish; no cutting, welding, or drilling required
- Add style with custom POLARIS ACE® Sport Door Graphics (sold separately)

» 2881429
 POLARIS ACE® '14-16, POLARIS ACE® 900 XC '17-18, POLARIS ACE® 900 SP '16, POLARIS ACE® 570 SP '16-17, POLARIS ACE® 570 '15-18, POLARIS ACE® 500 '17-18

B LOWER DOOR EXTENSIONS

- Extensions install on Sport Doors (2879697, sold separately) and create a single, integrated door unit
- Extensions feature strong, durable steel frame with black hard-plastic exterior

» 2880272
 POLARIS ACE® '14-16, POLARIS ACE® 900 XC '18, POLARIS ACE® 900 SP '16, POLARIS ACE® 570 SP '16, POLARIS ACE® 570 '15-18, POLARIS ACE® 500 '18



CANVAS CAB

- Cab provides riders with protection and enhanced comfort for a more enjoyable riding experience
- Included are: canvas roof/rear panel and canvas doors
- Components can be used to suit rider preference and the day's conditions, i.e., doors can be easily removed to suit conditions
- Doors and rear panel feature clear plastic windows for excellent visibility
- Doors feature aluminum frames with durable canvas exterior and durable, reliable hinges and latches
- Requires the use of accessory Full Poly Windshield (2879693; sold separately)
- Requires the removal of accessory Polaris ACE® Sport Doors (2879697) if previously installed

» 2880646
 POLARIS ACE® '14-16, POLARIS ACE® 900 XC '17-18, POLARIS ACE® 900 SP '16, POLARIS ACE® 570 SP '16-17, POLARIS ACE® 570 '15-18, POLARIS ACE® 500 '17-18



LOCK & RIDE FULL WINDSHIELD - POLY

• Windshield is made of impact- and shatter-resistant .449 cm polycarbonate with hard coat on both sides

» 2879693
 POLARIS ACE® '14-16, POLARIS ACE® 900 XC '17-18, POLARIS ACE® 900 SP '16, POLARIS ACE® 570 SP '16-17, POLARIS ACE® 570 '15-18, POLARIS ACE® 500 '17-18



LOCK & RIDE MID WINDSHIELD - POLY

• Provides protection while also allowing airflow to reach the rider

• Strong, durable, impact-resistant polycarbonate
 » 2879694
 POLARIS ACE® '14-16, POLARIS ACE® 900 XC '17-18, POLARIS ACE® 900 SP '16, POLARIS ACE® 570 SP '16-17, POLARIS ACE® 570 '15-18, POLARIS ACE® 500 '17-18



LOCK & RIDE REAR PANEL - POLY

• Can be used with other accessories such as roof, cargo bags, etc.

» 2879696
 POLARIS ACE® '14-16, 570 SP '15-16, 570 '16
 » 2881774
 POLARIS ACE® 900 XC '17-18, POLARIS ACE® 900 SP '16, POLARIS ACE® 570 SP '17, POLARIS ACE® 570 '17-18, POLARIS ACE® 500 '17-18

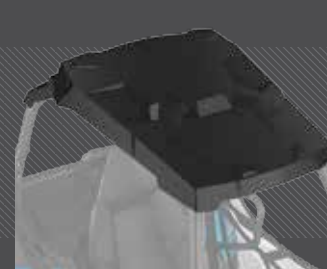

LOCK & RIDE SPORT ROOF - POLY

• Works with Rear Rops Extender 2881154

» 2881147
 POLARIS ACE® '14-16, POLARIS ACE® 900 XC '17-18, POLARIS ACE® 900 SP '16, POLARIS ACE® 570 SP '16-17, POLARIS ACE® 570 '15-18, POLARIS ACE® 500 '17-18



CANVAS ROOF

• Roof attaches securely to vehicle frame using integrated, self-locking mounting hardware

» 2879692
 POLARIS ACE® '14-16, POLARIS ACE® 900 XC '17-18, POLARIS ACE® 900 SP '16, POLARIS ACE® 570 SP '16-17, POLARIS ACE® 570 '15-18, POLARIS ACE® 500 '17-18



SIDE MIRRORS

• Hinges feature breakaway design for tight trail conditions and easy trailering

» 2881517
 POLARIS ACE® '14-16, POLARIS ACE® 900 XC '17-18, POLARIS ACE® 900 SP '16, POLARIS ACE® 570 SP '16-17, POLARIS ACE® 570 '15-18, POLARIS ACE® 500 '17-18



REAR VIEW MIRROR

• Can be used in conjunction with accessories such as roof, windshield, etc.

» 2879712
 POLARIS ACE® '14-16, POLARIS ACE® 900 XC '17-18, POLARIS ACE® 900 SP '16, POLARIS ACE® 570 SP '16-17, POLARIS ACE® 570 '15-18, POLARIS ACE® 500 '17-18

PROTECT YOUR RIDE



BED EXTENDER **NEW**

- Creates up to 106 liters of storage volume on your storage bed
- Adds 11 cm of height to the rear perimeter of storage bed
- Steel construction

» 2882886

ALL POLARIS ACE™ MODELS



SUBZERO HARNESS **NEW**

- Exclusive controlled deceleration tech
- Easy one-click buckle
- Secure restraint allows for improved vehicle control

» 2882281

POLARIS ACE™ 500 '18, POLARIS ACE™ 570 '18, POLARIS ACE™ 900 XC '18



SKID PLATE

- Strong, durable, lightweight .95 cm HMW (high-molecular weight) polyethylene construction

» 2880543

POLARIS ACE™ '14-16, POLARIS ACE™ 900 SP '16, POLARIS ACE™ 570 SP '16-17, POLARIS ACE™ 570 '15-18, POLARIS ACE™ 500 '17-18

FRONT RACK EXTENDER **NEW**

- Increase front rack carrying capacity
- 10 cm -tall support design around the front and side perimeter of the rack

» 2882885

ALL POLARIS ACE™ MODELS

- Steel construction
- Angular design enhances the look of your machine
- Easily mounts with four bolts



XC BUMPER

- Contoured steel tube design fits perfectly and flows with the sculpted design cues of the Polaris ACE™ 900 XC

» FRONT • 2882258

POLARIS ACE™ 900 XC '17-18



XC BUMPER

- Contoured steel tube design fits perfectly and flows with the sculpted design cues of the Polaris ACE™ 900 XC

» REAR • 2882259

POLARIS ACE™ 900 XC '17-18



EXTREME BRUSHGUARD

- Strong 1.25" (3.2cm) diameter steel tube construction with a durable, scratch-resistant black powder-coated finish

» FRONT • 2882504

POLARIS ACE™ '14-16, POLARIS ACE™ 900 SP '16, POLARIS ACE™ 570 SP '16-17, POLARIS ACE™ 570 '15-18, POLARIS ACE™ 500 '17-18



EXTREME BRUSHGUARD

- Strong 1.25" (3.2cm) diameter steel tube construction with a durable, scratch-resistant black powder-coated finish

» REAR • 2882924

POLARIS ACE™ '14-16, POLARIS ACE™ 900 SP '16, POLARIS ACE™ 570 SP '16-17, POLARIS ACE™ 570 '15-18, POLARIS ACE™ 500 '17-18



FENDER FLARE KIT

- Extends bodywork additional 8 cm for extra protection from mud and water

» 2879718

POLARIS ACE™ 900 SP '16, POLARIS ACE™ 570 SP '16-17, POLARIS ACE™ 570 '15-17, POLARIS ACE™ 500 '17, POLARIS ACE™ '14-16



LOW PROFILE ROCK SLIDERS

- Low-profile design hugs bodywork without compromising ground clearance

» 2881151

POLARIS ACE™ 900 SP '16, POLARIS ACE™ 570 SP '16-17, POLARIS ACE™ 570 '15-17, POLARIS ACE™ 500 '17, POLARIS ACE™ '14-16

Expanding Anchor Technology - minimal tools required



NERF BARS

- 13 cm kick-out protects the side of the vehicle, acting as a buffer between the vehicle and obstacles

» 2879700

POLARIS ACE 900 SP '16, POLARIS ACE 570 SP '16-17, POLARIS ACE 570 '15-17, POLARIS ACE 500 '17, POLARIS ACE '14-16



BODY ARMOR

- Helps protect vehicle plastics

» 2882087

POLARIS ACE™ '14-16, POLARIS ACE™ 570 SP '16-17, POLARIS ACE™ 570 '15-17, POLARIS ACE™ 900 SP '16, POLARIS ACE™ 500 '17



LOOK & RIDE

REAR CARGO BOX

- Installs without tools using twin Lock & Ride™ plungers, locks into vehicle's cargo space
- Handles make it easy to carry Cargo Box to and from vehicle
- D-rings on top of box serve as tie-down points for bungees, straps, cargo nets, etc.

» 2881447

POLARIS ACE™ '14-16, POLARIS ACE™ 900 XC '17-18, POLARIS ACE™ 900 SP '16, POLARIS ACE™ 570 SP '16-17, POLARIS ACE™ 570 '15-18, POLARIS ACE™ 500 '17-18



REAR ROPS EXTENSION

- Attaches to existing frame for additional protection
- Allows for mounting of accessory Spare Tire Holder (2881150)
- Works with Storage Box and Performance Rear Bumper (2881149)

» 2881154

POLARIS ACE™ 900 SP '16, POLARIS ACE™ 570 SP '16-17, POLARIS ACE™ 570 '15-18, POLARIS ACE™ 500 '17-18, POLARIS ACE™ '14-16

SPARE TIRE MOUNT

- Securely holds spare tire and wheel across top of rear ROPS cage

» 2881150

POLARIS ACE™ '14-16, POLARIS ACE™ 900 SP '16, POLARIS ACE™ 570 SP '16-17, POLARIS ACE™ 570 '15-18, POLARIS ACE™ 500 '17-18

Requires Rear ROPS Extension (2881154)
Wheel/Tire not included



SIDE BAGS

- Bag has a zippered compartment to securely hold cargo and a mesh outside pocket

• Sold as a set of 2

» 2880542

ALL POLARIS ACE™ MODELS WITHOUT DOORS



TRAIL BAG

- Securely holds cargo in four zippered compartments
- Adjustable Velcro™ straps secure bag to vehicle frame

» 2879705

POLARIS ACE™ '14-17



SPECIFIC NEEDS, SPECIFIC OILS

Polaris invests millions in engine development, and part of that investment is making sure its lubricants—critical to engine performance—are the right formula for your specific engine. The amount of testing data and engineering resources used in developing Polaris lubricants would overwhelm an aftermarket company. Therefore, the aftermarket must spec an oil to an industry-wide standard that must account for a variety of operating parameters.

PS-4 is designed specifically for Polaris 4-cycle engines and has high film strength and wear protection under extreme loads and temperatures. Exclusive anti-wear additives protect engine parts with extra rust and corrosion protection.

PS-4 FULL-SYNTHETIC OIL

• PS-4 is optimal for ambient operating temperatures of -40° C to 38° C

- » 1L • 2876244
- » 4L • 2876245
- » 61L • 2876247
- » 208L • 2876246
- » 1249L • 2878814

PS-4 OIL CHANGE KIT

• Contains the correct amount of oil for your vehicle and correct oil filter

- » 2202166 SINGLE 570, TWIN 600, TWIN 700, TWIN 800
- » 2879323 RANGER /RZR 900/1000
- » 2880913 POLARIS ACE /ETX 325
- » 2877473 330-500, SPORTSMAN 550/850/1000

ORV MAINTENANCE KIT

• Includes: 1.4 L AGL, 1 L Angle Drive Fluid, 473 ml Demand Drive Fluid, 89 ml tube of All-Season Grease

- » 2880425

PS-4 EXTREME-DUTY FULL-SYNTHETIC OIL

• PS-4 Extreme Duty is optimal for ambient operating temperatures of -18° C to 54° C

- » 1L • 2878920
- » 4L • 2878919
- » 61L • 2879003
- » 208L • 2879002
- » 1249L • 2879001

PS-4 EXTREME-DUTY OIL CHANGE KIT

• Contains the correct amount of oil for your vehicle and correct oil filter

- » 2879004 SINGLE 570, TWIN 600, TWIN 700, TWIN 800
- » 2878924 330-500, SPORTSMAN 550/850/1000
- » 2879324 RANGER /RZR 900/1000
- » 2881697 RZR TURBO

POLARIS® PS-4 VS THE COMPETITION

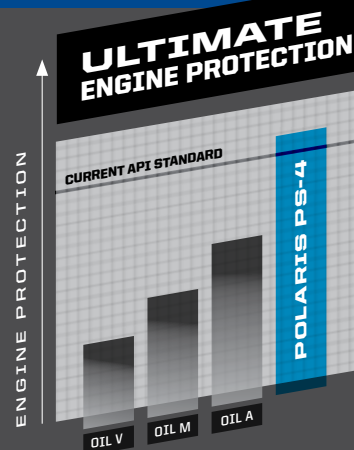

Polaris PS-4 oils exceed the latest industry protection standard as set by the API, while the competition uses standards from years ago. Our proprietary additives clean and protect critical engine parts under high operating temperatures.

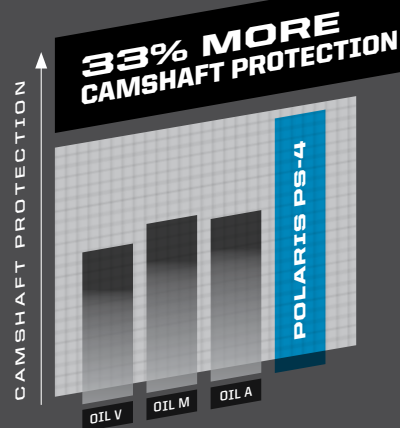

When tested against competitive oils, camshaft bearing races and lobes exhibit less wear when protected by Polaris PS-4 oil.

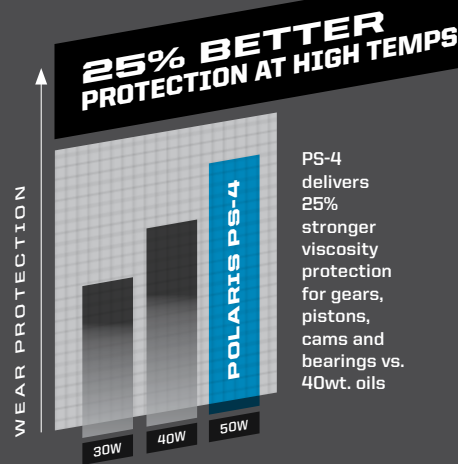

PS-4 delivers 25% stronger viscosity protection for gears, pistons, cams and bearings vs. 40wt. oils

WHY VISCOSITY MATTERS: Polaris engines are designed to operate using oils rated at a specific viscosity. Viscosity is the measure of an oil's resistance to flow and shear and a way to gauge an oil's "film strength", which is a critical component in preserving engine life when an oil is subject to high heat or heavy loads.

ENGINEERED TO MAXIMIZE THE LIFE OF YOUR RIDE

All Polaris fluids—from anti-freeze to brake fluid—are developed for your vehicle. Trust the only fluids perfectly engineered for your needs.

AGL

A proprietary blend of additives designed to optimize Polaris ORV transmission life. Extreme pressure additives protect gears, drive chain, and bearings from scoring and wear. Unlike typical gear case oils, AGL's unique viscosity range allows instant flow and film protection in extreme cold or high heat environments

- » 1L • 2878068
- » 4L • 2878069
- » 9.5L • 2878070
- » 280L • 2879594

Proper lubricant application and timing will ensure optimal vehicle performance. Please refer to your owner's manual for lubricant change interval schedules.

ANGLE DRIVE FLUID

ATV Angle Drive Fluid offers extreme pressure, anti-wear, and high viscosity film lubrication for maximum protection of Polaris ATV angle gear drive systems conditions

- Excellent corrosion protection for long component life under severe operating conditions
- » 1L • 2876160
- » 9.5L • 2872276

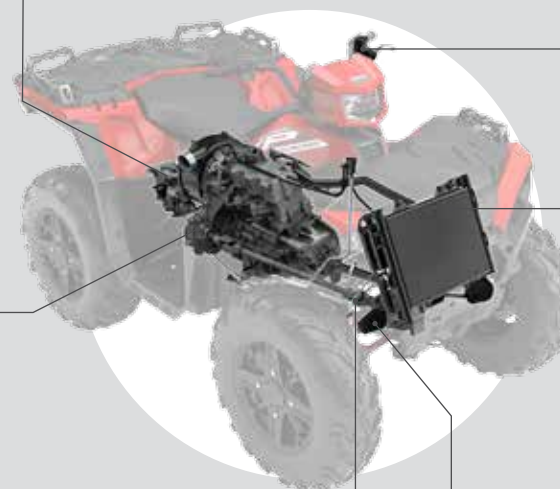

DOT 4 BRAKE FLUID

Polaris DOT 4 Brake Fluid is a high quality hydraulic brake fluid designed for use in Polaris hydraulic brakes. Superior high-temp characteristics plus anti-corrosive additives extend the life of brake system components and provide consistent, positive braking

- » 355 ml • 2872189

ANTI-FREEZE

Polaris Extended Life Coolant contains organic acid technologies to prevent corrosion on metal components, eliminate scaling, and maximize cooling system performance

- » 1L • 2880514
- » 4L • 2880513
- » 208L • 2880512

DEMAND DRIVE FLUID

Engineered specifically for Polaris ORV front drive systems. Provides positive 4WD engagement in extreme cold or high heat conditions. Unique friction additives protect internal components under heavy loads and promotes positive engagement

- » 1L • 2877922
- » 9.5L • 2877923
- » 208L • 2880512

U-JOINT GREASE

Polaris U-Joint Grease is a heavy-duty lubricant formulated with molybdenum disulfide to accept the high shock applications of Polaris ATV shaft drive universal joints

- » 89 ml • 2871515
- » 414 ml • 2871551

LUBE ACCESSORIES



GREASE GUN KIT

- » 2871312
- FITS 2871322 ALL-SEASON AND 2871322 U-JOINT 89 ml

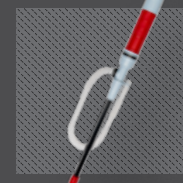

2D BATTERY-OPERATED SIPHON PUMP

- Liquid transfer pumps 4.7 L - 6 L/min suctioning power.
- Use with gas, water, oil, and other non-corrosive liquids
- » 2830513



FLEX SPOUT

- Convenient easy pour flex spout fits all Polaris quart, gallon, and 9 L bottles
- » 2871285



PUMP

- » 2870465
- ATTACHES TO 4- OR 9.5-LITER BOTTLE FOR EASY, NO-DRIP DISPENSING



PREMIUM GAS SHOCK OIL

- » 1L • 2870995
- » 9.5L • 2872279
- FOX REBUILDABLE SHOCKS



10WT GAS SHOCK OIL

- » 1L • 2874124
- WALKER EVANS REBUILDABLE SHOCKS



ANGLE DRIVE FLUID

- » 1L • 2876160
- » 9.5L • 2872276
- SPORTSMAN, RANGER, RZR ANGLE DRIVE GEAR CASE SYSTEMS



CHAIN LUBRICANT

- » 473 ml AEROSOL 2872348



ALL-SEASON GREASE TUBE

- » 89 ml 2871322
- » 414 ml 2871423



CARBON CLEAN

- Polaris Carbon Clean prevents ethanol corrosion, stabilizes fuel, cleans fuel injectors, piston ring lands, intake systems and combustion chambers. Helps maintain peak HP and improves fuel economy
- » 355 ml • 2881413



ADVANCED FUEL TREATMENT

- Advanced Fuel Treatment prevents ethanol corrosion and stabilizes fuel for up to 2 years. Dual-antioxidant formula protects against gum and varnish for easy starting
- » 355 ml • 2881416
- » 9.5L • 2881417



SCENTED ADVANCED FUEL TREATMENT

- 1 Liter pouch treats 19 Liter of fuel
- Scented formulas provide pleasant fragrance through the exhaust system
- Alcohol free: safe for all powerports applications
- » MINT • 2881418
- » STRAWBERRY • 2881419
- » UNSCENTED • 2881420
- » 25 - 1 L POUCHES OF EACH FORMULA • 2881421

FOR THE LIFE OF YOUR RIDE

THE KEY TO KEEPING YOUR POLARIS® OFF-ROAD VEHICLE PERFORMING

as well as the day you brought it home is proper maintenance. Items like belts, filters and batteries represent only a few of these critical items engineered specifically by Polaris®.

CHECK OUT OUR [PARTS FINDER ON POLARIS.COM](https://www.polaris.com) FOR EASY PARTS LOOK-UP, PARTS IDENTIFICATION, VIEWS OF ASSEMBLIES AND MORE!

POLARIS ENGINEERED™ DRIVE BELTS

Polaris Engineered™ belts deliver unmatched performance for your off-road vehicle. Our belts are developed and tested on all our engines for all environments and conditions. This ensures it doesn't merely fit your vehicle—it outperforms your expectations.



TESTED, PERFECTED

We test each belt on the intended vehicle – we don't try to make an existing belt "just work." The tolerances are tighter than aftermarket alternatives, meaning less heat for your engine, and you won't have to recalibrate your clutch in order to run at the engine's optimal RPM. Aftermarket belts fluctuate in and out of the optimal power band, which means more wear on your clutch and more maintenance needed to maintain power.

OUR INVESTMENT

We average **32,187 KM** of field testing and **thousands of dyno hours** on each engine to ensure the Polaris® drive belt on your machine gives you peak performance with each and every ride.

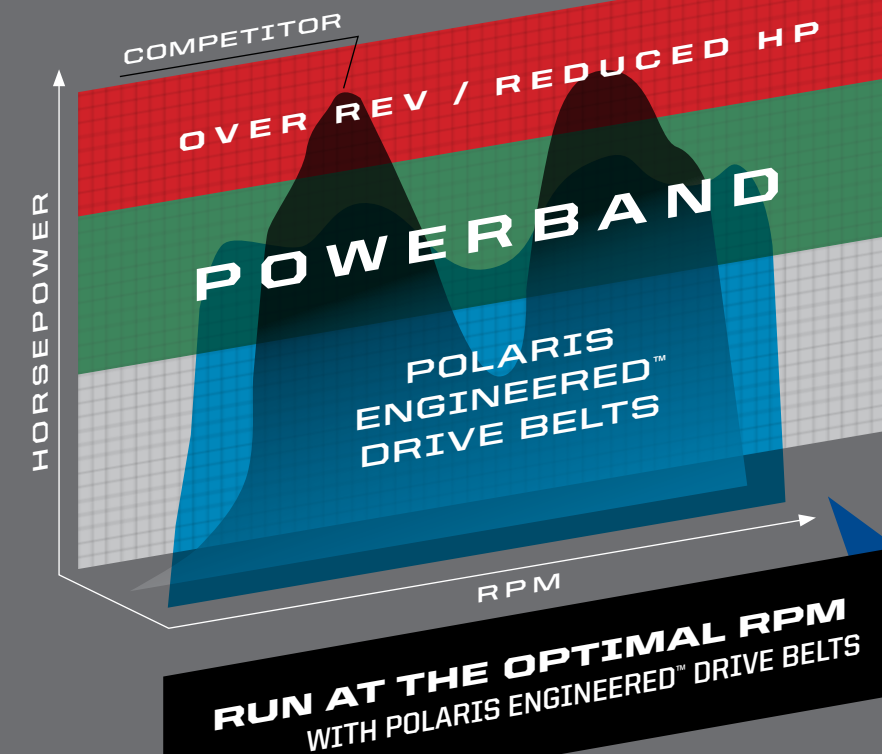

MAINTENANCE SCHEDULE

CHECK YOUR OWNER'S MANUAL FOR ADDITIONAL RECOMMENDED SERVICE ITEMS AND VEHICLE SPECIFIC TIMING

25 HRS/805 KM	100 HRS/1609 KM	150 HRS/2414 KM	200 HRS/3219 KM	350 HRS/5693 KM	500 HRS/8947 KM
BREAK-IN MAINTENANCE	12 MONTHS	18 MONTHS	24 MONTHS	30 MONTHS	36 MONTHS
ENGINE OIL: CHANGE GENERAL LUBRICATION: ALL FITTINGS, PIVOTS, CABLES, ETC. AIR FILTER: INSPECT & CLEAN REPLACE AS NEEDED	ENGINE OIL: CHANGE DRIVE BELT: INSPECT & ADJUST REPLACE AS NEEDED TRANSMISSION FLUID: CHANGE	ENGINE OIL: CHANGE BATTERY: TEST, CLEAN, & CHECK FLUID LEVEL REPLACE AS NEEDED DRIVE BELT: INSPECT & ADJUST REPLACE AS NEEDED TIRES: INSPECT CONDITION & PRESSURE	ENGINE OIL: CHANGE BRAKE PADS & FLUID: INSPECT & CLEAN REPLACE AS NEEDED SPARK PLUGS: INSPECT REPLACE AS NEEDED	ENGINE OIL: CHANGE BATTERY: TEST, CLEAN, & CHECK FLUID LEVEL REPLACE AS NEEDED DRIVE BELT: INSPECT & ADJUST REPLACE AS NEEDED GENERAL LUBRICATION: ALL FITTINGS, PIVOTS, CABLES, ETC.	ENGINE OIL: CHANGE AIR FILTER: INSPECT, CLEAN REPLACE AS NEEDED COOLANT: CHECK LEVEL REPLACE EVERY 2 YEARS GEARCASES: CHECK OIL LEVEL

POLARIS POWER®

POWERFUL, PORTABLE, DURABLE. These digital inverter generators are built to match your outdoor lifestyle, and are tested to the same rigorous standards as every Polaris® product. The 1000-watt generator is best for running a single device with low wattage requirements. The 2000-watt generator runs multiple devices with added surge protection and start-up wattage. The 3000-watt generator handles high-output needs and runs multiple devices. It also includes electric start for ease of use when needed.

WHICH GENERATOR FITS YOUR NEEDS?

- 1 START** by adding up the running watts of everything you might power at the same time. (use the chart on the left)
- 2 NEXT**, pick the device with the highest running watts, and add its starting watts to the previous total.
- 3 NOW** you have the total amount of watts you need from your generator. Select a generator with a slightly higher wattage.

	Startup Wattage	Running Wattage
140 cm LCD TV	0	150
CROCK POT	0	200
RADIO	0	50-200
LAPTOP	0	200-250
625W MICROWAVE	0	625
FRIDGE OR FREEZER	700	700
COFFEE MAKER	1300	800
SUMP PUMP: ½ HP	1300	800
BLENDER	1000	1000
ELECTRICAL GRIDDLE	0	1500
18.4 cm CIRCULAR SAW	1700	1400
AIR CONDITIONER	1500	1500



POLARIS POWER® INVERTER GENERATORS

- » 1000 WATT • P136DGNANA
- » 2000 WATT • P136DGBNA
- » 3000 WATT • P136DGCNA



POLARIS POWER® CABLE KIT

- Use a parallel cable kit to easily connect two Polaris Power® generators together to increase the total power available to a load

» 3410281



POLARIS POWER® TIE-DOWN LEADS

- Secure your Polaris Power® Generator by inserting the Lock & Ride® Tie Down Leads into the handle and running a strap across to tie down the generator
- Secures Lock & Ride® accepting gear
- Safely provides a point for 2.5 cm wide tie down strap

» 2880959



POLARIS POWER® COLD WEATHER KIT

- Ensure smooth running of your Polaris® Generator in below -18° C temperatures
- Prevents ice blockage in the crankcase breather tube, which may lead to operational issues including oil leakage
- Installation required, no need to disconnect for warm weather operation
- Exclusively designed for use with Polaris® P1000i & P2000i inverter generators

» 2881433



POLARIS POWER® GENERATOR OIL

Corrosion inhibitors protect against rust and oxidation during long-term storage.

» 1 LITER • 2879383

POLARIS POWER® GENERATOR STORAGE COVERS

- Keep your generator looking like new with a strong, durable cover that is resistant to mold, mildew, tears and abrasions

» 1000 WATT COVER • 2686441

» 3000 WATT COVER • 2686443

» 2000 WATT COVER • 2686442



POLARIS® FLEX JUMPSTARTER

12,000 mAh capacity. Two 5V/2.1A USB outputs, 200-lumen flashlight and a digital battery-life monitor. Includes storage case, smart jumper cables, car charger, wall charger, and user guide. 1-year limited warranty.

» 2830495



Never let a dead vehicle battery slow you down again. The Polaris® Flex Jump-starter is a compact solution that provides the power to get your ride started. Flex is small enough to be stored in your glovebox, and holds its charge so you can count on it when it's needed. In addition to being able to jumpstart ATVs, ORVs, snowmobiles, motorcycles, cars, & trucks, Flex can also charge any USB capable device through its dual USB outlets. Flex has the ability to jumpstart up to a 6.4L engine.

BatteryMINDER®

Make sure your vehicle's battery is properly maintained and ready for when you need it the most with a BatteryMINDER®. A tired battery is waiting for the perfect time to ruin your day, so make sure it gets charged and cycled properly. Easily one of the most essential pieces of equipment every garage needs.



BATTERYMINDER® 1510 1.5-AMP

- Recovers weak batteries
- Ambient temperature sensor with wide operating range ensures the battery will never be overcharged or undercharged regardless of temperature extremes
- Extends battery life up to four times when compared to new batteries not being properly charged or maintained over their lifetime
- Automatic full-time high frequency (not high voltage) pulse type desulfation
- Reverse polarity, short circuit, and over temperature protection

» 2830404

BATTERYMINDER® 2012 AGM 2-AMP

- Designed for High-Performance Specialty AGM Sealed Batteries
- Guaranteed to never overcharge, regardless of how long connected
- Temperature compensation ensures proper charge in hot or cold environments
- Ambient temperature sensor with wide operating range ensures the battery will never be overcharged or undercharged regardless of temperature extremes
- Maximizes battery life and capacity, reconditions weak batteries

» 2830438

BATTERYMINDER® 1.5 AMP CONVERTIBLE

- BatteryMINDER® 1.5 AMP On-board or Benchtop Charger/Maintainer
- Complete with two mounting brackets for multiple vehicles/locations, fully-insulated battery clips, and ring terminal-assembly for permanent direct-to-battery attachment.
- Charges, Maintains, Recovers 12-volt batteries
- Maintains up to four batteries at a time
- Attaches to battery while in vehicle or for use on benchtop
- Guaranteed to never under- or overcharge
- Recovers and reconditions deeply discharged batteries automatically, using high-frequency pulse type desulfation circuitry
- Can extend battery life up to four times

» 2830511

BATTERYMINDER® EZ CONNECT

- Allows for quick and easy connecting and disconnecting of your BatteryMINDER, includes a set of ring terminals

» 2830411

BATTERYMINDER® 30 cm CABLE

- Made with heavy-duty 30 cm black zip cord featuring automotive SAE bullet connectors

» 2830410

BATTERYMINDER® SPLITTER

- A simple, safe, and affordable way to connect two batteries simultaneously for easy battery maintenance, cap includes a set of ring terminals

» 2830409

BATTERYMINDER® RING TERMINAL

- Features 61 cm long 18-gauge wire
- Plug has standard .8 cm negative and .95 cm positive terminals
- Replaceable 15-am in-line fuse for circuit protection
- Uses SAE quick connector and cap

» 2830437

TOOL STORAGE SOLUTIONS

1

Give your tools a dedicated spot with a properly sized rolling base. Extra-deep drawers are great for storing power tools and bulky items.

CHOOSE YOUR BASE

Raise-and-release drawer pulls keep drawers secure when moving

Drawers use roller-bearing glides

Full-width wrap-around aluminum drawer pulls



POLARIS® 76 cm 5-DRAWER ROLLER CABINET

• 78 cm W × 104 cm H × 52 cm D
» TEXTURED FINISH 2830406*

Two extra-deep drawers allow storage of large and bulky tools



POLARIS® 104 cm 11-DRAWER ROLLER CABINET

• 104 cm W × 105 cm H × 46 cm D
» TEXTURED FINISH 2830408*
» HIGH-GLOSS FINISH 2830451*



POLARIS® 183 cm 19-DRAWER ROLLER CABINET

• 183 cm W × 119 cm H × 64 cm D
» HIGH-GLOSS FINISH 2830492*

Three extra-long drawers provide storage for tools of all shapes and sizes

2

Polaris® offers two types of tops: Portable and permanent.

CHOOSE YOUR TOP



POLARIS® 76 cm PORTABLE WORKSTATION
78 cm W × 52 cm H × 44 cm D
» TEXTURED FINISH 2830405*



POLARIS® 104 cm PORTABLE WORKSTATION
• 104 cm W × 55 cm H × 44 cm D
» TEXTURED FINISH 2830407*



POLARIS® 30 cm STANDARD TOP CHEST
• 103 cm W × 52 cm H × 50 cm D
» HIGH-GLOSS FINISH* 2830450*



POLARIS® 183 cm STAINLESS STEEL TOP
• 183 cm W × 1.3 cm H × 64 cm D
» 2830496

* Tools not included

DON'T FORGET THE FINISHING TOUCHES

3

Complete the organizing with a strategically placed caddy.

UPGRADE



POLARIS POWER® TOOL CADDY
• Hangs from fence rail of roller tool cabinets
» SILVER • 2830430*



POLARIS® HAND TOOL CADDY
» SILVER • 2830431*



POLARIS® BADGES
» RANGER® • 2830413
» RZR® NOT SHOWN 2830412

FINISH YOUR GARAGE



POLARIS® MAGNETIC PARTS TRAY
» SILVER • 2830432

POLARIS® 84 cm TELESCOPIC MAGNET
» BLACK • 2830435



POLARIS® 31 cm HI-TORQUE RATCHETING DRIVER
» BLACK / BLUE • 2830434



POLARIS® LED POCKET FLASHLIGHT
» BLACK • 2830436



POLARIS® HEAVY-DUTY SCRUBBER WIPES
» 90 COUNT 2830441



POLARIS® SHOP TOWELS
» 200 COUNT SHOP TOWEL ROLL WITH DISPENSER 2830402
» 200 COUNT REFILL 2830403
» 64 COUNT SHOP TOWEL REFILL • 2830440

NEW



ROLL IT WHERE YOU NEED IT

Inspired by the carts that top racing teams use, this cart offers the best in storage and portability. Whether in the shop or out in the field, your tools go where you need them the most.

TOOL CART

- Rolling design allows for maximum portability
 - Multiple-depth drawers securely hold hand tools, power tools, and more
 - Large tires for performance in all types of terrain
 - Take your tools where you need them easily and securely
- » 79 CM WIDE X 48.36 CM DEEP X 100 CM HIGH 2830512

ELEVATE YOUR WORK



POLARIS® VEHICLE LIFT

- Get fast, easy access to the underside of your vehicle
- Manual and pneumatic operation available
- Raises vehicle up to 81 cm to make repairs & maintenance faster and easier
- Dual-locking safety latch for added safety

» 1205 LB (567 KG)
2830424

» 2300 LB (1043 KG)
2830425

POLARIS® VEHICLE LIFT ATTACHMENTS

- » RZR / RANGER 2830428
- » ATV/POLARIS ACE® 2830427
- » SNOWMOBILE 2830426



POLARIS® X3 CREEPER

- Three positions: flat, 45-degree angle, or seated work stool
- Helps you perform any repair with ease
- Stay dry and warm away from cold, wet cement floors
- Easily stores away when not in use

» BLACK • 2830429

PREMIUM TIRE SEALANT

- Instantly seals and repairs rim, bead leaks, and punctures up to .6 cm on standard tires, and 1.9 cm on heavy ply tires
- Helps maintain air pressure for the life of the tire
- Helps seal the tire bead against the wheel
- 100% water soluble for easy cleanup.
- Will not rust, corrode, or pit wheels
- Creates permanent repair
- Remains fluid and effective in temperatures down to -43° C
- Easily installed through existing tire valve stem with valve core removed

» 946 ml • 2830484
» 4 LITERS • 2830485
» 19 LITERS • 2830486

» 19 LITER PUMP • 2830487
» 208 LITER • 2830489
» 1041 LITER • 2830488



HOW IT WORKS

Tire sealant remains liquefied inside your tire until some sort of leak develops in the tire or wheel.

Once a leak occurs, the tire sealant rushes out of the tire and quickly creates a permanent solid plug.

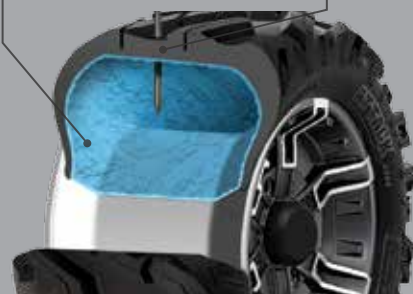

The sealant creates a permanent solid plug and maintains the pressure of the tire so you can continue your ride.

KEEP IT CLEAN

PRE-TREAT

MUD SHIELD® PRE-TREATMENT

- Inhibits the adhesion of dirt, mud, and snow, making cleaning your vehicle faster and easier.
- » 473 ml AEROSOL • 830208

NEVER RUST SPRAY®

- Synthetic formula highly resistant to water protects against rust and corrosion while lubricating metal surfaces.
- » 473 ml AEROSOL • 2830209

CLEAN

XP WASH®

- Foaming, highly-concentrated wash easily removes the most stubborn and intense dirt build-up.
- » 946 ml

XP SPRAY WASH®

- Effortless biodegradable, high-performance wash ideal for removing dirt, oils and carbon—simply spray on, spray off and go.
- » 946 ml

ALL-PURPOSE CLEANER

- Professional grade, non-streak, foam formula cuts through grease dirt and film leaving an invisible, dirt-resistant barrier for long-lasting results.
- » 473 ml • 2830205

GLASS CLEANER

- Heavy-duty foam non-streak formula cuts through grease, dirt, dried bugs and film leaving a crystal clear dirt-resistant barrier for long-lasting results.
- » 473 ml

SHINE

POLARIS® POLISH

- Easy protection and shine—spray on, wipe off, and go. For ideal use on painted and plastic surfaces. Contains carnauba wax.
- » 473 ml

INSTANT SHINE & DETAILER

- Spray and wipe formula—cleans, polishes, and protects plastic and painted surfaces.
- » 473 ml • 2830204

TRAILERING



RampPro BY CALIBER®

- Designed for ATVs and UTVs up to 127 cm wide
- Integrated grip glides for ultimate traction
- Sides fold for compact transportation
- » 132.1 cm x 228.6 cm 2883005

ALUMINUM ARCHED LOADING RAMPS

- » 2,000 LB (907 KG) CAPACITY
193 cm x 30 cm • 2875384
- » 3,000 LB (1360 KG) CAPACITY
223.5 cm x 30.5 cm • 2875386

LIGHTWEIGHT TRI-FOLD RAMPS

- Ramp folds up for transport
- Capacity for up to 1,500 lb (680.7 kg)
- Safety straps included
- » 183 cm x 130 cm • 2875385
- » 208 cm x 130 cm • 2875860

FOLDING ALUMINUM ARCHED RAMPS

- Ramp folds up for transport
- Capacity up to 1,500 lb (680.7 kg)
- Safety straps included
- » 224 cm x 30 cm • 2875387

RECEIVER HITCH

- » 5 Cm RECEIVER • 2875320
- » FRONT HITCH RECEIVER • 2878846



TRAILER BALL 1.9 cm SHANK

- » 5.4 cm • 2877602
- » 5 cm • 2877603



TIE-DOWN RATCHET STRAPS

- 3.8 cm shockstrap ratchet with safety strap
- » 2859047-01 • RED
- » 2859047-02 • BLACK



TRAILERING COVERS BY POLARIS®

- » 2876614
ALL SPORTSMAN® EXCEPT 300/400, X2, TOURING
- » 2877999
ALL SPORTSMAN® TOURING



- » 2877998
SPORTSMAN® X2
- » 2880056
ALL POLARIS ACE® EXCEPT 900 XC



SHOP CLEANERS

ALL-PURPOSE CLEANER PLUS

- Professional-grade formula removes built-up stains from shop floors, work benches, and other hard surfaces. VOC-free, environmentally-friendly, and biodegradable.

» 4 L • 2830414 » 19 L • 2830416

VEHICLE & EQUIPMENT WASH

- Concentrated professional grade formula powers through vehicle buildup, dirt, and grease with a spot-free rinse. Treat up to 32 gals. Biodegradable.

» 4 L • 2830417 » 19 L • 2830422

HD CLEANER & DEGREASER

- Professional-grade, biodegradable, high-foaming formula dissolves and removes tough stains and soils.

» 4 L • 2830418 » 19 L • 2830420

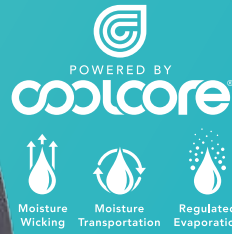

TENACITY HELMET

- Injection-molded plastic
- 1450 grams
- 14 intake and 8 exhaust vents for airflow
- DOT and ECE Certified
- » 2868624 • PINK XS-2XL

COOLING SHIRTS

- 100% Poly, chemical free patented fabric from CoolCore®
- Moisture wicking to keep you dry
- Moisture transportation to keep you cool
- UPF 45+
- » MEN'S • 2868753 GRAY/ORANGE • S-3XL
- » WOMEN'S • 2868755 GRAY/PINK • S-3XL

509° KINGPIN GOGGLE

- Quick-change lens technology
- Contoured triple layer foam
- Premium anti-fog & anti-scratch coatings
- » 2868668 • ORANGE ONE SIZE

509° ALTITUDE CARBON HELMET

- Carbon fiber shell
- 1100 grams
- Fidlock magnet closure
- 8 intake/exhaust vents for airflow
- DOT and ECE2205 Certified
- » 2867814 • BLACK MATTE S-4XL

MEN'S SOFTSHELL JACKET

- Lined with 280 grams of fleece for warmth
- Removable hood
- Pit zips for venting
- » 2868514 • BLACK/ORANGE S-3XL

STAY WARM

509° ALTITUDE HELMET

- Thermo Poly alloy shell
- 1260 grams
- 8 intake/exhaust vents for airflow
- DOT and ECE2205 Certified
- » 2868539 • LIME S-4XL

ORV RIDING JERSEY

- 100% Poly
- Side mesh panels for venting
- » 2868711 • BLUE/LIME S-3XL

ORV RIDING GLOVES

- Lycra panels provide flexibility in grip
- Soft flex graphics on knuckles for protection
- Lightly padded palm for comfort
- Machine washable
- » 2868712 • BLUE/LIME S-3XL



FORCE HELMET

- Injection molded plastic
- 1380 grams
- 11 intake and 4 exhaust vents for airflow
- DOT Certified
- » 2868839 • BLUE XS-2XL

MID LAYERS

- Flexible pill resistant poly fleece
- Ideal for layering or on it's own
- » WOMEN'S • 2868516 BLACK • S-3XL
- » MEN'S • 2868512 BLACK • S-3XL



KEEP YOUR COOL



CAMO TRUCKER CAP

» 2868750 • CAMO • ONE SIZE

HUNTER HOODIE

» MEN'S • 2868716 • OLIVE HEATHER S-3XL
 » WOMEN'S • 2868721 NOT SHOWN OLIVE HEATHER • S-3XL

CAMO HOODIE

» WOMEN'S • 2867898 • CAMO S-3XL
 » MEN'S • 2867879 NOT SHOWN CAMO • S-3XL



'MERICA RETRO CAP

» 2867757 • BLUE/RED • ONE SIZE

MEN'S RETRO TEE

» 2868571 • GRAY • S-3XL

WOMEN'S RETRO CAP

» 2868617 • GRAY • ONE SIZE

WOMEN'S 3/4 BASEBALL TEE

» 2868584 • GRAY/PINK • S-3XL



MEN'S RETRO LOGO HOODIE

» 2868577 • GRAY • S-3XL



MEN'S ROSEAU HOODIE

» 2868576 • OLIVE S-3XL

WOMEN'S RETRO HOODIE

» 2868592 • BERRY S-3XL



WOMEN'S ASYMMETRICAL HOODIE

» 2868596 • BERRY S-3XL

WOMEN'S V-NECK SCRIPT TEE

» 2868588 • GRAY S-3XL



HEX CAP

» 2867766 • BLACK • ONE SIZE

MEN'S EST TEE

» 2868570 • BLACK • S-3XL

MEN'S HEX TEE

» 2868568 • NAVY • S-3XL

WOMEN'S SCRIPT CREW SWEATSHIRT

» 2868603 • CHARCOAL • S-2XL



WOMEN'S FULL ZIP RETRO HOODIE

» 2868595 • CHARCOAL HEATHER S-3XL



REVERSIBLE CAMO BEANIE

» 2867756 • ORANGE/CAMO ONE SIZE

MEN'S CAMO TEE

» 2868757 • CAMO S-3XL

MEN'S TEXTILE RIDING JACKET

» 2867875 • COFFEE S-3XL



CAMO WATER BOTTLE

» 2867962

CAMO COFFEE TRAVEL MUG

» 2867961

CAMO BOTTLE KOOZIE

» 2867964

CAMO CAN KOOZIE

» 2867963

CAMO STEERING WHEEL COVER

» 2868663

CAMO BOTTLE OPENER NOT SHOWN

» 2867965



RETRO CLOCK

» 2868662

PINT GLASS SET OF 2

» 2866265

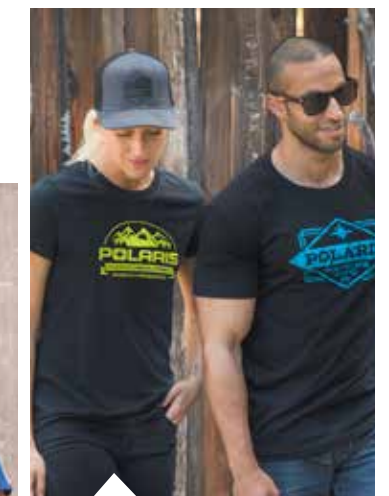
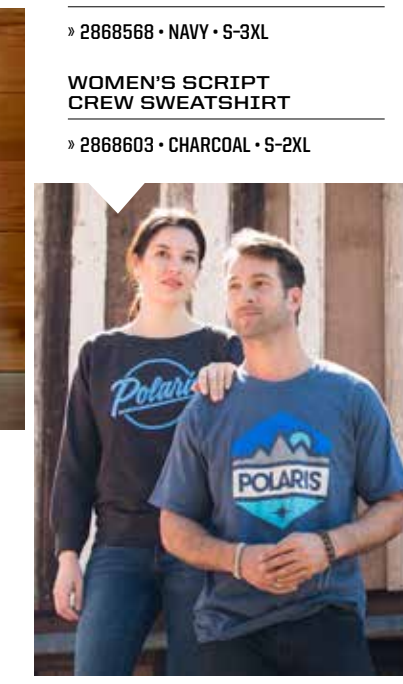

WOMEN'S ROSEAU TEE

» 2868586 • BLACK • S-3XL

MEN'S MFG CO TEE

» 2868776 • BLACK • S-3XL