

INTERNATIONAL VERSION



POLARIS[®]

RANGER[®]

2018

ACCESSORIES + APPAREL

POLARIS
RANGER

HARDEST
WORKING.

SMOOTHEST
RIDING.

**THERE IS A
RANGER® FOR YOU**

On the farm, ranch, hunt or the trail, **RANGER®** fits your needs and lifestyle. Whether it's just you, or your whole crew, **RANGER®** has seating options for up to six people with no compromise in cargo bed capacity or payload.

**INDUSTRY LEADER
IN UTILITY SxS**

Every **RANGER®** we engineer is validated through decades of industry-leading innovation that's driven by customer-influenced design and quality that puts us ahead of the rest.

**ULTIMATE
VERSATILITY**

Industry-exclusive accessories like the new **RANGER Pro Shield™** Cab System and easy-to-install **Lock & Ride™** accessories mean you can quickly change your **RANGER®** from a utility work horse to your companion on the hunt or trail.

**BUILT TO
GET MORE DONE**

RANGER® offers powerful and efficient ProStar® engine options with class-leading towing and payload capability. With its best-in-class ground clearance and legendary ride characteristics, it works hard when you need it most - in any scenario.

FIND YOUR MODEL



RANGER® 570 FULL-SIZE



RANGER XP® 900 EPS



RANGER XP® 1000 EPS



RANGER XP® 1000 EPS
NORTHSTAR HVAC EDITION
FITMENT CODE: HVAC



RANGER XP® 1000 EPS
HIGH LIFTER EDITION
FITMENT CODE: HL



RANGER® DIESEL



RANGER CREW® 570-6



RANGER CREW®
XP 900 EPS



RANGER CREW®
XP 1000 EPS



RANGER® DIESEL CREW

MID-SIZE



RANGER® 500



RANGER® 570 EPS



RANGER® EV



RANGER® EV LI-ION



RANGER CREW®
570-4 EPS

COMMON ACCESSORIES



POLARIS® PRO HD SERIES WINCHES



PRO ARMOR® WHEELS & TIRES



GLACIER® PLOW BLADES - POLY

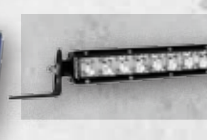

NEW RIGID® LIGHTING

- 02 POLARIS ENGINEERED™
- 06 FULL-SIZE
- 08 CAB SYSTEMS
- 18 ROOFS
- 20 WINDSHIELDS & REAR PANELS
- 24 DOORS
- 28 CAB COMFORT
- 30 AUDIO
- 36 STORAGE
- 39 COOLERS
- 40 HUNT
- 44 BUMPERS & GUARDS
- 46 570 FULL-SIZE ACCESSORIES

- 48 MID-SIZE
- 52 CAB SYSTEM
- 56 ROOFS
- 57 DOORS
- 58 WINDSHIELDS & REAR PANELS
- 62 CAB COMFORT
- 63 BUMPERS & GUARDS
- 64 STORAGE
- 66 HUNT
- 68 COOLERS

- 69 WINCHES
- 72 PLOWS
- 78 WHEELS & TIRES
- 84 LIGHTING
- 88 OIL/LUBRICANTS/GARAGE
- 90 GARAGE
- 98 APPAREL

ENGINEERED WITH EXCEPTIONAL CRAFTSMANSHIP

Ensuring Polaris Engineered Accessories™ fit and work in sync with your machine is the most critical phase of testing and validation. With seamless integration, you can trust that any Polaris® accessory you install will enhance your interaction beyond your expectations.

POLARIS®

ENGINEERED PARTS
ACCESSORIES & APPAREL

POLARIS ENGINEERED™



DESIGNED

Only Polaris Engineered Accessories™ are conceived, designed and fabricated in lockstep with the Polaris RANGER® development process. As the vehicle progresses from concept to production, so do the accessories. This ensures a perfect fit and optimal performance.



TESTED

The Polaris® testing process is rigorous and unforgiving. We put vehicle and accessories through extreme conditions both in the lab and out in the field - in all environments and in locations spanning the continent. If it doesn't pass our standards, it's not ready for your Polaris® vehicle. This means only the best accessories make it to production.

TRUSTED

Developing the best, most premium accessories in the industry is our passion. Polaris® combines decades of industry-leading experience, innovation and off-road expertise. You can have confidence in your Polaris Engineered Accessories™, because we know the lifestyle and live it every day.

POLARIS® PARTNERS WITH THE BEST

We choose our partners carefully, selecting only the best in off-road. Every accessory is rigorously tested and validated by Polaris® standards, to ensure seamless integration and performance.



KOLPIN®
OUTDOORS

HUNTING p. 42



PRO ARMOR®



WHEELS & TIRES p. 78 | LIGHTS p. 85



RIGID

LIGHTS p. 84



MBQUART®

AUDIO p. 30

ENGINEERED FOR MORE

Leaders never stop pushing for more. An unrelenting pursuit of innovation, performance and unyielding dependability defines *RANGER*® as the Hardest Working, Smoothest Riding,® utility vehicle in the world. Developed and tested along with the 2018 *RANGER XP*® 1000, Polaris Engineered Accessories™ are designed for seamless integration and simple installation, so riders can leverage the full capabilities of the machine and maximize efficiencies to get more done, year-round.

PRO PRO HEAVY DUTY SERIES

WINCHES

INTEGRATED WINCH

Designated mounting points and pre-wired contactors ensure a perfect fit and the strongest place to attach the Polaris Engineered™ winch - the most dependable winch for your *RANGER*®. With wiring built right into the vehicle, we made this the easiest *RANGER*® winch ever made to install.

GLACIER® PLOW SYSTEM

INTEGRATED PLOW MOUNT

The attachment points for the best-in-class Polaris Glacier® Plow System are integrated right at the factory and feature an innovative drive-up and go installation process.

RANGER PRO SHIELD™ CAB SYSTEM

THE TIGHTEST SEALING CAB

With the profile channels engineered into the roll cage, body plastics molded to seal and cab accessories designed to keep the elements out, the *RANGER* Pro Shield™ Cab System offers an industry-leading, 3x better dust seal.

LOCK & RIDE

CARGO BOX VERSATILITY

Lock & Ride® mounting locations allow for limitless customization to let you work the way you want.

POLARIS PULSE™ Electrical System

PLUG & PLAY ELECTRICAL

A revolution in electrical accessory integration, the Polaris Pulse™ Electrical System allows for a simple plug & play approach for adding power to Polaris Engineered Accessories™.





CAB SYSTEM p. 8



AUDIO p. 30

FULL-SIZE

WORK HARD AND GET IT DONE with Polaris Engineered Accessories™ for your *RANGER*®. Start with the ultimate in all-season performance and comfort with the best cab components in the industry. Then add in lighting, wheels, tires, a winch, Glacier® plows and more. Find everything you need to outfit your trusted partner for the task at hand.



TIRES p. 78



WINCHES p. 69



LIGHTING p. 84



PLOWS p. 72

BUILD ALL-TERRAIN AND
ALL-SEASON PROTECTION
 THAT NEVER QUILTS

POLARIS® CAB SYSTEMS ARE DESIGNED WITH YOUR RANGER® to be the tightest fitting, tightest sealing cab in the industry. With thousands of ways to configure, there is a cab for every RANGER® to help you gain all-season protection, comfort and confidence for the field, the hunt or beyond.



Look for RANGER Pro Shield® Cab System components for ultimate protection and comfort.



ROOFS P. 18-19



WINDSHIELDS P. 20-23



REAR PANELS P. 20-23



DOORS P. 24-27



INTRODUCING RANGER PRO SHIELD™ CAB SYSTEM

Designed and engineered alongside the new RANGER XP® 1000, the RANGER Pro Shield™ Cab System exceeds expectations. Each Polaris Engineered™ cab component has two decades of innovation built into it, and offers the industry's tightest seal in every environment. Its evolutionary fit and finish complement Lock & Ride® modularity to provide a superior experience every day, year-round, no matter the weather.



Only cab components with the RANGER Pro Shield™ nameplate assemble to provide the industry-leading best dust, water and noise reduction.

SUPERIOR INTEGRATION

A FRAME DESIGNED FOR A CAB

All RANGER® cab components fit perfectly to the contours of the RANGER XP® 1000 profile tube cab frame, floor and body panels, allowing for a 360° gasket seal, seamless fit and installation providing unprecedented protection from the elements.

360° GASKET SEALS

Gaskets lining the perimeter of each RANGER Pro Shield™ cab component seal out drafts, dust and moisture from the interior.

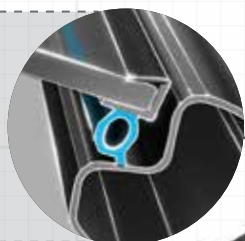

LOCK & RIDE®

With exclusive Lock & Ride® easy-on, easy-off installation technology, add or remove cab components quickly and efficiently without tools.

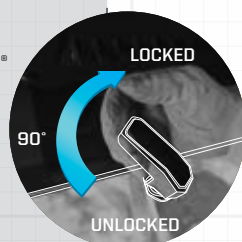

INDUSTRY'S TIGHTEST SEAL

3X BETTER DUST SEAL

AVAILABLE EXCLUSIVELY FOR
RANGER XP® 1000

TESTED.

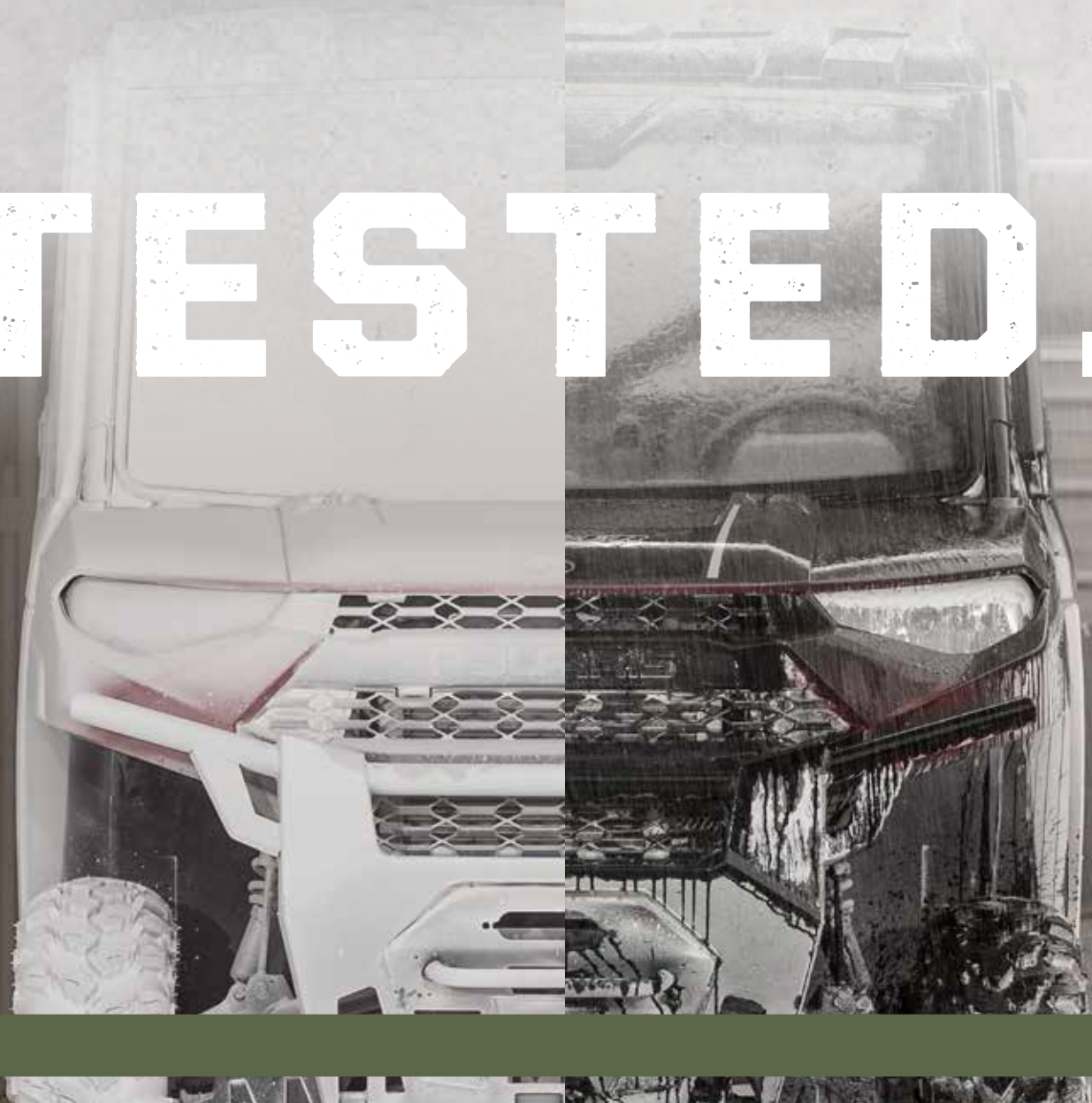

PROVEN.

MIL-STD 810G 510.5 DUST TEST

3x BETTER DUST SEAL

MIL-STD 810G 506.5 RAIN TEST

1.5x BETTER RAIN SEAL

WIND TUNNEL TEST

2x BETTER NOISE REDUCTION



YEAR ROUND COMFORT WITH THE

RANGER PRO SHIELD™ CAB SYSTEM

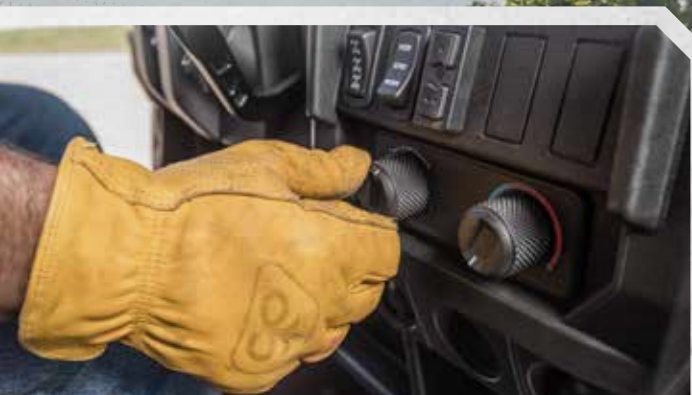

RANGER PRO SHIELD™ CAB COMPONENTS on the **RANGER XP® 1000** represent the best of the best, and keep you going regardless of the weather. Different venting options, from windshields to doors to rear panels, keep you comfortable all day long, in any season, because there are no vacation days when there's work to be done.

FEATURED RANGER PRO SHIELD™ CAB COMPONENTS

- A. TIP-OUT WINDSHIELD - GLASS 2882874
- B. LOCK & RIDE PREMIUM ROOF - POLY 2882912
- C. LOCK & RIDE REAR PANEL - SLIDING GLASS 2879015
- D. CRANK WINDOW DOORS - POLY 2882561
- E. EXTERIOR DOOR ACCENT PANELS - SUNSET RED METALLIC 2882870-520

CLEAR LINES OF SIGHT

WHEN YOU NEED IT MOST



KEEP GOING FROM DAWN 'TIL DONE, IN ANY SEASON with a Polaris *RANGER* Cab. Outfit your machine with cab components and stay comfortable and out of the elements. From *RANGER* ClearView Doors to a Lock & Ride Flip-Down Windshield in Hard Coat Poly, get the visibility necessary to tackle any task in any season.

FEATURED *RANGER* CAB COMPONENTS

- A. **LOCK & RIDE** FLIP-DOWN WINDSHIELD - HARD COAT POLY 2881919
- B. HD ROOF - STEEL 2879881

- C. **LOCK & RIDE** REAR PANEL - POLY 2879134
- D. *RANGER* CLEARVIEW DOORS 2882188

OVERHEAD PROTECTION

TO SHIELD AGAINST DRIVING RAIN OR THE BLISTERING SUN, a roof is the first must-have of the Polaris Engineered™ cab components. Choose from poly, steel or canvas, and get on your way with protective peace of mind.

POLY

Lightweight, durable and impact-resistant. A poly roof can take the abuse of a tough trail and still protect.

ROOF LINERS

Get a touch of premium comfort, reduce cab noise and hide wiring. Add a roof liner to your sport roof for added fit and finish.



SEE AUDIO OPTIONS ON P. 30

PREMIUM & SPORT ROOF FEATURES

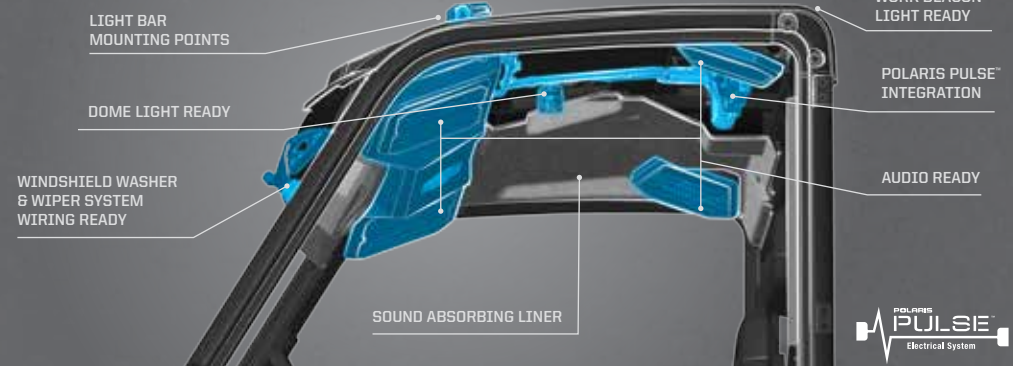

LOCK & RIDE

PREMIUM ROOF - POLY **NEW**

- » BLACK • 2882912
 - » CAMO • 2882913
- XP 900 '13-18, XP 570 '15-16, XP 1000 '18, XP 1000 '17, XP 1000 HL '18, DIESEL '15-17
* INCLUDES ROOF LINER



LOCK & RIDE

SPORT ROOF - POLY **NEW TOP SELLER**

- » BLACK • 2882911
- XP 900 '13-18, XP 570 '15-16, XP 1000 '18, XP 1000 '17, XP 1000 HL '18, DIESEL '15-17



PREMIUM ROOF LINER **NEW**

- » 2882914
- XP 900 '13-18, XP 570 '15-16, XP 1000 '18, XP 1000 '17, XP 1000 HL '18, DIESEL '15-17
* WORKS WITH 2882911, 2882912, 2882913

LOCK & RIDE

PREMIUM ROOF CREW - POLY

- » CAMO PREMIUM • 2883243
- CREW XP 900 '15-18, CREW XP 570 '15-16, CREW XP 1000 '17-18, CREW DIESEL '16-17
* ROOF LINER INCLUDED WITH CAMO



LOCK & RIDE

SPORT ROOF CREW - POLY **TOP SELLER**

- » BLACK • 2883242
- CREW XP 900 '15-18, CREW XP 570 '15-16, CREW XP 1000 '17-18, CREW DIESEL '16-17



PREMIUM ROOF CREW LINER

- » 2882175
- CREW XP 900 '14-18, CREW XP 570 '15-16, CREW XP 1000 '17-18, CREW DIESEL '16-17



PLUG & PLAY

ADD POWER TO YOUR ROOF - P. 86
ONLY ON XP 1000

STEEL

For the ultimate in strength and protection.

CANVAS

Lightweight and easy to clean. Canvas roofs install simply and store easily.

HD ROOF - STEEL

- » 2879881
- XP 900 '13-18, XP 570 '15-16, XP 1000 '18, XP 1000 '17, XP 1000 HL '18, DIESEL '14-17, CREW XP 1000 '17-18
* ROOF LINER INCLUDED

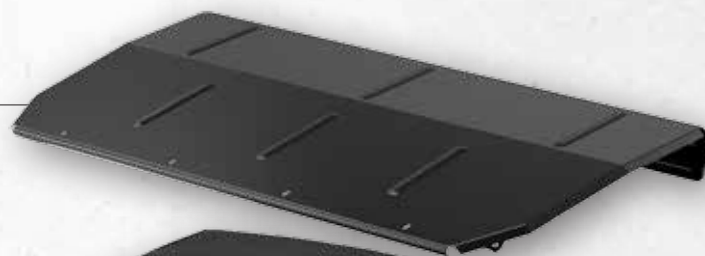

HD ROOF CREW - STEEL

- » 2880334
- CREW XP 900 '14-18, CREW XP 570 '15-16, CREW XP 1000 '17-18, CREW DIESEL '16-17

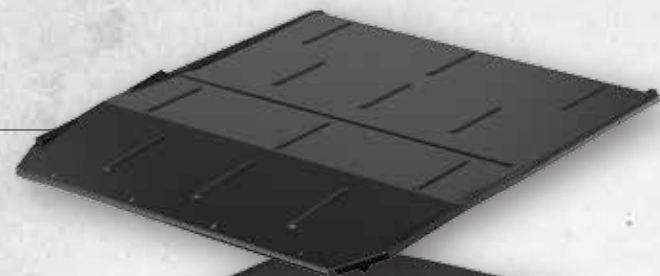

LOCK & RIDE

LIGHTWEIGHT ROOF - CANVAS

- » 3-SEAT • 2879039
- XP 900 '13-18, XP 570 '15-16, XP 1000 '18, XP 1000 '17, XP 1000 HL '18, DIESEL '14-17, CREW XP 1000 '17-18



LOCK & RIDE

LIGHTWEIGHT ROOF CREW - CANVAS

- » 2879898
- CREW XP 900 '14-18, CREW XP 570 '15-16, CREW XP 1000 '17-18, CREW DIESEL '16-17

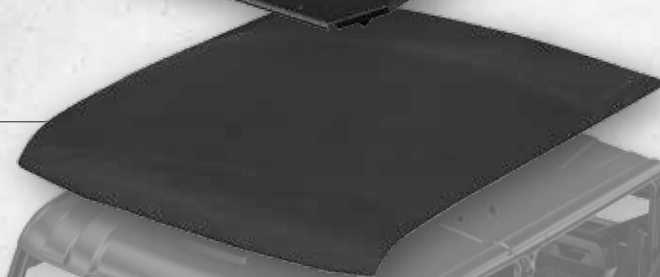

POLARIS ENGINEERED™ ADVANTAGES



SEALED COVERAGE

Just as roof shingles overlap for seamless coverage, roofs extend over other cab components to add even more protection against the elements, delivering the best fit - and the best seal.

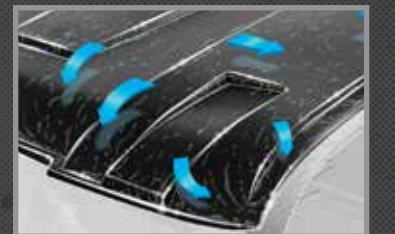

KEEP MOISTURE MOVING

Keep precipitation moving with integrated roof water channels that direct water away from the cab even when you're stationary.



PREMIUM FINISH & QUIETER RIDE

Roof liners provide a clean look by hiding wiring, and absorb noise for a quieter ride.

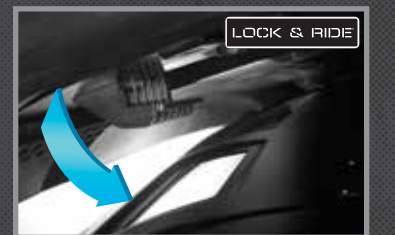

REVOLUTIONARY INSTALLATION

Lock & Ride™ roofs install directly into mounting points in the cab frame.

ULTIMATE CLARITY WITH GLASS

FOR THE ULTIMATE IN SCRATCH RESISTANCE AND CLARITY, nothing beats glass. It has the most optical clarity of any windshield material, so you can keep riding regardless of the weather. Reduce the dust swirl from the windshield and roof by adding a rear panel to keep the cab clean and comfortable.



ADD ALL-WEATHER VISIBILITY WINDSHIELD WIPER & WASHER SYSTEM
P. 28

TEMPERED SAFETY GLASS

For the ultimate in scratch resistance, tempered safety glass is the top choice. Optically, it is the clearest glass available, and because it is tempered, it's shatterproof.

POLARIS ENGINEERED™ ADVANTAGES



AIRTIGHT GASKET SEAL

RANGER® windshields feature a 360° gasket seal, preventing moisture and dust from entering the cab.

WINDSHIELDS



TIP-OUT WINDSHIELD - GLASS TOP SELLER

- Offers 3 positions—open, closed and vented
- Tip-out design allows for partial venting or open-air freedom
- Gas shocks assist in easy opening and closing
- 360° gasket for reliable protection and comfort
- Automotive-style curved glass
- Scratch-resistant safety glass
- Improved interior sound dampening and optimized visibility
- Bolt-on design installs directly on the cab frame
- Designated mounting locations

» **NEW** 2882874
XP 1000 '18
AVAILABLE FALL 2017



» 2882189
XP 900 '13-18, XP 570 '15-16, XP 1000 '17, XP 1000 HL '18, DIESEL '14-17, CREW XP 900 '14-18, CREW XP 570 '15-16, CREW XP 1000 '17-18

LOCK & RIDE FULL WINDSHIELD - GLASS TOP SELLER

- Provides the highest level of scratch resistance

» 2882191
XP 900 '13-18, XP 570 '15-16, XP 1000 '18, XP 1000 HL '18, DIESEL '14-17, CREW XP 900 '14-18, CREW XP 570 '15-16, CREW XP 1000 '17-18



REAR PANELS



REDUCE IN-CAB DUST SWIRL BY ADDING A REAR PANEL
With a windshield and roof installed, turbulent air develops behind the cab. Add a rear panel to reduce dust intrusion from this swirl.



LOCK & RIDE REAR PANEL - SLIDING GLASS

- Sliding window provides ventilation, cab comfort and access to cargo in rear box

» 2879015
XP 900 '13-18, XP 570 '15-16, XP 1000 '18, XP 1000 '17, XP 1000 HL '18, DIESEL '14-17, CREW XP 900 '14-18, CREW XP 570 '15-16, CREW XP 1000 '17-18, CREW DIESEL '16-17



LOCK & RIDE REAR PANEL - GLASS TOP SELLER

» 2879013
XP 900 '13-18, XP 570 '15-16, XP 1000 '18, XP 1000 '17, XP 1000 HL '18, DIESEL '14-17, CREW XP 900 '14-18, CREW XP 570 '15-16, CREW XP 1000 '17-18, CREW DIESEL '16-17



MULTI-FUNCTION FEATURES

Venting options are useful for controlling airflow into the cab. This allows you to regulate the temperature inside. A low-profile exterior framework on the windshields gives an unobstructed field of vision.



REVOLUTIONARY INSTALLATION

Every Lock & Ride® windshield utilizes a unique clamp that secures your windshield with the perfect amount of hold for rough trail conditions, yet still allows for easy, tool-less removal.

DURABLE POLY PROTECTION

LIGHT AND FLEXIBLE, poly is impact-resistant, providing long-term value and protection. Whether you choose hard coat, a general poly windshield, or rear panel, you can hit the trail or job site with confidence, protection and durability.



ADD ALL-WEATHER VISIBILITY
WINDSHIELD WIPER & WASHER SYSTEM
P. 28

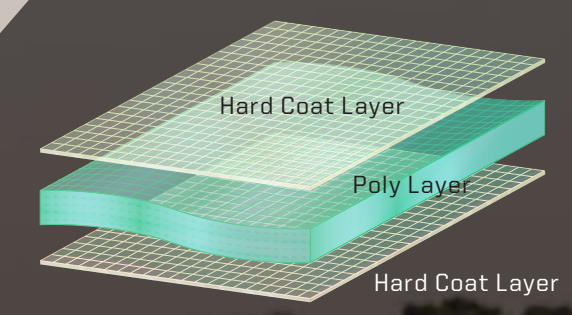

HARD COAT POLY

Poly windshields covered by hard coat provide **30x MORE** scratch resistance than any standard poly windshields.

POLARIS ENGINEERED™ ADVANTAGES



AIRTIGHT GASKET SEAL

RANGER windshields feature a 360° gasket seal, preventing moisture and dust from entering the cab.

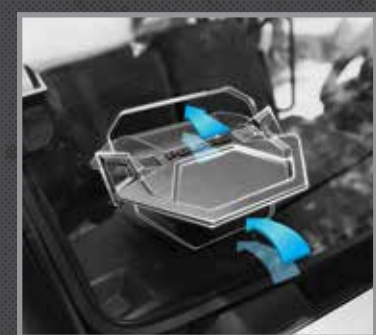

VENTING OPTIONS

Venting options are useful for controlling airflow into the cab. This allows you to regulate the temperature inside.



REVOLUTIONARY INSTALLATION

Every Lock & Ride® windshield utilizes a unique clamp that secures your windshield with the perfect amount of hold for rough trail conditions, yet still allows for easy, tool-less removal.

FULL-SIZE WINDSHIELDS & REAR PANELS

WINDSHIELDS

3-Position Adjustable
Open
Venting
Closed



LOCK & RIDE TIP-OUT WINDSHIELD - POLY

- 3-position adjustable to control cab airflow
- New improved handle

» 2880091
XP 900 '13-18, XP 570 '15-16, **XP 1000 '18**, XP 1000 '17, XP 1000 HL '18, DIESEL '14-17, CREW XP 900 '14-18, CREW XP 570 '15-16, CREW XP 1000 '17-18



LOCK & RIDE FULL WINDSHIELD VENTED - HARD COAT POLY **NEW**

- Frameless design for maximum visibility
- Added vents for airflow on a hot day or defrosting on a cold day

» 2883266
XP 900 '13-18, XP 570 '15-16, **XP 1000 '18**, XP 1000 '17, XP 1000 HL '18, DIESEL '15-17, CREW XP 900 '15-18, CREW XP 570 '15-16, CREW XP 1000 '17-18, CREW DIESEL '16-17



LOCK & RIDE FLIP-DOWN WINDSHIELD - HARD COAT POLY

- Two venting options: fully sealed, flip-down or remove upper half for some protection with maximum ventilation

» 2881919
XP 900 '13-18, XP 570 '15-16, XP 1000 '17, XP 1000 HL '18, DIESEL '14-17, CREW XP 900 '14-18, CREW XP 570 '15-16, CREW XP 1000 '17-18, CREW DIESEL '16-17



LOCK & RIDE FULL WINDSHIELD - POLY **NEW** **TOP SELLER**

- Frameless design for maximum visibility
- » **HARD COAT** 2883300
XP 900 '13-18, XP 570 '15-16, **XP 1000 '18**, XP 1000 '17, XP 1000 HL '18, DIESEL '15-17, CREW XP 900 '15-18, CREW XP 570 '15-16, CREW XP 1000 '17-18, CREW DIESEL '16-17
- » **GENERAL PURPOSE** 2883278
XP 900 '13-18, XP 570 '15-16, **XP 1000 '18**, XP 1000 '17, XP 1000 HL '18, DIESEL '15-17, CREW XP 900 '15-18, CREW XP 570 '15-16, CREW XP 1000 '17-18, CREW DIESEL '16-17



LOCK & RIDE FLIP-DOWN WINDSHIELD - HARD COAT POLY **NEW**

- Two venting options: fully sealed, flip-down or remove upper half for some protection with maximum ventilation

» 2883261
XP 1000 '18



LOCK & RIDE HALF WINDSHIELD - POLY **TOP SELLER**

- Deflects air flow from straight on, but still provides air flow in the cab
- » **NEW** 2883301
XP 1000 '18
- » 2879135
XP 900 '13-18, XP 570 '15-16, **XP 1000 '18**, XP 1000 '17, XP 1000 HL '18, DIESEL '15-17, CREW XP 900 '15-18, CREW XP 570 '15-16, CREW XP 1000 '17-18, CREW DIESEL '16-17

REAR PANELS



REDUCE IN-CAB DUST SWIRL BY ADDING A REAR PANEL
With a windshield and roof installed, turbulent air develops behind the cab. Add a rear panel to reduce dust intrusion from this swirl.

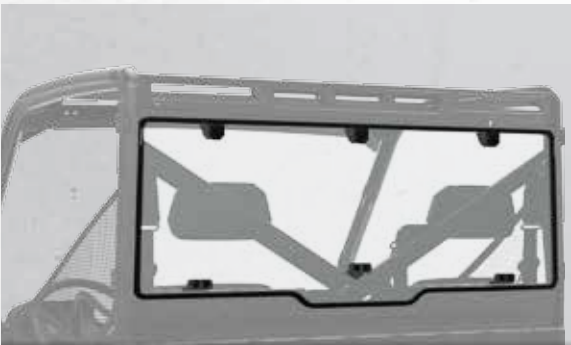

LOCK & RIDE REAR PANEL - POLY **TOP SELLER**

- Strong, thick polycarbonate provides outstanding impact and scratch resistance
- Installs in contours of cab frame with 360° gasketing for outstanding protection, comfort, fit and finish

» 2879134
XP 900 '13-18, XP 570 '15-16, **XP 1000 '18**, XP 1000 '17, XP 1000 HL '18, DIESEL '14-17, CREW XP 900 '14-18, CREW XP 570 '15-16, CREW XP 1000 '17-18, CREW DIESEL '16-17



LOCK & RIDE REAR PANEL - CANVAS

- Heavy-duty cinch-tight buckles for a snug, secure fit
- Panel installs easily into integrated mounting locations

» 2879040
XP 900 '13-18, XP 570 '15-16, **XP 1000 '17**, XP 1000 HL '18, DIESEL '14-17, CREW XP 900 '14-18, CREW XP 570 '15-16, CREW XP 1000 '17-18, CREW DIESEL '16-17

THE BEST CAB COMPLETED

GET UNMATCHED PERFORMANCE AND THE BEST SEAL with the **RANGER Pro Shield™ Cab System** door line. This is more than just another door. It offers premium features like high-quality latches that feel secure and stay secure, integrated storage, venting options, configuration for audio components and much more. Experience a new level of interior comfort.

PREMIUM POLY

Constructed of heavy-duty 2.54 cm tube frames and injection-molded rigid plastic, these doors have the overall rigidity to maintain a perfect seal while traversing rough terrain. Interior/exterior handles help doors shut securely.

DOORS ALSO FEATURE:

- Built-in storage
- Pre-designated mounts for speakers
- Integrated panels - allowing for color matching or customization
- TPE liner for easy cleaning

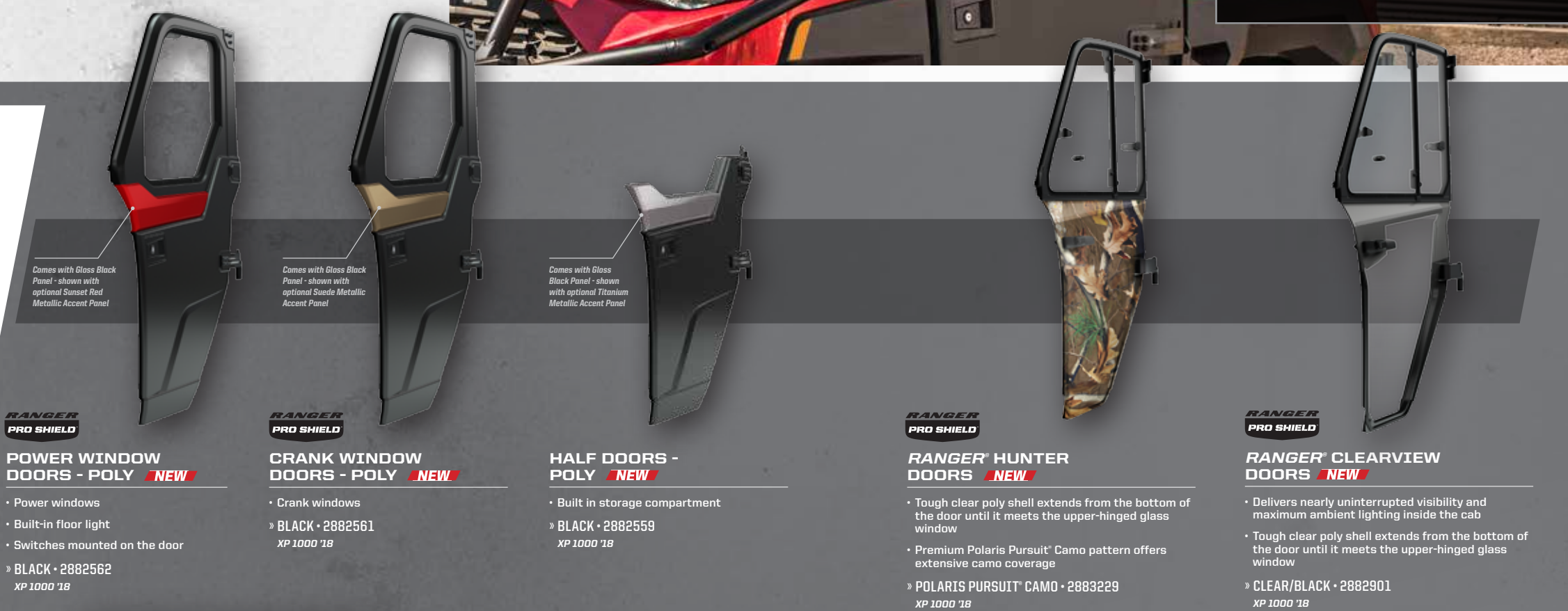

Comes with Glass Black Panel - shown with optional Sunset Red Metallic Accent Panel

Comes with Glass Black Panel - shown with optional Suede Metallic Accent Panel

Comes with Glass Black Panel - shown with optional Titanium Metallic Accent Panel

RANGER PRO SHIELD

POWER WINDOW DOORS - POLY NEW

- Power windows
- Built-in floor light
- Switches mounted on the door

» BLACK • 2882562
XP 1000 '18

RANGER PRO SHIELD

CRANK WINDOW DOORS - POLY NEW

- Crank windows

» BLACK • 2882561
XP 1000 '18

RANGER PRO SHIELD

HALF DOORS - POLY NEW

- Built in storage compartment

» BLACK • 2882559
XP 1000 '18

RANGER PRO SHIELD

RANGER® HUNTER DOORS NEW

- Tough clear poly shell extends from the bottom of the door until it meets the upper-hinged glass window
- Premium Polaris Pursuit™ Camo pattern offers extensive camo coverage

» POLARIS PURSUIT™ CAMO • 2883229
XP 1000 '18

RANGER PRO SHIELD

RANGER® CLEARVIEW DOORS NEW

- Delivers nearly uninterrupted visibility and maximum ambient lighting inside the cab
- Tough clear poly shell extends from the bottom of the door until it meets the upper-hinged glass window

» CLEAR/BLACK • 2882901
XP 1000 '18

ADD MORE TO YOUR DOORS

Select doors are set up for speaker installation right from the factory. Add style to the door by installing an accent panel that matches your vehicle's color.

(Available only for Power, Crank & Half doors)



EXTERIOR DOOR ACCENT PANEL NEW

- Replace stock gloss black accent panel with color-matched accent panel
 - Painted plastic & clear-coated for UV protection
 - Install easily with a single screw
- » ■ SUNSET RED METALLIC 2882870-520
 - » ■ SUEDE METALLIC 2882870-577
 - » ■ POLARIS PURSUIT™ CAMO 2882870-587
 - » ■ TITANIUM METALLIC 2882870-632
 - » ■ SAGE GREEN 2882870-560
XP 1000 '18 (ALL COLORS)



CANVAS

Lightweight, durable protection with adjustable zipper ventilation and see-through bottom panel.

ZIP WINDOW DOORS - CANVAS NEW

- 1.3 cm Tubular Steel Frame
- » BLACK • 2882902
 - » POLARIS PURSUIT™ CAMO • 2882903
XP 1000 '18
Fall availability



A PERFECT FIT FOR THE PERFECT SEAL

Polaris Engineered™ cab components fit perfectly into the contours of the cab frame, with a 360° gasket seal, and feature floor panels designed to deliver unmatched sealing performance.

POLARIS ENGINEERED™ ADVANTAGES



PREMIUM FEATURES

Automotive-like finish, solid latches, audio-ready, courtesy lights, storage and more.

QUIETER AT IDLE

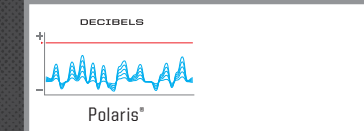

SOUND DAMPENING DOOR LINERS

Select doors come standard with sound-absorbing liners to help reduce in-cab noise.



VENTILATION OPTIONS

Choose from multiple window options - power, crank, hinged and zippers to find the perfect amount of ventilation.



INTEGRATED CONTROLS

Latch and window controls are integrated where they should be, on the door.



REVOLUTIONARY INSTALL

Adding or removing your doors is as simple as dropping them in and pulling them off. Easy, convenient and takes only seconds to remove the restraint rubber strap.

FULL-SIZE DOORS (XP 1000)

COMPLETE YOUR CAB SYSTEM



POLARIS ENGINEERED™ ADVANTAGES



PREMIUM FEATURES
Automotive-like finish, solid latches, storage and more.

QUIETER AT IDLE

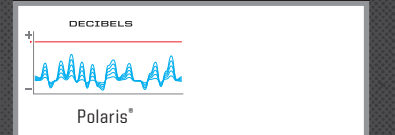

SOUND DAMPENING DOOR LINERS

Select doors come standard with sound-absorbing liners to help reduce in-cab noise.



UNPRECEDENTED VENTILATION OPTIONS

Choose from multiple window options –including power, hinged and zipper windows. This allows you to find the perfect amount of ventilation and temperature regulation.



REVOLUTIONARY INSTALLATION

Adding or removing your doors is as simple as dropping them in and pulling them off. Easy, convenient, and takes only seconds to remove the restraint rubber strap.

FULL-SIZE DOORS (XP 900)

POLY Heavy-duty tube frames with hard molded shells and cab seal systems for the best all-weather protection



POWER WINDOW DOORS - POLY

- Premium interior door liner
- Includes cab seal system

» **BLACK • 2880503**
XP 900 '13-18, XP 570 '15-16, XP 1000 '17, XP 1000 HL '18, DIESEL '14-17

HINGED WINDOW DOORS - POLY

- Sound-dampening, washable premium liner
- Includes cab seal system

» **BLACK • 2881253** » **POLARIS® PURSUIT® CAMO • 2881460**
XP 900 '13-18, XP 570 '15-16, XP 1000 '17, XP 1000 HL '18, DIESEL '14-17, CREW XP 900 '14-18, CREW XP 570 '15-16, CREW XP 1000 '17-18, CREW DIESEL '16-17, XP 570 '15-16, CREW XP 1000 '17-18, CREW DIESEL '16-17



FIXED WINDOW REAR DOORS - POLY

- Sound-dampening, washable premium liner
- Includes cab seal system

» **BLACK • 2879641** » **POLARIS® PURSUIT® CAMO • 2880641**
CREW XP 900 '14-18, CREW XP 570 '15-16, CREW XP 1000 '17-18, CREW DIESEL '16-17

CANVAS Lightweight, durable protection with adjustable zipper ventilation and see-through bottom panel



ZIP WINDOW DOORS - CANVAS TOP SELLER

- Durable UV-protected vinyl material features see-through bottom panel and adjustable zippered ventilation

» **BLACK • 2878853** » **POLARIS® PURSUIT® CAMO • 2882195**
XP 900 '13-18, XP 570 '15-16, XP 1000 '17, XP 1000 HL '18, DIESEL '14-17, CREW XP 900 '14-18, CREW XP 570 '15-16, CREW XP 1000 '17-18, CREW DIESEL '16-17



ZIP WINDOW REAR DOORS - CANVAS

- Durable UV protected vinyl material features Polaris Pursuit® Camo pattern

» **BLACK • 2879899** » **POLARIS® PURSUIT® CAMO • 2882196**
CREW XP 900 '14-18, CREW XP 570 '15-16, CREW XP 1000 '17-18, CREW DIESEL '16-17

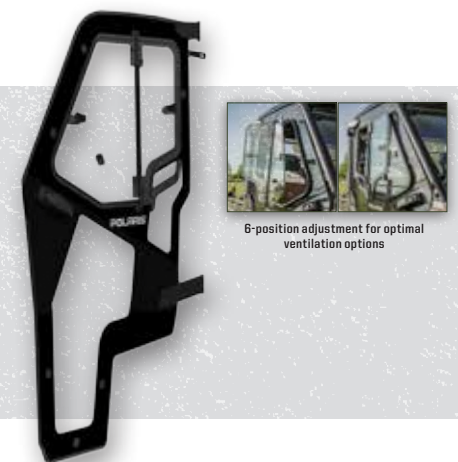

RANGER® CLEARVIEW DOORS

- Made of clear poly for maximum visibility
- Adjustable pivoting windows provide six ventilation options

» **CLEAR/BLACK • 2882188**
XP 900 '13-18, XP 570 '15-16, XP 1000 '17, XP 1000 HL '18, DIESEL '14-17

POLY REAR DOOR LINERS

- Quickly and easily add comfort, class and noise reduction to crew rear poly doors
- Features a soft-touch liner and contour to match our factory front door liners

» **2882197**
CREW XP 900 '14-18, CREW XP 570 '15-16, CREW XP 1000 '17-18, CREW DIESEL '16-17

STEEL Keeps debris out of the cab while maintaining an open-air riding experience

HALF DOORS - STEEL

- Keep the trail debris out while maintaining great airflow into the cab
- Heavy-duty steel frame with slam latch fits perfectly to the chassis

» **BLACK • 2879797**
XP 900 '13-18, XP 570 '15-16, XP 1000 '17, XP 1000 HL '18, DIESEL '14-17



**CONVENIENCE
FEATURES**

**EPS SYSTEM
(ELECTRIC POWER STEERING)**

- » 2880083
XP 900 '13-18, XP 570 '15-16, XP 1000 '17, XP 1000 HL '18, DIESEL '14-17, CREW XP 900 '14-18, CREW XP 570 '15-16, CREW XP 1000 '17-18, CREW DIESEL '16-17

**CAB SEAL SYSTEM
- 2 & 3 SEAT**

- Included in all poly door kits
- » 2883253 **NEW** 
XP 1000 '18
- » 2879385
XP 900 '13-18, XP 570 '15-16, XP 1000 '17, XP 1000 HL '18, DIESEL '14-17

**NOISE REDUCTION
SYSTEM**

- » 2881508
XP 900 '13-18, XP 570 '15-16, XP 1000 '17, XP 1000 HL '18, DIESEL '14-17, CREW XP 900 '14-18, CREW XP 570 '15-16, CREW XP 1000 '17-18, CREW DIESEL '16-17

HORN 

- » 2882764 **NEW**
XP 1000 '18
2875048
XP 570 '16, EV '11-14, CREW 570-4 '14, CREW 500-4 '13, 800 '13-14, 570 '14, 570 FULL SIZE '17-18, 500-4 '11, 500 '11-13, 400 '11-14
- » 2879273
XP 900 '13-18, XP 570 '15-16, XP 1000 '17, XP 1000 HL '18, EV '15-18, EV LI-ION '18, EV LI ION '16, ETX '15-16, DIESEL '14-17, CREW XP 900 '14-18, CREW XP 570 '15-16, CREW XP 1000 '17-18, CREW DIESEL '16-17, CREW 570-4 '15-18, 570 '15-18, 500 '17-18

**REVERSE WARNING
ALERT**

- » 2883246 **NEW**
XP 1000 '18
- » 2876228
XP 900 '13-18, XP 570 '15-16, XP 1000 '17, XP 1000 HL '18, DIESEL '14-17, CREW XP 900 '14-18, CREW XP 570 '15-16, CREW XP 1000 '17-18, CREW DIESEL '13-17, CREW 570-4 '14, CREW 500-4 '13, 800 '13-14, 570 '14, 570 FULL SIZE '17-18, 500-4 '11, 500 '11-13, 400 '11-14

GATED SHIFTER

- Creates positive shift points between forward and reverse gears
- Eliminates accidental shifts to park or high-range
- Reduces stress on shift linkage and driveline components

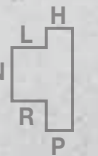

- » 2880834
XP 900 '13-18, XP 570 '15-16, XP 1000 '17, XP 1000 HL '18, DIESEL '14-17, CREW XP 900 '14-18, CREW XP 570 '15-16, CREW XP 1000 '17-18, CREW DIESEL '16-17



ADJUSTABLE



FULL BENCH

POLARIS RANGER XP® FULL-SIZE SEATSAVER™ - SPLIT BENCH SEAT

- » **NEW** REALTREE XTRA™ CAMO • 2883244-587
- » **NEW** CARHARTT® BROWN • 2883244-218
- » **NEW** CARHARTT® GRAVEL • 2883244-458
XP 1000 '18
- » REALTREE XTRA™ CAMO • 2882352-587
- » CARHARTT® BROWN • 2882352-218
- » CARHARTT® GRAVEL • 2882352-458

XP 900 '13-17, XP 570 '15-16, XP 1000 '17, XP 1000 HL '18, DIESEL '14-17, CREW XP 900 '14-18, CREW XP 570 '15-16, CREW XP 1000 '17-18

FULL-SIZE SEATSAVER™ - FULL BENCH SEAT

- » REALTREE XTRA™ CAMO • 2882351-587
- » CARHARTT® BROWN • 2882351-218
- » CARHARTT® GRAVEL • 2882351-458

XP 900 '13-18, XP 570 '15-16, XP 1000 '17, DIESEL '14-17, CREW XP 900 '14-18, CREW XP 570 '15-16, CREW XP 1000 '17-18

**ADD COMFORT AND
CAPABILITY**

ADD SUPERIOR ALL-WEATHER FUNCTIONALITY and comfort to your RANGER® with premium Polaris Engineered™ Cab Accessories. Keep warm on the coldest of days with a heater kit and improve visibility with a Windshield Wiper & Washer System or Rear View Camera Mirror.

⚠ A Battery Connection Cable is required for Polaris RANGER® models that do not come stock with a winch for the installation of a Windshield Wiper & Washer Kit, Heater & Defrost Kit and more.
(Full-Size, 2879388 or Full-Size Crew, 2879685)



WINDSHIELD WIPER & WASHER SYSTEM **TOP SELLER**

- 17" mounted wiper and washer kit included
- Refillable reservoir under front hood holds approximately 2 liters
- Rocker switch to turn on wiper or spray wash fluid
- Mounting hardware and wiring included

- » **NEW** 2882754
XP 1000 '18
⚠ Requires 2882904



8-VENT HEATER & DEFROST SYSTEM **TOP SELLER**

- Easily control the climate inside your cab in any season
- Three different fan speeds
- Heat and fan dash-mounted controls
- Helps defrost windshields and keeps you warm or cool
- Manual vents

- » **NEW** 2882753
XP 1000 '18
AVAILABLE FALL 2017



POLARIS® REMOTE GARAGE DOOR OPENER BY HOMELINK™

- HomeLink™ technology allows you to control up to two garage doors

- » 2882082

XP 900 '13-18, XP 570 '15-16, **XP 1000 '18**, XP 1000 '17, XP 1000 HL '18, DIESEL '14-17, CREW XP 900 '14-18, CREW XP 570 '15-16, CREW XP 1000 '17, CREW DIESEL '13-17, CREW 570-16-17, CREW 570 FULL SIZE '18, 800 '13-14, 570 FULL SIZE '17-18, CREW 570 FULL SIZE '18, 800 '13-14, 570 FULL SIZE '17-18

- ⚠ Requires Battery Connection Cable



MULTI-COLOR FUNCTIONALITY

MULTI-FUNCTION CAB LIGHT **NEW**

- Can be removed to use as a flashlight in and around your vehicle
- LED dome light provide, white, red, green and blue lighting options
- Red light is great for reading maps or any activity you want to save your night vision for
- Green light is perfect for navigating in the dark without disturbing game
- Blue light is ideal for night hunting without sacrificing your night vision, or night fishing, since it doesn't produce any glare when shined through the water
- Battery-operated and recharges when the vehicle is on

- » 2882871
XP 1000 '18

HEATED SEAT SYSTEM - 3 PASSENGER

- Increase your comfort in the colder months with heated seats
- Installs into stock seats

- » 2883262 **NEW**
XP 1000 '18

- » 2879271

XP 900 '13-18, XP 570 '15-16, XP 1000 '17, XP 1000 HL '18, DIESEL '14-17, CREW XP 900 '14-18, CREW XP 570 '15-16, CREW XP 1000 '17-18, CREW DIESEL '16-17

- ⚠ Requires Battery Connection Cable



FLOOR MATS - 3 SEAT **NEW**

- » 2882780
XP 1000 '18



DOME LIGHT

- Fits Poly and Premium Roofs only

- » 2879270

XP 900 '13-18, XP 570 '15-16, **XP 1000 '18**, XP 1000 '17, XP 1000 HL '18, DIESEL '14-17, CREW XP 900 '14-18, CREW XP 570 '15-16, CREW XP 1000 '17-18, CREW DIESEL '13-17, CREW 570 '16-17, CREW 570 FULL SIZE '18, 800 '13-14, 570 FULL SIZE '17-18, CREW 570 FULL SIZE '18, 800 '13-14, 570 FULL SIZE '17-18

WATCH.



RECORD.



SHARE.



REAR VIEW CAMERA MIRROR

- Mirror automatically switches to a 10.2 cm back-up display when shifting to reverse

- » 2881483

XP 900 '13-18, XP 570 '15-16, XP 1000 '17, XP 1000 HL '18, DIESEL '14-17, CREW XP 900 '14-18, CREW XP 570 '15-16, CREW XP 1000 '17-18, CREW DIESEL '13-17, CREW 570 '16-17, CREW 570 FULL SIZE '18, 800 '13-14, 570 FULL SIZE '17-18, CREW 570 FULL SIZE '18, 800 '13-14, 570 FULL SIZE '17-18

- ⚠ Requires Battery Connection Cable

WIDE ANGLE REAR VIEW MIRROR

- Large 6.4 cm x 35.6 cm adjustable convex mirrored surface gives you a full-spectrum view

- » 2881439

XP 900 '13-18, XP 570 '15-16, **XP 1000 '18**, XP 1000 '17, XP 1000 HL '18, DIESEL '14-17, CREW XP 900 '14-18, CREW XP 570 '15-16, CREW XP 1000 '17-18, CREW DIESEL '16-17

LARGE REAR VIEW MIRROR **TOP SELLER**

- » 2879969

XP 900 '13-18, XP 570 '15-16, **XP 1000 '18**, XP 1000 '17, XP 1000 HL '18, DIESEL '14-17, CREW XP 900 '14-18, CREW XP 570 '15-16, CREW XP 1000 '17-18, CREW DIESEL '13-17, CREW 570-16-17, CREW 570 FULL SIZE '18, 800 '13-14, 570 FULL SIZE '17-18, CREW 570 FULL SIZE '18, 800 '13-14, 570 FULL SIZE '17-18

OFF-ROAD GRADE AUDIO

Research audio solutions for Polaris RANGER®, and you'll see manufacturers brag about audio equipment that's "Marine Grade", or worse yet, you'll discover repackaged components built for automotive applications.

Polaris®, combined with MB Quart®, engineers off-road grade audio equipment that's proven in the harshest conditions. Rain, snow, mud, heat, cold, dust - any place your RANGER® excels, so will your audio.



MB QUART®

BUILD YOUR SYSTEM

1 SELECT YOUR HEAD UNIT p. 31

2 CHOOSE YOUR SPEAKERS p. 31

3 FIND YOUR SYSTEM KIT p. 32-33

HEAD UNITS + SPEAKERS

These solutions get you well on your way to hitting the trails with your favorite tunes. Each features head units, allowing you to control audio delivery. Both the Dash Stereo and Visor Stereo are all-in-one solutions that can serve as the base and expanded system with more speakers.



BLUETOOTH®, APPLE® CONTROL, AM/FM DASH STEREO & 2 X 5.25" (5 X 13 CM) SPEAKERS BY MB QUART®

- All-in-one solution for giving your vehicle a performance-ready sound system
- AM/FM tuner with external antenna for reliable reception
- Powerful 45-watt x 4 channel amplifier
- Two off-road grade 5.25" (13 cm) speakers
- USB input and Bluetooth® compatible for wireless streaming
- System mounts into pre-designated mounting locations in the vehicle dash
- Easily add on other components to customize system

» 2882750
XP 1000 '18

» 2882030
XP 900 '13-18, XP 570 '15-16, XP 1000 '17, XP 1000 HL '18, DIESEL '14-17, CREW XP 900 '14-18, CREW XP 570 '15-16, CREW XP 1000 '17-18, CREW DIESEL '16-17



BLUETOOTH®, APPLE® CONTROL, AM/FM VISOR STEREO & 4 X 6.5" (10 X 16.5 CM) SPEAKERS BY MB QUART®

- One-step audio solution for your off-road vehicle audio system
- AM/FM/USB/Bluetooth® stereo
- Integrated 300-watt amplifier
- Four 6.5" (16.5 cm) off-road grade coaxial speakers with .75" (1.9 cm) titanium dome tweeters
- Remote mount USB/3.5mm input plug for a dash panel
- Includes all of the necessary mounting hardware and new plug for wiring

» 2882888
XP 1000 '18

SPEAKERS

Your RANGER® is ready for work, but is it ready to entertain? From a simple two-speaker setup to complete system with audio pods and a subwoofer—BUILD IT YOUR WAY.



2 X 6.5" (5 X 16.5 CM) 2-WAY REAR ROOF SPEAKERS BY MB QUART®

- Enhance any audio system in your RANGER®
- Two 6.5" (16.5 cm) off-road grade coaxial speakers with .75" (1.9 cm) titanium dome tweeters
- Installs in the rear corners of the roof with simple hand tools
- Connects to either the Dash Audio Kit or the Premium Audio Visor

» 2882876
XP 900 '13-18, XP 570 '15-16, XP 1000 '18, XP 1000 '17, XP 1000 HL '18, DIESEL '15-17



4 X 6.5" (10 X 16.5 CM) 2-WAY VISOR SPEAKERS BY MB QUART®

- One-step audio solution for your off-road vehicle audio system
- Integrated 300-watt amplifier
- Four 6.5" (16.5 cm) off-road grade coaxial speakers with .75" (1.9 cm) titanium dome tweeters
- Remote mount USB/3.5mm input plug for mounting in the dash panel
- Installs easily under the RANGER® roof using simple hand tools
- 4 switch blanks offer convenient locations for additional switched accessories

» 2882891
XP 1000 '18



2 X 6.5" (5 X 16.5 CM) 2-WAY DOOR SPEAKERS BY MB QUART®

- Uncompromising sound quality & performance
- Two 6.5" (16.5 cm) off-road grade coaxial speakers with .75" (1.9 cm) titanium dome tweeters
- IPX67 rated
- Kit includes mounting hardware/harness and installs in minutes using simple hand tools

» 2882889
XP 1000 '18

SYSTEM KITS HEAD UNIT: DASH STEREO & SPEAKERS



ROOF + DOOR + VISOR SPEAKERS



HEAD UNIT

2882750 Dash Radio

SPEAKERS

2882876 Rear Roof Speakers
2882889 Door Speakers
2882891 Visor Speakers

HARNESSES

2882904 POLARIS PULSE® ROOF 6
2883408 Amplifier

TOTAL:

XP 1000 '18
REQUIRES 2882911, 2882912 OR 2882913

REAR ROOF + DOOR SPEAKERS



HEAD UNIT

2882750 Dash Radio

SPEAKERS

2882876 Rear Roof Speakers
2882889 Door Speakers

HARNESSES

2883408 Amplifier

TOTAL:

XP 1000 '18
REQUIRES 2882911, 2882912 OR 2882913

DOOR + VISOR SPEAKERS



HEAD UNIT

2882750 Dash Radio

SPEAKERS

2882889 Door Speakers
2882891 Visor Speakers

HARNESSES

2882904 POLARIS PULSE® ROOF 6

TOTAL:

XP 1000 '18
REQUIRES 2882911, 2882912 OR 2882913

REAR ROOF + VISOR SPEAKERS



HEAD UNIT

2882750 Dash Radio

SPEAKERS

2882876 Rear Roof Speakers
2882891 Visor Speakers

HARNESSES

2882904 POLARIS PULSE® ROOF 6

TOTAL:

XP 1000 '18
REQUIRES 2882911, 2882912 OR 2882913

VISOR SPEAKERS



HEAD UNIT

2882750 Dash Radio

SPEAKERS

2882891 Visor Speakers

HARNESSES

2882904 POLARIS PULSE® ROOF 6

TOTAL:

XP 1000 '18
REQUIRES 2882911, 2882912 OR 2882913

REAR ROOF SPEAKERS



HEAD UNIT

Dash Radio
2882750

SPEAKERS

2882876 Rear Roof Speakers

HARNESSES

None Required | Battery Connection
2879388

TOTAL:

XP 1000 '18
REQUIRES 2882911,
2882912 OR 2882913

Dash Radio
2882030

XP 900 '13-18,
XP 570 '15-16, XP 1000 '17,
XP 1000 HL '18, DIESEL '14-17

DOOR SPEAKERS



HEAD UNIT

2882750 Dash Radio

SPEAKERS

2882889 Door Speakers

HARNESSES

None Required

TOTAL:

XP 1000 '18
REQUIRES 2882911, 2882912 OR 2882913

DASH STEREO + SPEAKERS

XP 1000 '18

HEAD UNIT

2882750 Dash Radio

HARNESSES

None Required

TOTAL:

XP 900 '13-18, XP 570 '15-16, XP 1000 '17,
XP 1000 HL '18, DIESEL '14-17

HEAD UNIT

2882030 Dash Radio

HARNESSES

2879388 Battery Connection

TOTAL:

CREW XP 900 '14-18, CREW XP 570 '15-16,
CREW XP 1000 '17, CREW DIESEL '16-17

HEAD UNIT

2882030 Dash Radio

HARNESSES

2879685 Battery Connection

TOTAL:

HEAD UNIT: VISOR STEREO



REAR ROOF + DOOR SPEAKERS



HEAD UNIT

2882888 Visor Unit

SPEAKERS

2882876 Rear Roof Speakers
2882889 Door Speakers

HARNESSES

2882904 POLARIS PULSE® ROOF 6

TOTAL:

XP 1000 '18
REQUIRES 2882911, 2882912 OR 2882913

DOOR SPEAKERS



HEAD UNIT

2882888 Visor Unit

SPEAKERS

2882889 Door Speakers

HARNESSES

2882904 POLARIS PULSE® ROOF 6

TOTAL:

XP 1000 '18
REQUIRES 2882911, 2882912 OR 2882913

REAR ROOF SPEAKERS



HEAD UNIT

2882888 Visor Unit

SPEAKERS

2882876 Rear Roof Speakers

HARNESSES

2882904 POLARIS PULSE® ROOF 6

TOTAL:

XP 1000 '18
REQUIRES 2882911, 2882912 OR 2882913

VISOR STEREO



HEAD UNIT

2882888 Visor Unit

HARNESSES

2882904 POLARIS PULSE® ROOF 6

TOTAL:

XP 1000 '18
REQUIRES 2882911, 2882912 OR 2882913

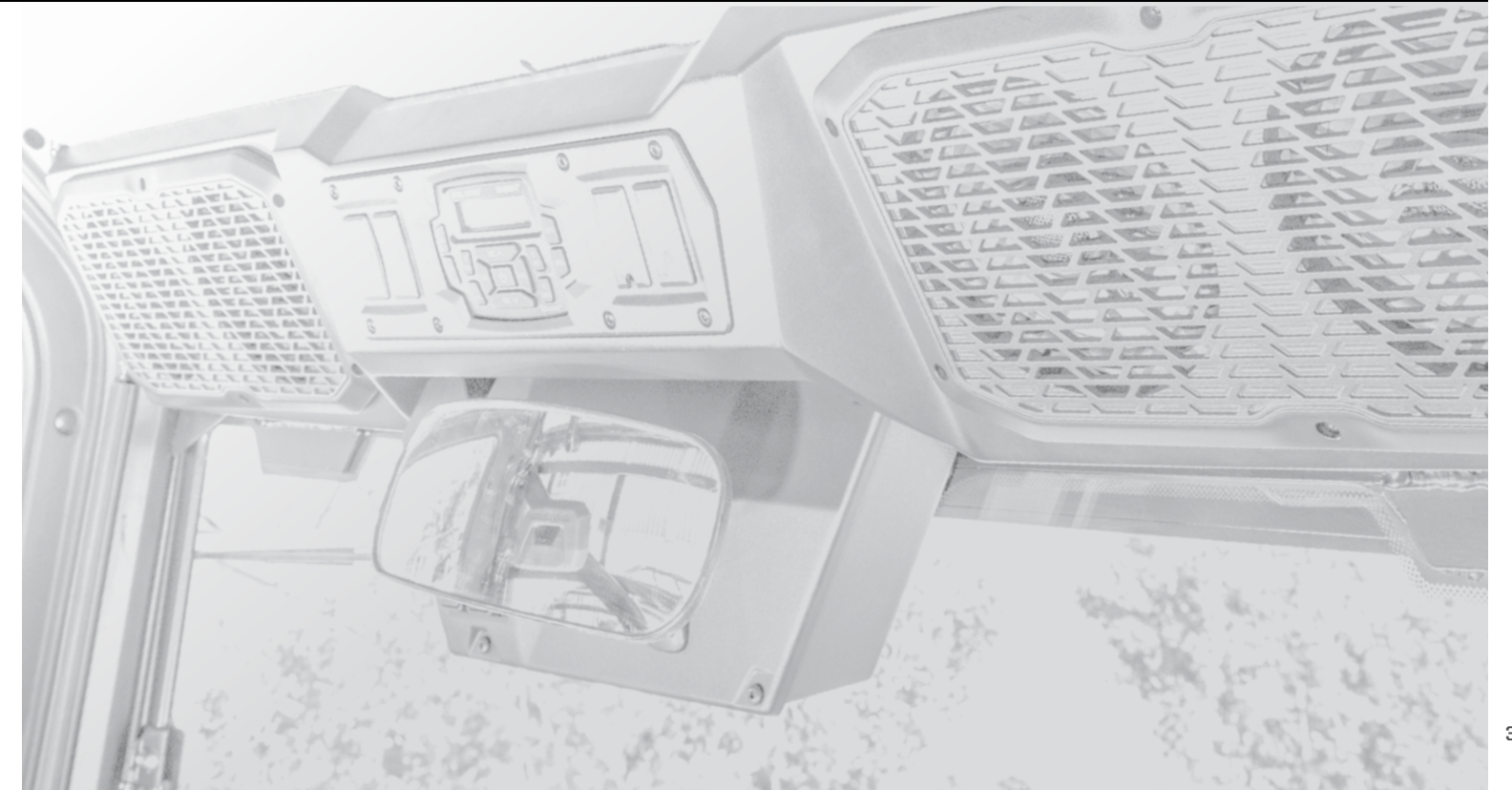

HAUL MORE DO MORE

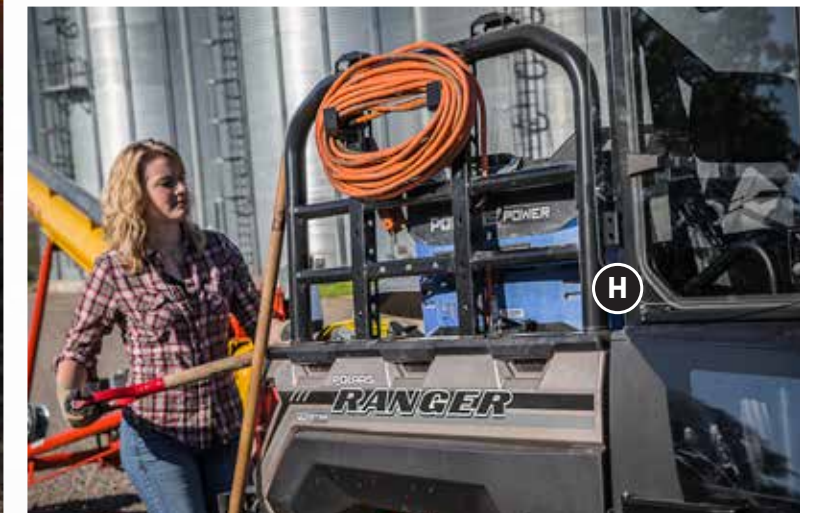

FULL-SIZE STORAGE

NO MATTER WHAT THE DAY CALLS FOR, HAUL IT ALL with Polaris Engineered™ storage accessories. Featuring Lock & Ride® technology, accessories can be easily added or removed, reconfiguring the cargo bed within moments to tackle the task at hand.

FEATURED RANGER XP® 1000 ACCESSORIES

- A. RANGER® CLEARVIEW DOORS 2882901
- B. LOCK & RIDE SPORT ROOF-POLY 2882911
- C. LOCK & RIDE FULL VENTED WINDSHIELD-HARD COAT POLY 2883266

- D. LOCK & RIDE REAR PANEL-POLY 2879134
- E. PRO HD 4,500 LB. WINCH 2882715
- F. PRO ARMOR® WHEEL & TIRE SET: PRESERVE™ 27" WITH BUCKLE ACCENT 2883203

- G. LOCK & RIDE TOOL RACK 2881533
- H. LOCK & RIDE CARGOMAX SYSTEM 2882177
- I. LOCK & RIDE CARGO BOX 2883279

DONE THE RIGHT WAY

POLARIS ENGINEERED ACCESSORIES™ deliver the versatility to haul more, tow more and do more all day long.



LOCK & RIDE

TIP-DOWN HEADACHE RACK

- Rack tips down for additional storage solutions with space below and multiple tie-down points
- Lightweight and heavy-duty rack protects the cab of your RANGER and lets you haul even more
- Works with Lock & Ride® Bed Rails

» 2881531

XP 900 '13-18, XP 570 '15-16, **XP 1000 '18**, XP 1000 '17, XP 1000 HL '18, DIESEL '14-17, CREW XP 900 '14-18, CREW XP 570 '15-16, CREW XP 1000 '17-18, CREW DIESEL '16-17, 570 FULL SIZE '17-18

LOCK & RIDE

CARGOMAX SYSTEM

- Comes standard with a support bar that ties the two sides together for a sturdy cargo hold.
- Designed to attach to the Lock & Ride® Tip-Down Headache Rack for additional support and three-sided containment
- Adjustable utility hooks provide more options for hanging tools, cords or gear
- Two sides and a support bar included

» 2882177

XP 900 '13-18, XP 570 '15-16, **XP 1000 '18**, XP 1000 '17, XP 1000 HL '18, DIESEL '14-17, CREW XP 900 '14-18, CREW XP 570 '15-16, CREW XP 1000 '17-18, CREW DIESEL '13-17, CREW 570 '16-17, CREW 570 FULL SIZE '18, 800 '13-14, 570 FULL SIZE '17-18, CREW 570 FULL SIZE '18, 800 '13-14, 570 FULL SIZE '17-18



LOCK & RIDE

EXCLUSIVELY AVAILABLE ON POLARIS® VEHICLES, LOCK & RIDE® ACCESSORIES LET YOU QUICKLY CHANGE FROM ONE TASK TO ANOTHER WITH HUNDREDS OF OPTIONS.



WITH THE FLIP OF A LEVER, LOCK & RIDE® PLUNGERS USE OUTWARD PRESSURE TO EXPAND FOR A SECURE FIT.



LOCK & RIDE

BED EXTENDER/DIVIDER

- Extend or divide the cargo box
- Multiple tie-down points available to secure cargo
- Installs in any location in the box

» 2882752

XP 1000 '18 **NEW**

» 2879117

XP 900 '13-18, XP 570 '15-16, XP 1000 '17, XP 1000 HL '18, DIESEL '14-17, CREW XP 900 '14-18, CREW XP 570 '15-16, CREW XP 1000 '17-18, CREW DIESEL '13-17, CREW 570-6 '17, CREW 570 FULL SIZE '18, 800 '13-14



FRONT HOOD STORAGE RACK

- Front curve helps keep cargo in place when traveling
- Provides additional protection
- Fully integrated pivots to gain under-hood access

» 2882690

XP 1000 '18 **NEW**

» 2881459

XP 900 '13-18, XP 570 '15-16, XP 1000 '17, XP 1000 HL '18, DIESEL '14-17, CREW XP 900 '14-18, CREW XP 570 '15-16, CREW XP 1000 '17-18, CREW DIESEL '16-17



CARGO BED MAT

- Non-slip surface to better secure loads & keep cargo bed clean

» 2882751

XP 1000 '18

» 2881484

XP 900 '13-18, XP 570 '15-16, XP 1000 '17, XP 1000 HL '18, DIESEL '14-17, CREW XP 900 '14-18, CREW XP 570 '15-16, CREW XP 1000 '17-18, CREW DIESEL '16-17, 570 FULL SIZE '17-18



LOCK & RIDE BED RAILS

- Heavy-duty steel construction with a rugged powder-coat finish
- Features several additional tie-down points for load securing options

» 2881532

XP 900 '13-18, XP 570 '15-16, **XP 1000 '18**, XP 1000 '17, XP 1000 HL '18, DIESEL '14-17, CREW XP 900 '14-18, CREW XP 570 '15-16, CREW XP 1000 '17-18, CREW DIESEL '16-17, CREW 570-6 '17, CREW 570 FULL SIZE '18, 570 FULL SIZE '17-18

LOCK & RIDE D-RINGS

- The most versatile Lock & Ride® accessory - add as many as you need to secure your cargo with bungee cords or straps

» 2881545

ALL RANGER® CARGO BOXES



RATCHET TIE-DOWN STRAPS

» RED • 2859047-01

» BLACK • 2859047-02



LOCK & RIDE CARGO BED ENCLOSURE SYSTEM

- Haul more with your RANGER and keep your items or gear protected from the elements
- Builds with Lock & Ride® anchors so it can store flat when not in use
- Top can be used as a tonneau cover

» 2881312

XP 900 '13-18, XP 570 '15-16, **XP 1000 '18**, XP 1000 '17, XP 1000 HL '18, DIESEL '14-17, CREW XP 900 '14-18, CREW XP 570 '15-16, CREW XP 1000 '17-18, CREW DIESEL '16-17, 570 FULL SIZE '17-18



LOCK & RIDE CARGO BOX

- Enough room to store all the tools you need to get the job done
- Internal organizational dividers keep gear from rolling around
- Easily detaches from vehicle

» **2883279**

XP 1000 '18, XP 900 '13-18, XP 570 '15-16, XP 1000 HL '18, XP 1000 '18, XP 1000 '17, DIESEL '15-18, CREW XP 900 '15-18, CREW XP 570 '15-16, CREW XP 1000 '17-18, CREW DIESEL '16-18



RANGER GEAR VAULT

- Rugged roto-molded construction is water-resistant
- Sliding drawer features two adjustable dividers that can be arranged or completely removed to meet your hauling needs
- Designed for a perfect fit in the cargo bed of the Full-Size RANGER, can also be used in other trucks
- Integrated top depressions allow for an exact fit for the Lock & Ride Dog Kennel, Polaris Northstar Coolers (28.4 & 56.8 L), 18.9 L buckets and more
- Two easy-to-pull handles with locking middle handle

» **2882353**

XP 900 '13-18, XP 570 '15-16, XP 1000 '18, XP 1000 '17, XP 1000 HL '18, DIESEL '14-17, CREW XP 900 '14-18, CREW XP 570 '15-16, CREW XP 1000 '17-18, CREW DIESEL '16-17, CREW 570-6 '17, CREW 570 FULL SIZE '18, 570 FULL SIZE '17-18



LOCK & RIDE SPARE TIRE MOUNT

- Be ready for an unexpected flat with a spare that's conveniently along for the ride

» **2881529**

XP 900 '13-18, XP 570 '15-16, XP 1000 HL '18, XP 1000 '17, CREW XP 900 '14-18, CREW XP 570 '15-16, CREW XP 1000 '17-18, CREW 570-6 '17, CREW 570 FULL SIZE '18, 570 FULL SIZE '17-18



LOCK & RIDE TOOL RACK

- Carry up to five tools with additional tie-down points
- Attach on the inside or outside of the cargo bed

» **2881533**

XP 900 '13-18, XP 570 '15-16, XP 1000 '18, XP 1000 '17, XP 1000 HL '18, DIESEL '14-17, CREW XP 900 '14-18, CREW XP 570 '15-16, CREW XP 1000 '17-18, CREW DIESEL '13-17, CREW 570 '16-17, CREW 570 FULL SIZE '18, 800 '13-14, 570 FULL SIZE '17-18, CREW 570 FULL SIZE '18, 800 '13-14, 570 FULL SIZE '17-18



LOCK & RIDE

XL STORAGE BOX

- Extra large storage capacity box with lid secured by four rubber clasps
- Includes internal dividers and reversible lid for additional tie-down points
- To secure in cargo bed use: Lock & Ride D-Rings (2881545 and 2 Tie-Down Straps) (2859047-01/2859047-02/2871182)

» **2881128-070**

XP 900 '13-18, XP 570 '15-16, XP 1000 '17-18, XP 1000 HL '18, DIESEL '14-17, CREW XP 900 '14-18, CREW XP 570 '15-16, CREW XP 1000 '17-18, CREW DIESEL '13-17, CREW 570 '16-17, CREW 570 FULL SIZE '18, 800 '13-14, 570 FULL SIZE '17-18, CREW 570 FULL SIZE '18, 800 '13-14, 570 FULL SIZE '17-18



XL SOFT SIDE COOLER

» **2881428**



XL TRAIL BAG

» **2881130**



XL TOOL BAG

» **2881129**



XL POLARIS PURSUIT CAMO RANGE BAG

» **2881131**

LOCK & RIDE CHAINSAW MOUNT

- Can be secured to the outside of the bed wall so your chainsaw is within reach at all times

» **2879354**

XP 900 '13-18, XP 570 '15-16, XP 1000 '18, XP 1000 '17, XP 1000 HL '18, DIESEL '14-17, CREW XP 900 '14-18, CREW XP 570 '15-16, CREW XP 1000 '17-18, CREW DIESEL '13-17, CREW 570 '16-17, CREW 570 FULL SIZE '18, 800 '13-14, 570 FULL SIZE '17-18, CREW 570 FULL SIZE '18, 800 '13-14, 570 FULL SIZE '17-18

FIRE EXTINGUISHER HOLDER

- Only holds a 3.25" (8.25 cm) diameter extinguisher
- Quick release strap allows for easy use

» **2882158**

XP 900 '13-18, XP 570 '15-16, XP 1000 '18, XP 1000 '17, XP 1000 HL '18, DIESEL '14-17, CREW XP 900 '14-18, CREW XP 570 '15-16, CREW XP 1000 '17-18, CREW DIESEL '13-17, CREW 570 '16-17, CREW 570 FULL SIZE '18, 800 '13-14, 570 FULL SIZE '17-18, CREW 570 FULL SIZE '18, 800 '13-14, 570 FULL SIZE '17-18

RIDE & REPAIR ESSENTIALS KIT

» **2881207**
ALL RANGER® MODELS

POLARIS NORTHSTAR COOLER

Polaris Northstar® coolers survive just about anything - from extreme heat to a full-on bear attack. Ice will stay cold for hours on end, and anything inside will stay locked up tight.



POLARIS NORTHSTAR COOLER

99.4 L **NEW** FALL AVAILABILITY

» GRAPHITE • 2883426

» DESERT • 2883392

56.8 L

» **NEW** GRAPHITE 2883425

» DESERT • 2881259

28.4 L

» **NEW** GRAPHITE 2883424

» DESERT • 2881315

18.9 L SOFTSIDE **NEW**

» GRAPHITE • 2883390

TUMBLERS **NEW** NOT SHOWN

» 887 ML • 2883394

» 591 ML • 2883393



28.4, 56.8, 99.4 LITER FEATURES



ComfortCarry Handles

Carry a fully loaded cooler with comfort and ease



TravelLock System

Integrated tie-down cleats easily secure to any off-road vehicle, boat, or truck



EasyOut Drain System

Large, easy-to-open plug for rapid draining



NoSlip Rubber Feet

Firm placement on any surface



PolarWall Insulation

Thick 5 cm insulation ensures premium cooling



IceLock Seal

Airtight gasket along the lid keeps cold air in



POLARIS NORTHSTAR COOLER ACCESSORIES



WIRE BASKET

» **2882185** • 56.8 LITER • SHOWN

» **2882438** • 28.4 LITER



Divider doubles as a cutting board

DIVIDERS

» **2882184** • 56.8 LITER SHOWN

COMES WITH TWO DIVIDERS

» **2882186** • 28.4 LITER

COMES WITH ONE DIVIDER



56.8 LITER
2 ways to partition



28.4 LITER
1 way to partition



SEAT CUSHION

» **2882179** • 56.8 LITER • SHOWN

» **2882507** • 28.4 LITER

COOLER WHEELS

» **2882180** • 56.8 LITER



BOTTLE OPENER

» **2882183**

ALL COOLERS



LOCK & RIDE QUICKSTRAP

» **2882187**

ALL COOLERS, POLARIS GENERAL CARGO BOXES



TIE-DOWN STRAPS

» **2859047-01** • RED

ALL COOLERS

» **2859047-02** • BLACK

ALL COOLERS

THIS SEASON

ELEVATE YOUR PURSUIT

AND LEAVE NOTHING
TO CHANCE

GEAR UP WITH THE RIGHT ACCESSORIES THAT CAN TAKE YOU TO FIND THE NEXT TROPHY.
After you customize your cab with the new *RANGER* Pro Shield™ Cab System, add on the hunting essentials to keep your gear and gun safe across the rugged terrain.

LOCK & RIDE DOG KENNEL

- Drain holes in the bottom
- Rubber feet seamlessly fit in the indentations of the *RANGER*® Gear Vault for a secure fit
- Use the Lock & Ride® QuickStrap to secure to the cargo bed
- Lightweight with a molded handle in the top for easy carrying

» 2882354

XP 900 '13-18, XP 570 '15-16, *XP 1000 '18*, XP 1000 '17, XP 1000 HL '18, EV '15-18, EV LI-ION '18, EV LI-ION '16, ETX '15-16, DIESEL '14-17, CREW XP 900 '14-18, CREW XP 570 '15-16, CREW XP 1000 '17-18, CREW DIESEL '16-17, CREW 570-6 '17, CREW 570-4 '15-18, CREW 570 FULL SIZE '18, 570 '15-18, 570 FULL SIZE '17-18, 500 '17-18



**KOLPIN®
OUTDOORS**

Polaris® is proud to partner with Kolpin Outdoors®, an industry leader in off-road accessories and the premier name in gun boots and mounts. Our exclusive line of Kolpin® accessories are designed to fit and tested to work perfectly with your Polaris *RANGER*®.



IN-CAB GUN MOUNT

- Gives you instant gun access in the field
- Mounts securely to the floor and adjusts up to 45° forward
- Robust, molded gun butt holder at base
- Quick-release barrel straps
- Easily removable
- Accommodates scope-equipped rifles

» 2883263

XP 1000 '18

» 2881537

XP 900 '13-18, XP 570 '15-16, XP 1000 '17, XP 1000 HL '18, EV '15-18, EV LI-ION '18, EV LI-ION '16, ETX '15-16, DIESEL '14-17, CREW XP 900 '14-18, CREW XP 570 '15-16, CREW XP 1000 '17, CREW 570-4 '15-18, 570 '15-18, 500 '17-18



LOCK & RIDE GUN RACK 6

- Adjustable to store guns at an angle or vertical (shown at angle)
- Holds 6 rifles or shotguns securely with soft rubber v-grips
- Stack is secured in place with a soft molded rubber inlay along the bottom of the rack
- Rack can be adjusted into 3 positions based on firearm height

» 2882159

XP 900 '13-18, XP 570 '15-16, *XP 1000 '18*, XP 1000 '17, XP 1000 HL '18, DIESEL '14-17, CREW XP 900 '14-18, CREW XP 570 '15-16, CREW XP 1000 '17-18, CREW DIESEL '16-17, CREW 570-6 '17, CREW 570 FULL SIZE '18, 570 FULL SIZE '17-18



POLARIS® PURSUIT® CAMO SXS FIELD COVER

- Full-coverage camo print cover hides your side-by-side while in the field
- Lightweight material protects your *RANGER*® from inclement weather

» 2882160

XP 900 '13-18, XP 570 '15-16, *XP 1000 '18*, XP 1000 '17, XP 1000 HL '18, GENERAL '16-18, EV '11-18, EV LI-ION '18, EV LI-ION '16, ETX '15-16, DIESEL '14-17, CREW XP 1000 '17, CREW 500-4 '13, 800 '13-14, 570 '14-18, 570 FULL SIZE '17-18, 500 '11-18, 400 '11-14



POLARIS® GUN BOOT® BY KOLPIN®

- Works with shotgun or rifle
- Padded interior, dustproof, water-resistant

» BLACK • 2872677

» MOSSY OAK® BREAK-UP • 2872677-419

FITS POLARIS' LOCK & RIDE® GUN BOOT MOUNT



LOCK & RIDE DUAL GUN BOOT® MOUNT

- Mounted low along the top of the cargo box against the cab
- Securely holds 2 gun boots (sold separately)

» 2877036

XP 900 '13-18, XP 570 '15-16, *XP 1000 '18*, XP 1000 '17, XP 1000 HL '18, DIESEL '14-17, CREW XP 900 '14-18, CREW XP 570 '15-16, CREW XP 1000 '17-18, CREW DIESEL '16-17, CREW 570-6 '17, CREW 570 FULL SIZE '18, 570 FULL SIZE '17-18



RATCHETING RHINO GRIP® XL BY KOLPIN®

» 2881575

ALL *RANGER*® MODELS



LOCK & RIDE RHINO GRIP® XL BY KOLPIN®

» 2881574

ALL *RANGER*® MODELS

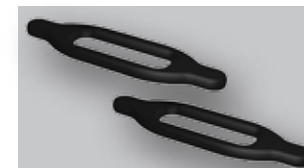

RUBBER STRAPS

» 2881621

ALL *RANGER*® MODELS



LOCK & RIDE DUAL GUN BOOT® MOUNT II

- Mounted low along the top of the cargo box

- Securely holds 2 gun boots (sold separately)

» 2876148-458

XP 900 '13-18, XP 570 '15-16, *XP 1000 '18*, XP 1000 '17, XP 1000 HL '18, DIESEL '14-17, CREW XP 900 '14-18, CREW XP 570 '15-16, CREW XP 1000 '17-18, CREW DIESEL '16-17, CREW 570-6 '17, CREW 570 FULL SIZE '18, 570 FULL SIZE '17-18



LOCK & RIDE SINGLE GUN BOOT® MOUNT

- Mounted high to accommodate dog kennels and other cargo (not included)

- Securely holds 1 boot (sold separately)

» 2881049

XP 900 '13-18, XP 570 '15-16, *XP 1000 '18*, XP 1000 '17, XP 1000 HL '18, DIESEL '14-17, CREW XP 900 '14-18, CREW XP 570 '15-16, CREW XP 1000 '17-18, CREW DIESEL '16-17, CREW 570-6 '17, CREW 570 FULL SIZE '18, 570 FULL SIZE '17-18

STAY ON GUARD

THE BEST WAY TO PROTECT your RANGER® is with durable, rugged Polaris® bumpers and guards. Engineered for heavy-duty use, these items are your best line of defense against unexpected encounters, and will keep you going strong even when on the toughest job.



ALL POLARIS ENGINEERED™ BUMPERS HAVE **BUILT-IN MOUNTING LOCATIONS** FOR LIGHTS. NO DRILLING NECESSARY.



ROCK GUARD WITH STEP **NEW**

- Reliable, hard-working protection for edges of vehicle
- Integrated step with boot scraper
- Mounts directly to the frame, instead of underneath, for maximum ground clearance
- Steel construction
- Black e-coat and durable black powdercoated finish

» 2882530
XP 1000 '18

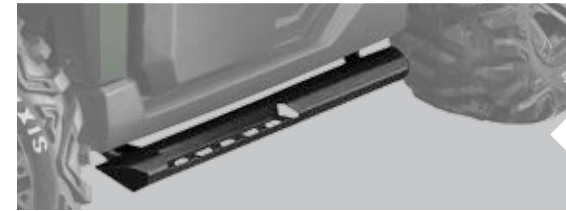

XP ROCK GUARD WITH STEP

- Durable, stamped plate steel construction
- Provides additional protection to side of vehicle
- Integrated boot scraper helps keep interior clean

» 3-SEAT • 2878843
XP 900 '13-18, XP 570 '15-16, XP 1000 '17, XP 1000 HL '18, DIESEL '14-17

» 6-SEAT • 2879622
CREW XP 900 '14-18, CREW XP 570 '15-16, CREW XP 1000 '17-18, CREW DIESEL '16-17



STANDARD BRUSHGUARDS

PERFECT FOR: **INCREASED PROTECTION AROUND LIGHTING AND FENDERS**

FRONT



INSTALLS DIRECTLY TO STOCK BUMPER

NEW

1 3/4" (4.4 CM) DIAMETER STEEL TUBE CONSTRUCTION

FRONT



INSTALLS DIRECTLY TO STOCK BUMPER

TOP SELLER

1 3/4" (4.4 CM) DIAMETER STEEL TUBE CONSTRUCTION

REAR



CAN BE USED IN CONJUNCTION WITH A TOW HITCH

NEW

» FRONT • 2882531
XP 1000 '18

» REAR • 2882529

REAR



» FRONT • 2878839

» REAR • 2878840

XP 900 '13-18, XP 570 '15-16, XP 1000 '17, XP 1000 HL '18, DIESEL '14-17, CREW XP 900 '14-18, CREW XP 570 '15-16, CREW XP 1000 '17-18, CREW DIESEL '16-17

EXTREME BRUSHGUARDS

PERFECT FOR: **MAXIMUM PROTECTION, INTEGRATED MOUNTING POINTS**

FRONT

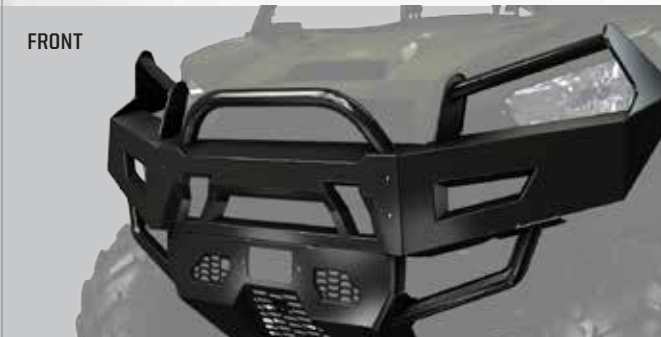

1 3/4" (4.4 CM) DIAMETER STEEL TUBE CONSTRUCTION

REAR

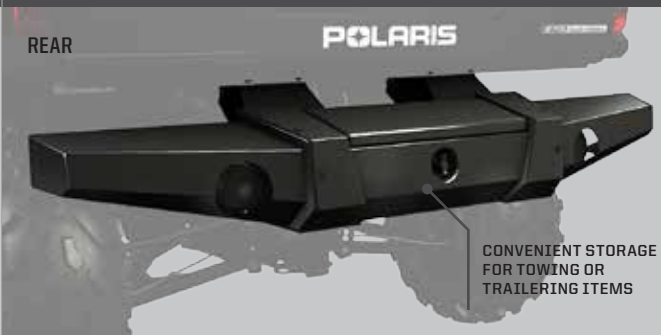

CONVENIENT STORAGE FOR TOWING OR TRAILERING ITEMS

» FRONT • 2879201

» REAR • 2878842

XP 900 '13-18, XP 570 '15-16, XP 1000 '17, DIESEL '14-17, CREW XP 900 '14-18, CREW XP 570 '15-16, CREW XP 1000 '17-18, CREW DIESEL '16-17

HMW SKID PLATE

- Strong, 3/4" (6.35 mm) thick lightweight HMW (high molecular weight) polyethylene construction withstands off-road impacts, protecting vehicle components

- Molded specifically for the RANGER XP® underbody for sure fit & low-profile presence

- Bolts quickly & easily into designated, integrated installation locations

» 2879686

XP 900 '13-18, XP 570 '15-16, XP 1000 '17, XP 1000 HL '18, DIESEL '14-17,

HMW A-ARM GUARDS

- Strong, 3/4" (6.35 mm) thick, durable, lightweight HMW (high molecular weight) polyethylene construction helps protect against off-road impacts

- Molded specifically for the RANGER XP® front suspension for a sure fit & low-profile presence

- Easy bolt-on design with mounting hardware included

» **NEW** FRONT • 2882784

XP 1000 '18

» FRONT • 2880553

» REAR • 2880554

XP 900 '13-18, XP 570 '15-16, XP 1000 '17, XP 1000 HL '18, DIESEL '14-17, CREW XP 900 '14-18, CREW XP 570 '15-16, CREW XP 1000 '17-18, CREW DIESEL '16-17

» **NEW** 2882787

XP 1000 '18

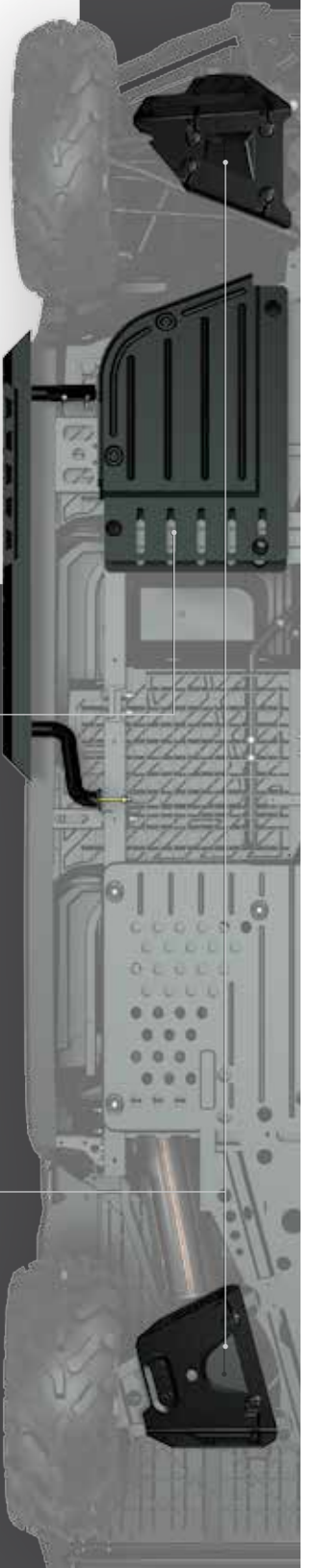

ANY JOB ANY ACCESSORY



LOCK & RIDE BOOMLESS UTILITY SPRAYER - 227 LITERS

» 2879799 •

XP 900 '13-18, XP 570 '15-16, XP 1000 '17, XP 1000 HL '18, DIESEL '14-17, CREW XP 900 '14-18, CREW XP 570 '15-16, CREW XP 1000 '17-18, CREW DIESEL '13-17, CREW 570-6 '17, CREW 570 FULL SIZE '18, 800 '13-14, 570 FULL SIZE '17-18



A. T-POST POST HAULER

- Organize and secure up to 12 T-post type fence posts
- Receiver hitch-mounted base and under-box bracket supports and secures to your *RANGER*

» 2882192

XP 900 '13-18, XP 570 '15-16, XP 1000 '17, XP 1000 HL '18, DIESEL '14-17, CREW XP 900 '14-18, CREW XP 570 '15-16, CREW XP 1000 '17-18

B. LOCK & RIDE WIRE SPOOLER

- Designed for a variety of wire spool sizes, does not work with barbed wire due to size of spools
- Manual crank operated or accepts cordless drill for even easier operation
- Includes post for mounting a hydraulic or manual fence post driver

» 2882157

XP 900 '13-18, XP 570 '15-16, XP 1000 '17, XP 1000 HL '18, DIESEL '14-17, CREW XP 900 '14-18, CREW XP 570 '15-16, CREW XP 1000 '17-18, CREW 570-6 '17, CREW 570 FULL SIZE '18, 570 FULL SIZE '17-18

» **NEW!** 2883280

XP 1000 '18

CARGO BOX LIFT

» 2882291

XP 900 '13-18, XP 570 '15-16, XP 1000 HL '18, DIESEL '15-17, CREW XP 570 '15-16, CREW XP 1000 '17-18, CREW DIESEL '16-17

» 2882895

XP 1000 '18

BUILD YOUR HITCH SYSTEM

A. 3-POINT HITCH

- 3-Point Hitch System accommodates an array of attachments
- Rocker-actuated lift system applies 300 lbs. (136 kg) of downward force, improving attachment performance

» 2881567

XP 900 '13-18, XP 570 '15-16, XP 1000 '18, XP 1000 '17, XP 1000 HL '18, DIESEL '15-17, CREW XP 900 '15-18, CREW XP 570 '15-16, CREW XP 1000 '17-18, CREW DIESEL '16-17

B. 3-POINT HITCH SYSTEM FRAME SUPPORT BAR

- Add frame support and stability
- Transfers torque load from the hitch to your frame
- Easy attachment
- Required for the 3-Point Hitch System to function

» 2881655

XP 900 '13-18, XP 570 '15-16, XP 1000 '17, XP 1000 HL '18, DIESEL '14-17, CREW XP 900 '14-18, CREW XP 570 '15-16, CREW XP 1000 '17-18

» 2883461

XP 1000 '18

C. ACCESSORY TOOL BAR

- Change between several implements in just minutes
- Mounts to the 3-Point Hitch

» 2881568

XP 900 '13-18, XP 570 '15-16, XP 1000 '18, XP 1000 '17, XP 1000 HL '18, DIESEL '15-17, CREW XP 900 '15-18, CREW XP 570 '15-16, CREW XP 1000 '17-18, CREW DIESEL '16-17

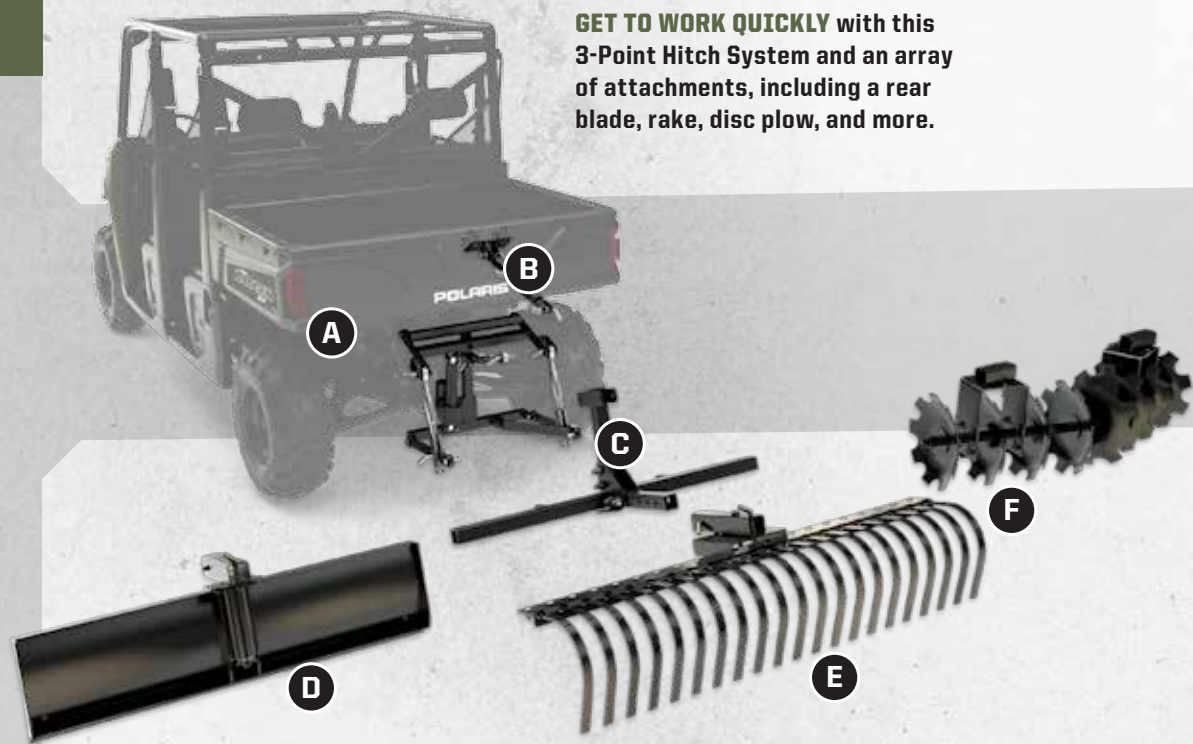

GET TO WORK QUICKLY with this 3-Point Hitch System and an array of attachments, including a rear blade, rake, disc plow, and more.

ADD ACCESSORIES

D. 122 CM REAR BLADE

- Durable 48" x 13" (122 x 33 cm) steel blade with replaceable wear bar
- Five-position angle adjustment
- Easy single-pin mounting and detachment

» 2881571

XP 900 '13-18, XP 570 '15-16, XP 1000 '18, XP 1000 '17, XP 1000 HL '18, DIESEL '15-17, CREW XP 900 '15-18, CREW XP 570 '15-16, CREW XP 1000 '17-18, CREW DIESEL '16-17

E. 152 CM LANDSCAPE RAKE

- Heavy-duty, hardened 1 5/16" (33.3 mm) landscape tines
- Five-position adjustment for desired results
- Wide 60" (152 cm) swath for maximum efficiency

» 2881570

F. 137 CM DISC PLOW

- Live axle features two gangs of four cutting discs each
- Five adjustment angles to accommodate different soil types and conditions
- Rugged steel construction and wide 54" (137 cm) design

» 2881569

THE *RANGER*® 570 FULL-SIZE builds on its legendary reputation for getting the job done. With the industry's most complete lineup of Polaris Engineered Accessories™, it's ready for anything your work demands.



SPORT ROOF

TOP SELLER

- Lightweight, rugged polyethylene construction

» 2877946

XP 570 '16, 570 FULL SIZE '17-18

- Offers protection from sun and rain

» CREW • 2878755

CREW XP 900 '14, CREW XP 570 '16, CREW DIESEL '13-14, CREW 570-6 '17, CREW 570 FULL SIZE '18, 800 '13-14

BIMINI SOFT TOP

- Tight-fitting canvas soft top with easy on/off design
- Lightweight 600 denier, solution-dyed polyester construction

» 2876963-067

XP 570 '16, 570 FULL SIZE '17-18

CANVAS ROOF/REAR PANEL

- Constructed from premium, mold-resistant polyester with UV stabilizers
- Durable, heat-sealed vinyl window for crack resistance

» 2876961-067

XP 570 '16

CREW DIESEL '13-14, CREW 570-6 '17, CREW 570 FULL SIZE '18, 800 '12-14

» 2877833-067

CREW XP 900 '14, CREW XP 570 '16,

POLY WINDSHIELD

- Optical-grade, 5.9 mm-thick polycarbonate for outstanding protection and visibility

» GENERAL PURPOSE • 2876958

XP 570 '16, CREW XP 900 '14, CREW DIESEL '13-14, 800 '13-14, 570 FULL SIZE '17-18

» HARD COAT • 2879489

CREW XP 900 '14, CREW XP 570 '16, CREW DIESEL '13-14, CREW 570-6 '17, CREW 570 FULL SIZE '18, 800 '13-14

HALF WINDSHIELD

- Durable, optical-grade 4.5 mm-thick polycarbonate for impact-resistance
- Half-height design delivers improved airflow for hot/dusty conditions
- Retains sporty, rugged look

» 2878756

XP 570 '16, CREW XP 900 '14, CREW XP 570 '16, CREW DIESEL '13-14, CREW 570-6 '17, CREW 570 FULL SIZE '18, 800 '13-14, 570 FULL SIZE '17-18

POLY REAR PANEL

- Constructed from thick, impact resistant polycarbonate
- Delivers protection from the elements and a quieter ride
- Scratch-resistant for years of clear vision
- Contoured design eliminates perimeter framework for full rearward visibility

» 2878165

XP 570 '16, CREW XP 900 '14, CREW XP 570 '16, CREW DIESEL '13-14

RANGER® CANVAS DOORS

- Constructed from premium, mold-resistant polyester with UV stabilizers
- Durable, heat-sealed vinyl window for crack resistance
- Zip-down windows for adjustable ventilation

» 2876962-067

XP 570 '16

BRUSHGUARDS

- Provides frontal impact resistance and headlight protection
- Can be used with accessory winch or plow system
- Durable, scratch-resistant black powdercoated finish
- Does not interfere with rear cargo drop gate

» FRONT • 2881662

» REAR • 2881661

XP 570 '16, CREW XP 570 '16, CREW 570-6 '17, CREW 570 FULL SIZE '18, 570 FULL SIZE '17-18



CAB SYSTEMS p. 52



WINCHES p. 69

Never transport a loaded firearm. Verify firearm is unloaded prior to mounting. Please refer to local laws and regulations regarding the requirements for the legal transport of firearms.

MID-SIZE

POWER, COMFORT AND LEGENDARY RANGER® CAPABILITY combine to haul more, tow more and do more when you need it the most. Whether it is on your property, on the hunt, on the trail or at the work site, a mid-size RANGER® equipped with Polaris Engineered Accessories™ takes on all tasks.

TIRES p. 78



STORAGE p. 64

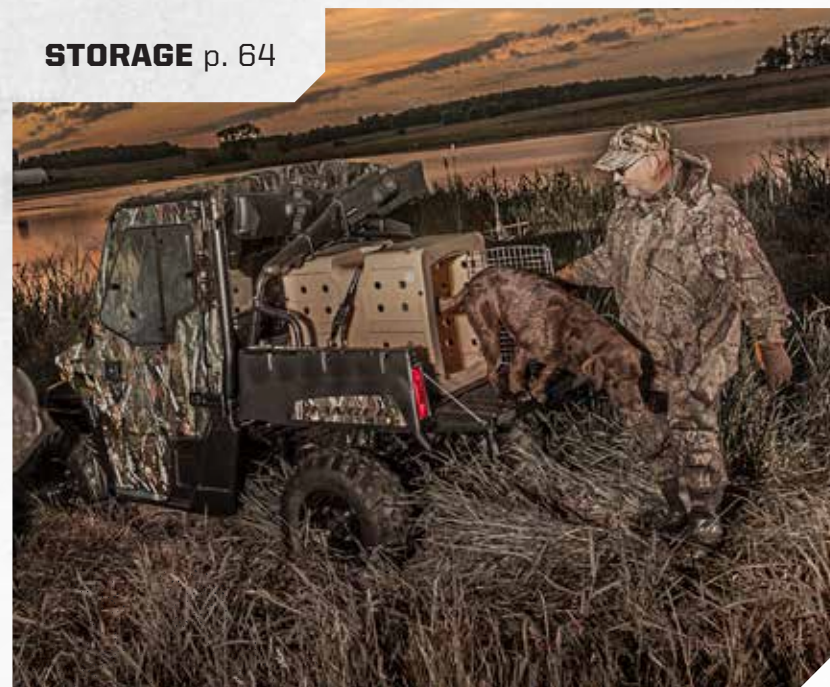

LIGHTING p. 84



CAB COMFORT p. 62



DO MORE FOR YOUR PROPERTY ANY SEASON



NO MATTER WHAT THE DAY CALLS FOR, WORK IN COMFORT with Polaris Engineered™ cab components. Add a roof, windshield, rear panel and doors for a complete cab system. With Lock & Ride® capability, cab components can be easily added or removed to reconfigure your **RANGER®** for specific conditions or the season.

FEATURED **RANGER CREW® 570-4** CAB COMPONENTS

- A.** LOCK & RIDE FULL WINDSHIELD - GLASS 2881783
- B.** LOCK & RIDE SPORT ROOF CREW - POLY - BLACK 2883238
- C.** LOCK & RIDE REAR PANEL - GLASS 2879965
- D.** LOCK & RIDE ZIP WINDOW DOORS - CANVAS - BLACK 2879963
- E.** LOCK & RIDE ZIP WINDOW REAR DOORS - CANVAS - BLACK 2879964



TAKE CONTROL OF ANY CONDITION

Add four-season versatility and unmatched comfort to your RANGER® with a Polaris® Cab System. Built around the profile tube frame and designed exclusively with, and for, your machine, Polaris Engineered™ cab components install faster, seal better and keep you more protected.

PROFILE TUBE CAB FRAME



UNPRECEDENTED INTEGRATION STARTS AT THE FRAME

Polaris Engineered Accessories™ are developed in lockstep with your RANGER®, delivering unparalleled integration and functionality. The mounting locations are built right into the cab frame, ensuring all cab components fit perfectly, seal tightly and install easily.



KEEP GOING ALL YEAR ROUND

Using the RANGER® chassis channel design, every cab system features a 360° gasket seal to keep the elements out.



90° TWIST-OF-A-HANDLE INSTALLATION

EASY ON EASY OFF

Once mounted, each Lock & Ride® component of your Polaris® Cab System conveniently installs or removes in seconds with no digging in the toolbox.



CLAMP INSTALLATION

LOCKED

UNLOCKED

BUILD ALL-TERRAIN AND
ALL-SEASON PROTECTION
 THAT NEVER QUILTS

GAIN ALL-SEASON PROTECTION, COMFORT AND CONFIDENCE for the field, the hunt or beyond with a Polaris® Cab System designed for your *RANGER*®. With hundreds of ways to configure by mixing and matching roofs, windshields, rear panels and doors, the perfect solution for your needs awaits.



ROOFS P. 56



WINDSHIELDS P. 58 & 60



REAR PANELS P. 59 & 61



DOORS P. 57



Never transport a loaded firearm. Verify firearm is unloaded prior to mounting. Please refer to local laws and regulations regarding the requirements for the legal transport of firearms.



POLARIS ENGINEERED™
ADVANTAGES



SEALED COVERAGE

Just as roof shingles overlap for seamless coverage, roofs extend over other cab components to add even more protection against the elements, delivering the best fit and seal.

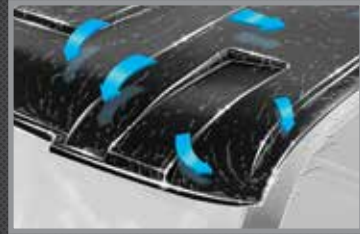

KEEP MOISTURE MOVING

Keep precipitation moving with integrated roof water channels that direct water away from the cab, even when you're stationary.



REVOLUTIONARY INSTALLATION

Lock & Ride® roofs install directly into mounting points in the cab frame, and are easily installed or removed without tools.

OVERHEAD PROTECTION

TO SHIELD AGAINST DRIVING RAIN OR THE BLISTERING SUN, a roof is the first must-have of the Polaris Engineered Accessories™ line-up. Choose from poly or steel and know that you are protected from the elements with a seamless integrated roof.

POLY Lightweight, durable and impact-resistant. A poly roof can take the abuse of a tight trail and still protect.



LOCK & RIDE SPORT ROOF - POLY TOP SELLER

- Provides shade, superior overhead protection
 - Tough injection-molded design resists distortion from the elements
 - Polaris Pursuit® Camo offers effective visual camouflage in the field
- » 2-SEAT BLACK • 2883236 •
 - » 2-SEAT POLARIS PURSUIT® CAMO • 2883237 •
EV LHON '18, EV LI ION '16, EV '15-18, ETX '15-16, 570 '15-18, 500 '17-18
 - » CREW BLACK • 2883238 •
CREW 570-4 '15-18

STEEL For the ultimate in strength and protection.

LOCK & RIDE HD ROOF - STEEL

- Stout 12-gauge steel construction
 - Powdercoated finish for scratch and corrosion resistance
 - Interior fabric liner provides sound reduction
- » 2-SEAT • 2879954 •
EV '15-18, EV LI-ION '18, EV LI ION '16, ETX '15-16, 570 '15-18, 500 '17-18



COMPLETE YOUR CAB SYSTEM

POLY Heavy-duty tube frames with hard molded shells and cab seal systems for the best all-weather protection

FRONT DOORS



6-position adjustments for optimal ventilation options

HINGED WINDOW DOORS - POLY

- Hinged window for customizable ventilation
- » BLACK • 2882247 •
- » POLARIS PURSUIT® CAMO • 2880636 •
EV '15-18, EV LI-ION '18, EV LI ION '16, ETX '15-16, 570 '15-18, 500 '17-18

CANVAS Lightweight, durable protection with adjustable zipper ventilation and see-through bottom panel.

FRONT DOORS



PVC windows zip open to provide ventilation

Interior

ZIP WINDOW DOORS - CANVAS - BLACK

- Durable UV-protected vinyl material
 - Zippered window for customizable ventilation
 - Roll down and secure the window for full ventilation
- » 2879963 •
EV '15-18, EV LI-ION '18, EV LI ION '16, ETX '15-16, CREW 570-4 '15-18, 570 '15-18, 500 '17-18

REAR DOORS



PVC windows zip open to provide ventilation

Interior

ZIP WINDOW REAR DOORS - CANVAS - BLACK

- Durable UV-protected vinyl material
 - Zippered window for customizable ventilation
 - Roll down and secure the window for full ventilation
- » 2879964 •
CREW 570-4 '15-18

POLARIS ENGINEERED™
ADVANTAGES



PREMIUM FEATURES

Automotive-like finish, solid latches, storage and more.

QUIETER AT IDLE

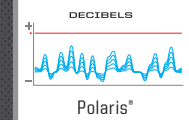

SOUND DAMPENING DOOR LINERS

Select doors come standard with sound-absorbing liners to help reduce in-cab noise.



UNPRECEDENTED VENTILATION OPTIONS

Choose from multiple window options –including hinged and zip-down windows. This allows you to find the perfect amount of ventilation and temperature regulation.



REVOLUTIONARY INSTALLATION

Adding or removing your doors is as simple as dropping them in and pulling them off. Easy, convenient, and takes only seconds to remove the restraint rubber strap.

ULTIMATE CLARITY WITH GLASS

FOR THE ULTIMATE IN SCRATCH RESISTANCE AND CLARITY, nothing beats glass. It has the most optical clarity of any windshield material, and cuts the wind and harsh elements. Couple a rear panel with your windshield to reduce the dust swirl for a clean ride.



ADD ALL-WEATHER VISIBILITY WINDSHIELD WIPER & WASHER SYSTEM
P. 62

TEMPERED SAFETY GLASS

For the ultimate in scratch resistance, tempered safety glass is the top choice. Optically, it is the clearest glass available, and because it is tempered, it's shatterproof.

POLARIS ENGINEERED™ ADVANTAGES

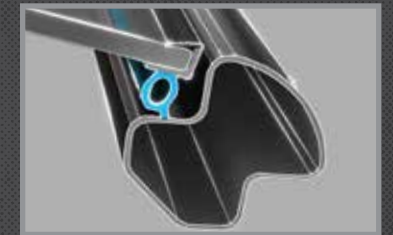

AIRTIGHT GASKET SEAL

RANGER® windshields feature a 360° gasket seal preventing moisture and dust from entering the cab.



MULTI-FUNCTION FEATURES

Venting options are useful for controlling airflow into the cab. This allows you to regulate the temperature inside. A low-profile exterior framework on the windshields gives an unobstructed field of vision.



REVOLUTIONARY INSTALLATION

Every Lock & Ride® windshield utilizes a unique clamp that secures your windshield with the perfect amount of hold for rough trail conditions, yet still allows for easy, tool-less removal.

GLASS WINDSHIELDS



TIP-OUT WINDSHIELD - GLASS

- Made of strong, optical-grade laminate safety glass
- Provides optimal visibility and the best protection from wind, inclement weather and off-road hazards
- Minimal perimeter framework for a low profile and full visibility
- Tip-out feature lets riders adjust the windshield to an open position that allows riders to enjoy airflow in the cab

» 2881784
EV '15-18, EV LI-ION '18, EV LI ION '16, ETX '15-16, CREW 570-4 '15-18, 570 '15-18, 500 '17-18



LOCK & RIDE FULL WINDSHIELD - GLASS

- Provides the highest level of scratch resistance

» 2881783
EV '15-18, EV LI-ION '18, EV LI ION '16, ETX '15-16, CREW 570-4 '15-18, 570 '15-18, 500 '17-18

REAR PANEL



REDUCE IN-CAB DUST SWIRL BY ADDING A REAR PANEL
With a windshield and roof installed, turbulent air develops behind the cab. Add a rear panel to reduce dust intrusion from this swirl.



LOCK & RIDE REAR PANEL - GLASS

- Durable, tempered laminate glass provides a high level of scratch resistance

» 2879965
EV '15-18, EV LI-ION '18, EV LI ION '16, ETX '15-16, CREW 570-4 '15-18, 570 '15-18, 500 '17-18

DURABLE POLY PROTECTION

LIGHT AND FLEXIBLE, poly is impact-resistant, providing long-term value and protection. Whether you choose hard coat, a general poly windshield or rear panel, you can hit the trail or job site with confidence, protection and durability.



ADD ALL-WEATHER VISIBILITY
WINDSHIELD WIPER & WASHER SYSTEM
P. 62

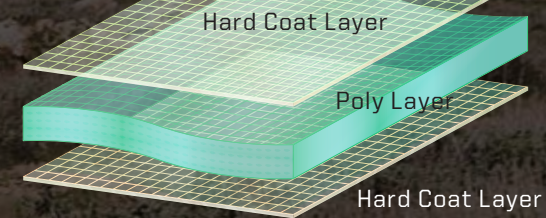

HARD COAT POLY

Poly windshields covered by hard coat provide **30x MORE** scratch resistance than any standard poly windshields.

POLARIS ENGINEERED™ ADVANTAGES

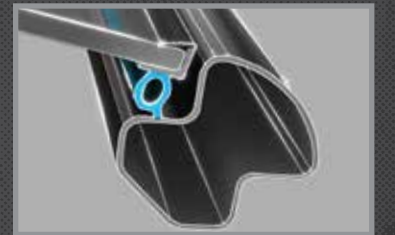

AIRTIGHT GASKET SEAL

RANGER® windshields feature a 360° gasket seal, preventing moisture and dust from entering the cab.

POLY WINDSHIELDS



LOCK & RIDE FLIP-DOWN WINDSHIELD - HARD COAT POLY

- 2 venting options: fully sealed or flip-down/remove upper half for some protection with maximum ventilation

» 2882178

EV '15-18, EV LI-ION '18, EV LI-ION '16, ETX '15-16, CREW 570-4 '15-18, 570 '15-18, 500 '17-18



NEW TOP SELLER

LOCK & RIDE FULL WINDSHIELD - HARD COAT POLY

- Durable, optical-grade, 5.9mm-thick polycarbonate offers outstanding rider protection & visibility
- Windshield has minimal perimeter framework for full visibility

» 2883319

EV '15-18, EV LI-ION '18, EV LI-ION '16, ETX '15-16, CREW 570-4 '15-18, 570 '15-18, 500 '17-18



NEW

LOCK & RIDE VENTED WINDSHIELD - HARD COAT POLY

- Frameless design for maximum visibility
- Added vents for airflow on a hot day or defrosting on a cold day

» 2883342

EV LI-ION '18, EV LI-ION '16, EV '15-18, ETX '15-16, CREW 570-4 '15-18, 570 '15-18, 500 '17-18



NEW

LOCK & RIDE FULL WINDSHIELD - POLY

- Durable, optical-grade, 5.9 mm thick polycarbonate offers outstanding rider protection & visibility
- Windshield has minimal perimeter framework for full visibility

» 2883318

EV '15-18, EV LI-ION '18, EV LI-ION '16, ETX '15-16, CREW 570-4 '15-18, 570 '15-18, 500 '17-18



LOCK & RIDE HALF WINDSHIELD - POLY

- Strong, durable polycarbonate half windshield delivers a combination of protection & airflow into the cab
- Half windshield offers protection from rain, sleet, spray, & off-road hazards

» 2883320

EV '15-18, EV LI-ION '18, EV LI-ION '16, ETX '15-16, CREW 570-4 '15-18, 570 '15-18, 500 '17-18

REAR PANELS



REDUCE IN-CAB DUST SWIRL BY ADDING A REAR PANEL
With a windshield & roof installed, turbulent air develops behind the cab. Add a rear panel to reduce dust intrusion from this swirl.



LOCK & RIDE REAR PANEL - POLY **TOP SELLER**

- Strong, 5.9 mm thick polycarbonate provides outstanding impact and scratch resistance

» 2879812

EV '15-18, EV LI-ION '18, EV LI-ION '16, ETX '15-16, CREW 570-4 '15-18, 570 '15-18, 500 '17-18

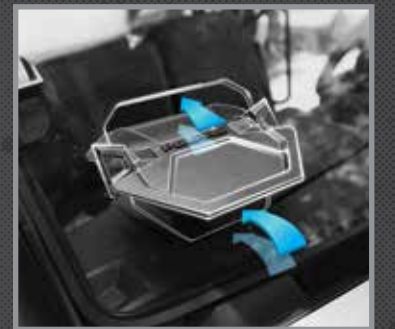

VENTING OPTIONS

Venting options are useful for controlling airflow into the cab. This allows you to regulate the temperature inside.



REVOLUTIONARY INSTALLATION

Every Lock & Ride® windshield utilizes a unique clamp that secures your windshield with the perfect amount of hold for rough trail conditions, yet still allows for easy, tool-less removal.

CONVENIENCE FEATURES

LOOK & RIDE CAB SEAL SYSTEM

- » **2 SEAT • 2879385**
570/500/ETX '17-18, LI-HON EV & EV '15-18
- » **CREW - REAR • 2879657**
CREW 570 '15-18

EPS SYSTEM (ELECTRIC POWER STEERING)

- Enjoy smooth, easy, precise, responsive automotive-quality power steering
- EPS provides a light steering feel in all situations, including low-speed maneuvering through challenging terrain
- » **2879970**
CREW 570-4 '15-18, 570 '15-18, 500 '17-18

HORN

- » **2879273**
EV LHON '18, EV LHON '16, EV '15-18, ETX '15-16, CREW 570-4 '15-18, 570 '15-18, 500 '17-18, '14

AUXILIARY BATTERY KIT

- Recommended to use up to two batteries
- » **2880555**
EV '15-18, EV LI-ION '18, EV LI ION '16
- » **2879031**
EV '14 AND PRIOR

REMOTE GARAGE DOOR OPENER BY HOMELINK®

- » **2882082**
EV '15-18, EV LHON '18, EV LI ION '16, ETX '15-16, CREW 570-4 '15-18, 570 '15-18, 500 '17-18

REVERSE WARNING ALERT

- » **2880631**
EV '15-18, EV LI-ION '18, EV LI ION '16, ETX '15-16, CREW 570-4 '15-18, 570 '15-18, 500 '17-18



PROTECT YOUR RIDE

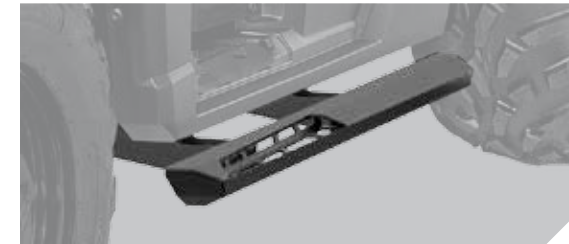

ROCK GUARDS

- Durable, stamped plate steel construction
- Provides additional protection for side of vehicle
- Integrated boot scraper helps keep interior clean
- » **2879974**
EV '15-18, EV LI-ION '18, EV LI ION '16, ETX '15-16, 570 '15-18, 500 '17-18

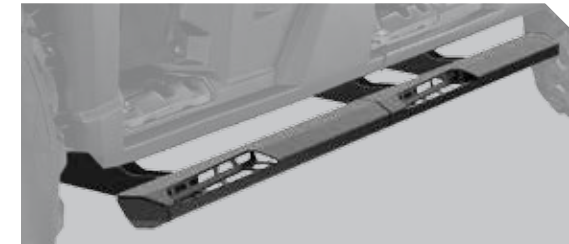

ROCK GUARDS CREW

- » **2880333**
CREW 570-4 '15-18

FIELD TESTED INTERIOR

ADD SUPERIOR ALL-WEATHER FUNCTIONALITY and comfort to your *RANGER*® with premium Polaris Engineered Accessories™. Keep warm on the coldest of days with a heater kit and improve visibility with a Windshield Wiper and Washer System or Large Rear View Mirror.



8-VENT HEATER & DEFROST SYSTEM

- » **2879967**
CREW 570-4 '17-18, 570 '17-18, 500 '17



LARGE REAR VIEW MIRROR TOP SELLER

- » **2879969**
EV LHON '18, EV LHON '16, EV '15-18, ETX '15-16, CREW 570-4 '15-18, 570 '15-18, 500 '17-18

WINDSHIELD WIPER & WASHER SYSTEM

- » **2879968**
EV '15-18, EV LI-ION '18, EV LI ION '16, ETX '15-16, CREW 570-4 '15-18, 570 '15-18, 500 '17-18

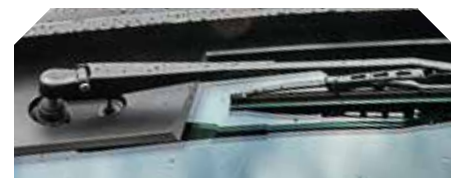

STANDARD BRUSHGUARDS

PERFECT FOR: INCREASED PROTECTION AROUND LIGHTING AND FENDERS

FRONT



REAR



- » **FRONT • 2879973 •**
EV LHON '18, EV LI ION '16, EV '15-18, ETX '15-16, 570 '15-18, 500 '17-18
- » **REAR • 2879972 •**

3.2 CM DIAMETER STEEL TUBE CONSTRUCTION

HMW A-ARM GUARDS

- Lightweight HMW (high molecular weight) polyethylene construction protects against off-road impacts
- Molded specifically for the *RANGER* front suspension
- Mounting hardware included

SIDE	PART NUMBER	PRICE
FRONT	2880550	»
REAR	2880551	»

EV '15-18, EV LI-ION '18, EV LI ION '16, ETX '15-16, CREW 570-4 '15-18, 570 '15-18, 500 '17-18





THE RIGHT TOOLS GET MORE DONE

LOCK & RIDE

EXCLUSIVE AND AVAILABLE ON ALL POLARIS® VEHICLES, LOCK & RIDE® ACCESSORIES LET YOU QUICKLY CHANGE FROM ONE TASK TO ANOTHER WITH HUNDREDS OF OPTIONS.

WITH THE FLIP OF A LEVER, LOCK & RIDE® PLUNGERS USE OUTWARD PRESSURE TO EXPAND FOR A SECURE FIT.

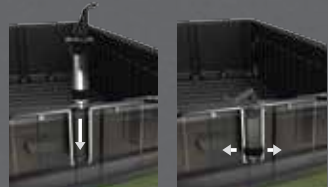

LOCK & RIDE TIP-DOWN HEADACHE RACK

- Tip-down feature converts from rear cab protection to versatile bed rack
- Designed to accept multiple accessories, including coolers, storage boxes and more

» 2879976

EV '15-18, EV LHON '18, EV LI ION '16, ETX '15-16, CREW 570-4 '15-18, 570 '15-18, 500 '17-18

LOCK & RIDE CARGOMAX SYSTEM

- Comes standard with a support bar that ties the two sides together for a sturdy cargo hold
- Adjustable utility hooks provide more options for hanging tools, cords or gear
- Two sides and a support bar included

» 2882177

EV LI-ION '18, EV LI ION '16, EV '15-18, ETX '15-16, CREW 570-4 '15-18, 570 '15-18, 500 '17-18

LOCK & RIDE BED RAILS

- Heavy-duty steel construction with a rugged powdercoat finish
- Features several additional tie-down options
- Works with Tip-Down Headache Rack

» 2882053

EV LI-ION '18, EV LI ION '16, EV '15-18, ETX '15-16, CREW 570-4 '15-18, 570 '15-18, 500 '17-18



LOCK & RIDE BED EXTENDER/DIVIDER

- Installs in any location in the box to secure any cargo
- Use it to extend or divide the cargo box

» 2879977

EV '15-18, EV LI-ION '18, EV LI ION '16, ETX '15-16, CREW 570-4 '15-18, 570 '15-18, 500 '17-18



LOCK & RIDE CARGO BOX

- Rugged roto-molded construction locks for security and is water-resistant
- Low-profile design retains additional hauling capacity on top of vault
- Sliding drawer features foam padding and adjustable dividers
- Fits perfectly in the bed of your RANGER®, pickup box or full-size SUV

» 2877033

EV '11-18, EV LI-ION '18, EV LI ION '16, ETX '15-16, CREW 570-4 '14-18, CREW 500-4 '13, 800 '13-14, 570 '14-18, 500-4 '11, 500 '11-18, 400 '11-14

CARGO BED MAT

- Non-slip surface to better secure loads
- Protect the cargo bed from scratches and scuffs
- Lifts out & is easy to clean
- Can be cut to access factory tie-down cleats

» 2881485

EV '11-18, EV LI-ION '18, EV LI ION '16, ETX '15-16, CREW 570-4 '14-18, CREW 500-4 '13, 800 '13-14, 570 '14-18, 500-4 '11, 500 '11-18, 400 '11-14



LOCK & RIDE XL STORAGE BOX

- Extra large storage capacity box with lid secured by four rubber clasps
- Includes internal dividers and reversible lid
- Use with internal storage bags to organize your gear
- Dimensions: 94 x 41 x 53 cm

» 2881128-070

EV LI-ION '18, EV LI ION '16, EV '11-18, ETX '15-16, CREW 570-4 '14-18, CREW 500-4 '13, 800 '12-14, 570 '14-18, 500-4 '11-12, 500 '11-18, 400 '11-14

Insert up to 3 XL accessory bags in box for additional organized storage



XL SOFT SIDE COOLER

» 2881428

XL TRAIL BAG

» 2881130

XL TOOL BAG

» 2881129

XL POLARIS® PURSUIT® CAMO RANGE BAG

» 2881131



FIRE EXTINGUISHER HOLDER

- Quick-release strap allows for easy access

» 2882158

EV LI-ION '18, EV LI ION '16, EV '15-18, ETX '15-16, CREW 570-4 '15-18, 570 '15-18, 500 '17-18



TIE-DOWN RATCHET STRAPS

- » RED • 2859047-01
- » BLACK • 2859047-02



RIDE & REPAIR ESSENTIALS KIT

- » 2881207
- ALL RANGER® MODELS



LOCK & RIDE CHAINSAW MOUNT

» 2879354

EV LI-ION '18, EV LI ION '16, EV '11-18, ETX '15-16, CREW 570-4 '14-18, CREW 500-4 '13, 800 '13-14, 570 '14-18, 500-4 '11, 500 '11-18, 400 '11-14



UNDER SEAT STORAGE BOX

- » 2880046
- 570/500/ETX '15-17, LI-ION EV & EV '15-17, CREW 570 '15-17

WHEN ON THE HUNT ELEVATE YOUR GAME



KOLPIN
OUTDOORS

Polaris® is proud to partner with Kolpin Outdoors®, an industry leader in off-road accessories and the premier name in gun boots and mounts. Our line of Kolpin® accessories is designed to fit and tested to work perfectly with your Polaris RANGER®.

MID-SIZE HUNT

ELEVATE YOUR GAME with Lock & Ride® hunting gear for your RANGER®. Prepare yourself for the pursuit by keeping your gear secure, organized and easily accessible for the day ahead.

LOCK & RIDE DOG KENNEL

- High-tension spring door opens from either side for versatility and removal
- Drain holes in the bottom
- Rubber feet seamlessly fit in the indentations of the RANGER® Gear Vault for a secure fit
- Lightweight with a molded handle in the top for easy carrying
- Ideal for medium or large breed hunting dogs and family pets
- Measures 86 x 61 cm, allowing you to fit two side-by-side

» 2882354

EV LI-ION '18, EV LI ION '16, EV '15-18, ETX '15-16, CREW 570-4 '15-18, 570 '15-18, 500 '17-18



RATCHETING RHINO GRIP® XL BY KOLPIN®

» 2881575

ALL RANGER® MODELS



LOCK & RIDE RHINO GRIP® XL BY KOLPIN®

» 2881574

ALL RANGER® MODELS

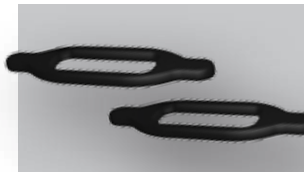

RHINO GRIP® RUBBER STRAPS BY KOLPIN®

» 2881621



POLARIS® GUN BOOT® BY KOLPIN®

- Works with shotgun or rifle
- Padded interior, dustproof, water-resistant

» BLACK • 2872677

» MOSSY OAK® BREAK-UP® • 2872677-419

Fits Polaris® Lock & Ride® Gun Scabbards



POLARIS PURSUIT® CAMO SXS FIELD COVER

» 2882160

EV LI-ION '18, EV LI ION '16, EV '11-18, ETX '15-16, CREW 500-4 '13, 800 '13-14, 570 '14-18, 500 '11-18, 400 '11-14



LOCK & RIDE GUN RACK 6

- Adjustable to store guns at an angle or vertical (shown at angle)
- Holds 6 rifles or shotguns securely with soft rubber V-grips
- Stock is secured in place with a soft molded rubber inlay along the bottom of the rack
- Rack can be adjusted into 3 positions based on the height of your firearms

» 2882159

XP 900 '13-18, XP 570 '15-16, XP 1000 '17-18, XP 1000 HL '18, DIESEL '14-17, CREW XP 900 '14-18, CREW XP 570 '15-16, CREW XP 1000 '17-18, CREW DIESEL '16-17, CREW 570-6 '17

LOCK & RIDE DUAL GUN SCABBARD - HIGH

- Mounted low along the top of the cargo box against the cab
- Securely holds 2 gun boots (sold separately)

» 2877709

EV '11-18, EV LI-ION '18, EV LI ION '16, ETX '15-16, CREW 570-4 '14-18, CREW 500-4 '13, 800 '13-14, 570 '14-18, 500-4 '11, 500 '11-18, 400 '11-14



Never transport a loaded firearm. Verify firearm is unloaded prior to mounting. Please refer to local laws and regulations regarding the requirements for the legal transport of firearms.

67

66



Polaris Northstar® coolers survive just about anything - from extreme heat to a full-on bear attack. Ice will stay cold for hours on end, and anything inside will stay locked up tight.



POLARIS NORTHSTAR® COOLER

99.4 L **NEW** FALL AVAILABILITY

- » GRAPHITE • 2883426
- » DESERT • 2883392

56.8 L

- » **NEW** GRAPHITE • 2883425
- » DESERT • 2881259

28.4 L

- » **NEW** GRAPHITE • 2883424
- » DESERT • 2881315

18.9 L SOFTSIDE **NEW**

- » GRAPHITE • 2883390

TUMBLERS **NEW** [NOT SHOWN]

- » 887 mL • 2883394
- » 591 mL • 2883393



28.4, 56.8, 99.4 LITERS FEATURES



ComfortCarry Handles

Carry a fully loaded cooler with comfort and ease



TravelLock System

Integrated tie-down cleats easily secure to any off-road vehicle, boat, or truck



EasyOut Drain System

Large, easy-to-open plug for rapid draining



NoSlip Rubber Feet

Firm placement on any surface



PolarWall Insulation

Thick 5 cm insulation ensures premium cooling



IceLock Seal

Airtight gasket along the lid keeps cold air in



POLARIS NORTHSTAR® COOLER ACCESSORIES



WIRE BASKET

- » 2882185 • 56.8 LITERS • **SHOWN**
- » 2882438 • 28.4 LITERS



SEAT CUSHION

- » 2882179 • 56.8 LITERS • **SHOWN**
- » 2882507 • 28.4 LITERS



COOLER WHEELS

- » 2882180 • 56.8 LITERS



DIVIDERS

- » 2882184 • 56.8 LITERS • **SHOWN**

COMES WITH TWO DIVIDERS

- » 2882186 • 28.4 LITERS

COMES WITH ONE DIVIDER



Divider doubles as a cutting board

BOTTLE OPENER

- » 2882183

ALL COOLERS



LOCK & RIDE QUICKSTRAP

- » 2882187

ALL COOLERS, POLARIS GENERAL CARGO BOXES



TIE-DOWN STRAPS

- » 2859047-01 • RED
- » 2859047-02 • BLACK

ALL COOLERS

DEPENDABLE. TOUGH. BUILT FOR THE OFF-ROAD.

- ✓ Tested **1,200+** pulls at max load, so it works when you need it to
- ✓ Built to withstand **-29°C** temperatures
- ✓ Sealed motor & heavy duty gears **OPERATE FULLY SUBMERGED UNDERWATER**
- ✓ **MILITARY** tested & approved
- ✓ **FULLY INTEGRATED** mount & wiring



POLARIS NORTHSTAR® COOLERS & WINCHES



PRO PRO HEAVY DUTY SERIES

4,500 LB. (2041 KG) WINCH



WIRELESS REMOTE

Wireless remote control with unique code for interference-free operation

Sealed Permanent Magnet Motor



Cut Steel Gears & Sealed Drivetrain

Premium Synthetic Rope

- Superior Flexibility
- Great Strength
- Lightweight & Easy to Handle

AUTO STOP TECHNOLOGY

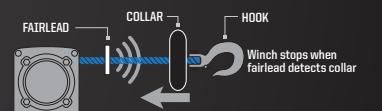

Auto stop technology stops winch at end of pull to prevent driveline stress & plow overlifting

PREASSEMBLED

Winch ready to install out of the box

Hook With Strap





DEPENDABLE. TOUGH. BUILT FOR THE OFF-ROAD.

- ✓ Tested **1,200+** pulls at max load, so it works when you need it to
- ✓ Sealed motor & heavy duty gears **OPERATE FULLY SUBMERGED UNDERWATER**
- ✓ **FULLY INTEGRATED** mount & wiring
- ✓ Built to withstand **-29° C** temperatures

PREMIUM FEATURES FOR TOP-OF-THE-LINE POWER

PRO PRO HEAVY DUTY SERIES

- WIRELESS REMOTE**
- Included with all Pro HD winches
 - Up to 50' range with LED indicator

- ALUMINUM FAIRLEAD**
- Extends rope life, corrosion-resistant
- SYNTHETIC ROPE**
- Superior flexibility, great strength, lightweight

- AUTO-STOP TECHNOLOGY**
- Stops winch at end of pull, prevents driveline stress
 - Great for plowing, prevents overlifting
 - Winch stops when collar on rope contacts fairlead

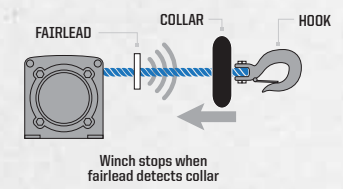

PULLING POWER FOR EVERYDAY USE & PERFORMANCE

I-11D HEAVY DUTY SERIES

- Cut steel gears for improved durability
- Steel spool can handle extreme loads
- 40% quieter – near-silent free spooling

- Sealed motor and drivetrain
- High-powered contactor
- Integrated wiring and mount plates ensure perfect fit

FULL-SIZE

POLARIS® PRO HD 6,000 LB. (2,722 KG) WINCH

- Our most powerful winch ever, perfectly matched to your machine
 - Already wired to easily install winch controls
 - Mounts in designated locations on the vehicle frame
 - 15.2 m synthetic rope
- » **2882716**
XP 1000 '18
AVAILABLE FALL 2017
- » **2881668**
XP 1000 '17, XP 900 '13-18, XP 570 '16, DIESEL '14-18, 570 FULL-SIZE '15, CREW XP 1000 & 900 '13-18, CREW XP 570 '16, CREW DIESEL '14-18, CREW 570 FULL-SIZE '15

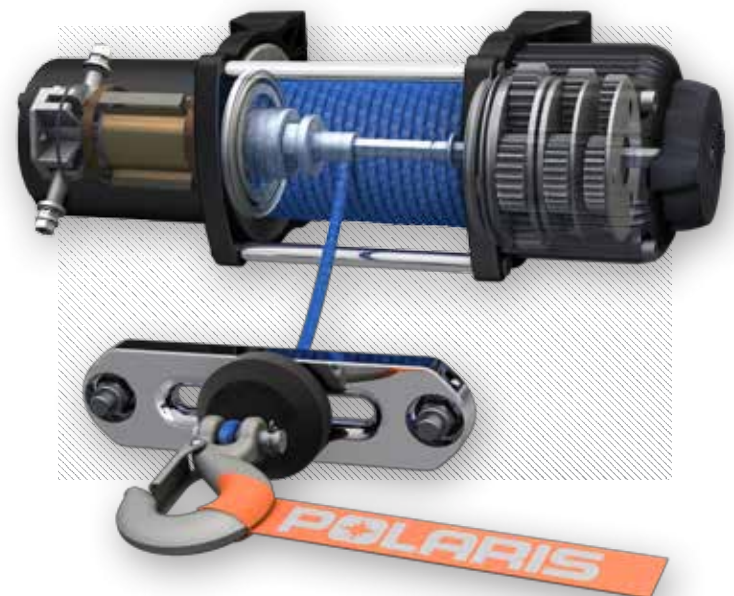

FULL-SIZE MID-SIZE & 570 FULL-SIZE

POLARIS® PRO HD 4,500 LB. (2,041 KG) WINCH

- Low-voltage operation preserves the battery charge life of your RANGER®
 - Already wired to easily install winch controls
 - Mounts in designated locations on the vehicle frame
 - 15.2 m synthetic rope
- » **2882715**
XP 1000 '18
AVAILABLE FALL 2017
- » **2881666**
XP 1000 '17, XP 900 '13-18, XP 570 '16, DIESEL '14-18, 570 FULL-SIZE '15, CREW XP 1000 & 900 '13-18, CREW XP 570 '16, CREW DIESEL '14-18, CREW 570 FULL-SIZE '15

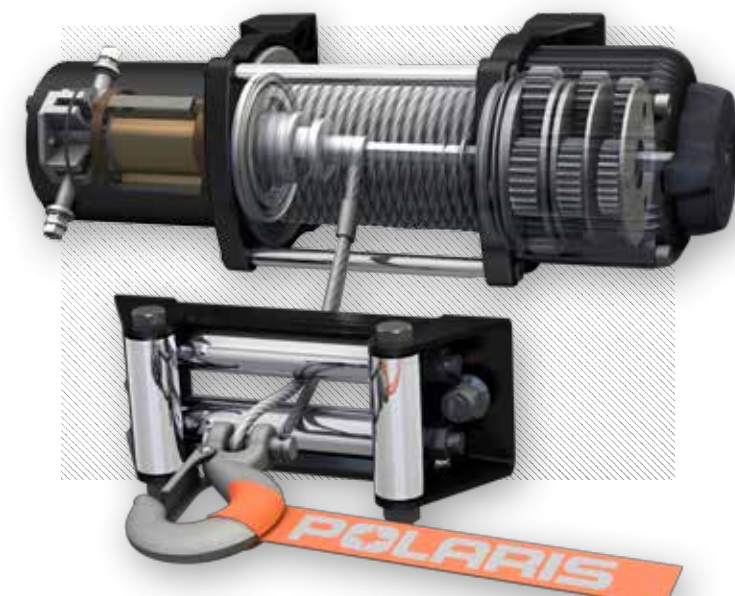

FULL-SIZE

POLARIS® HD 4,500 LB. (2,041 KG) WINCH **TOP SELLER**

- Reliable pulling power with 4,500 lb. (2,041 kg) pull rating
 - Steel cable and steel roller fairlead
 - Wired remote included
 - Already wired to easily install winch controls
- » **2882714**
XP 1000 '18
AVAILABLE FALL 2017
- » **2881667**
XP 1000 '17, XP 900 '13-18, XP 570 '16, DIESEL '14-18, 570 FULL-SIZE '15, CREW XP 1000 & 900 '13-18, CREW XP 570 '16, CREW DIESEL '14-18, CREW 570 FULL-SIZE '15

MID-SIZE & 570 FULL-SIZE

POLARIS® HD 3,500 LB. (1,588 KG) WINCH **TOP SELLER**

- 3,500 lbs. (1,588 kg) pulling capacity
 - Fully sealed contactor, motor, and drive gears
 - 15.2 m of 5.5 mm high-strength steel cable
 - Durable corrosion-resistant finish
- » **2881669**
570 FULL-SIZE '16-18, CREW 570 FULL-SIZE '16-18, 570/500/ETX '15-18, LI-ION EV & EV '15-18, CREW 570 '15-18

UPGRADE YOUR POLARIS® HD WINCH WITH THESE ACCESSORIES

POLARIS® WIRELESS WINCH REMOTE

- Allows for remote operation of Polaris® HD winch
- Up to 50' range with LED indicator
- Direct plug and play operation

» **2879316**
Works with 2882714, 2881667, 2881669

POWER CONTROLLER

- Control your winch and plow hydraulics directly from the shift knob
- Ideal for plowing; lift and angle directly at your fingertips

» **2883247**
XP 1000 '18 **NEW**
AVAILABLE FALL 2017

» **2879227**
XP 1000 '17, XP 900 '13-18, XP 570 '16, DIESEL '14-18, 570 FULL-SIZE '15, CREW XP 1000 & 900 '13-18, CREW XP 570 '16, CREW DIESEL '14-18, CREW 570 FULL-SIZE '15

AUTO-STOP WINCH UPGRADE KIT

» **2881692**
Works with 2881667 & 2881669

SYNTHETIC WINCH ROPE

6000 WINCH SERIES
» **2879187**

4500 WINCH SERIES
» **2879188**

3500 WINCH SERIES
» **2878888** **NEW**

WINCH WIRING KIT

» **2881684**

POLARIS® PRO HD WINCH UPGRADE

- Works with auto-stop technology at end of pull or plow lift
 - Machined from billet aluminum and weighs less than common steel fairleads
 - Installs easily in place of stock fairlead
 - Not included but requires winch rope (not compatible with steel cable)
- » **2881693**
XP 900 '13-18, XP 570 '15-16, XP 1000 HL '18, XP 1000 '17, EV LI-ION '18, EV LI-ION '16, EV '11-18, ETX '15-16, DIESEL '11-16, CREW XP 900 '14-18, CREW XP 570 '15-16, CREW XP 1000 '17-18, CREW DIESEL '13-16, CREW 570-4 '14-18, CREW 500-4 '13, 800 '11-14, 6X6 '11-16, 570 FULL SIZE '17-18, 570 '14-18, 500-4 '11, 500 '11-18, 400 '11-14

REQUIRED FOR POLARIS® PRO HD & POLARIS® HD WINCH INSTALLATION

* NOT REQUIRED FOR 2018 XP 1000 WINCHES

BATTERY CONNECTION CABLES

- Necessary component to connect your accessory busbar to the vehicle battery
 - Wires are cut to the precise length of your vehicle to minimize slack
- » **FULL-SIZE • 2879388**
XP 900 '13-18, XP 570 '15-16, XP 1000 HL '18, XP 1000 '17, DIESEL '14-17, CREW XP 1000 '17
- » **MID-SIZE • 2879990**
ETX '15-16, 570 '15-18, 500 '17-18
- » **MID-SIZE CREW • 2880929**
ETX '15-16, CREW 570-4 '15-18, 570 '15-18, 500 '17-18
- » **FULL-SIZE CREW • 2879685**
CREW XP 900 '14-18, CREW XP 570 '15-16, CREW XP 1000 '17-18, CREW DIESEL '16-17

GLACIER[®]

PLOW SYSTEM

EASILY CONQUER WINTER'S WORST

Install a Polaris Glacier[®] plow system and move some serious snow when winter's wrath comes calling. Only with a Glacier[®] plow do you get drive up and plow capability with simple Lock & Ride[®] installation and removal. Choose from the unbeatable capability of the top-of-the-line Glacier[®] Pro HD, or get amazing performance and value with the Glacier[®] HD.

THE POLARIS ENGINEERED[™] ADVANTAGE

INSTALLATION

With the integrated Lock & Ride[®] attachment points, you can easily drive up to the plow frame, attach and be plowing in moments.



ROBUST PLOW FRAME

Constructed of heavy-duty steel with e-coated rust protection, giving you a durable system you can rely on season after season.



SHEAR PIN PROTECTION

Engineered to protect your vehicle, shear pins act as a fail-safe point in the instance of accidental collision or over-exertion of the plow system.

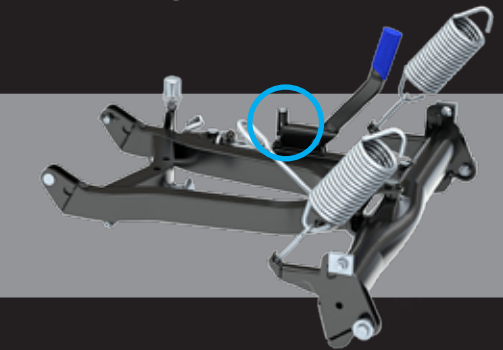

BLADE MATERIAL

Durable poly and steel blades are designed to push more. Choose a steel blade for longevity and increased rigidity or a lightweight non-stick, poly blade that's easier on plowing surfaces.

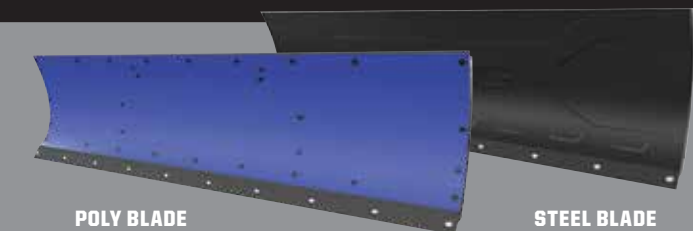

POLY BLADE

STEEL BLADE

CONVENIENT CONTROL

Lift and angle your blade right from the driver's seat with the addition of hydraulics on the Glacier[®] Pro HD Plow System.



ANGLE YOUR BLADE
RIGHT FROM YOUR SEAT
WITH THE GLACIER[®] PRO
PLOW HYDRAULIC
ANGLE SYSTEM

GLACIER[®] PRO HD

PLOW SYSTEM

HYDRAULIC CONTROL FOR EXTREME

SNOW REMOVAL

A robust frame and tough blades, combined with a convenient hydraulic angle system, allow your Glacier[®] Pro HD to move serious snow while you remain comfortable. Thanks to Lock & Ride[®] technology, the Pro HD comes standard with a convenient kickstand attachment to the plow frame, giving you the easiest attachment.

LOCK & RIDE

DRIVE-UP. LINK UP.

The auto-retracting frame kickstand allows for convenient drive-in plow frame hook-up.

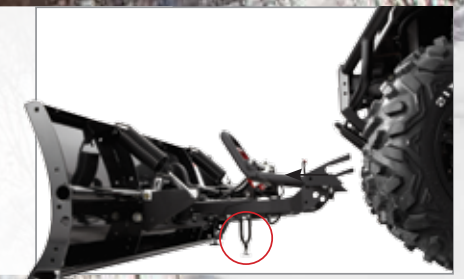

OPTIONAL HYDRAULIC CONTROL

Control the blade without leaving the comfort of your cab by adding hydraulic lift and angle systems exclusive to Glacier[®] Pro HD.

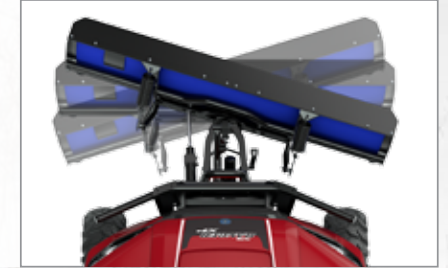

FULL-SIZE

XP 1000 '18, XP 1000 '17, XP 900 '13-18, XP 570 '16, DIESEL '14-18, 570 FULL-SIZE '15, CREW XP 1000 & 900 '13-18, CREW XP 570 '16, CREW DIESEL '14-18, CREW 570 FULL-SIZE '15

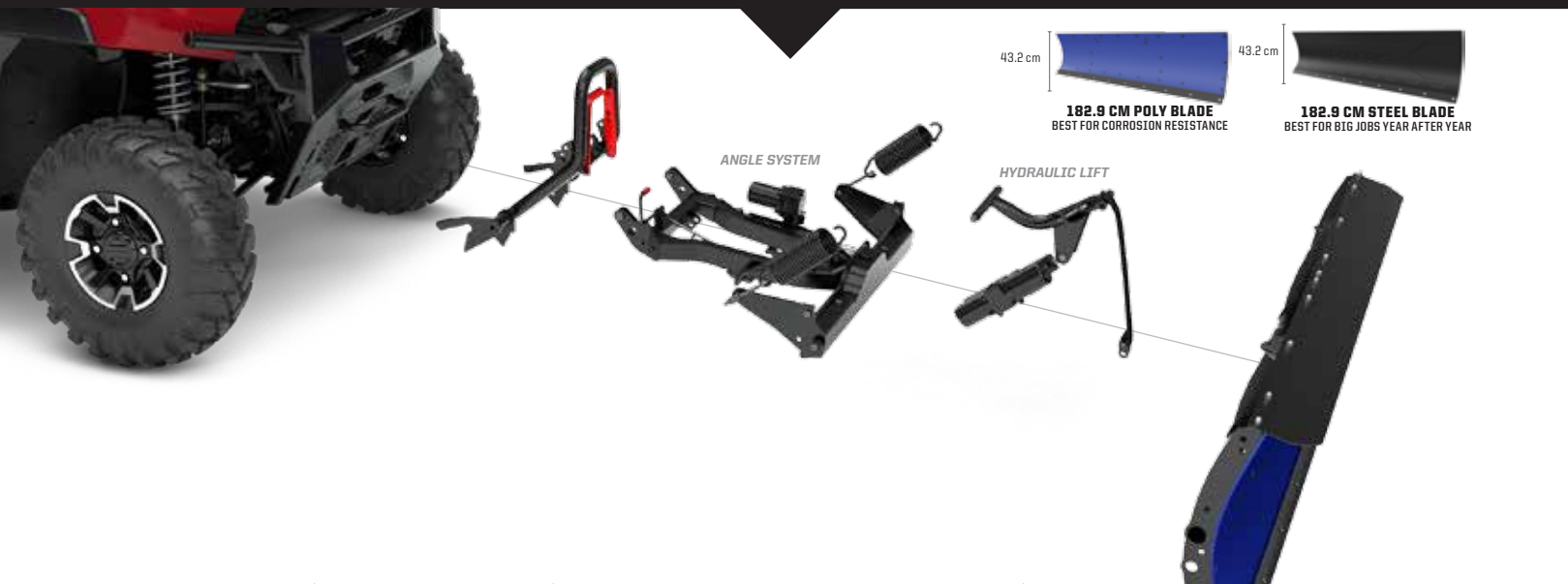

MID-SIZE + 570 FULL-SIZE

570 FULL-SIZE '16-18, 570/500/ETX '10-18, LHON EV & EV '15-18, CREW 570 '10-18, CREW 570 FULL-SIZE '16-18

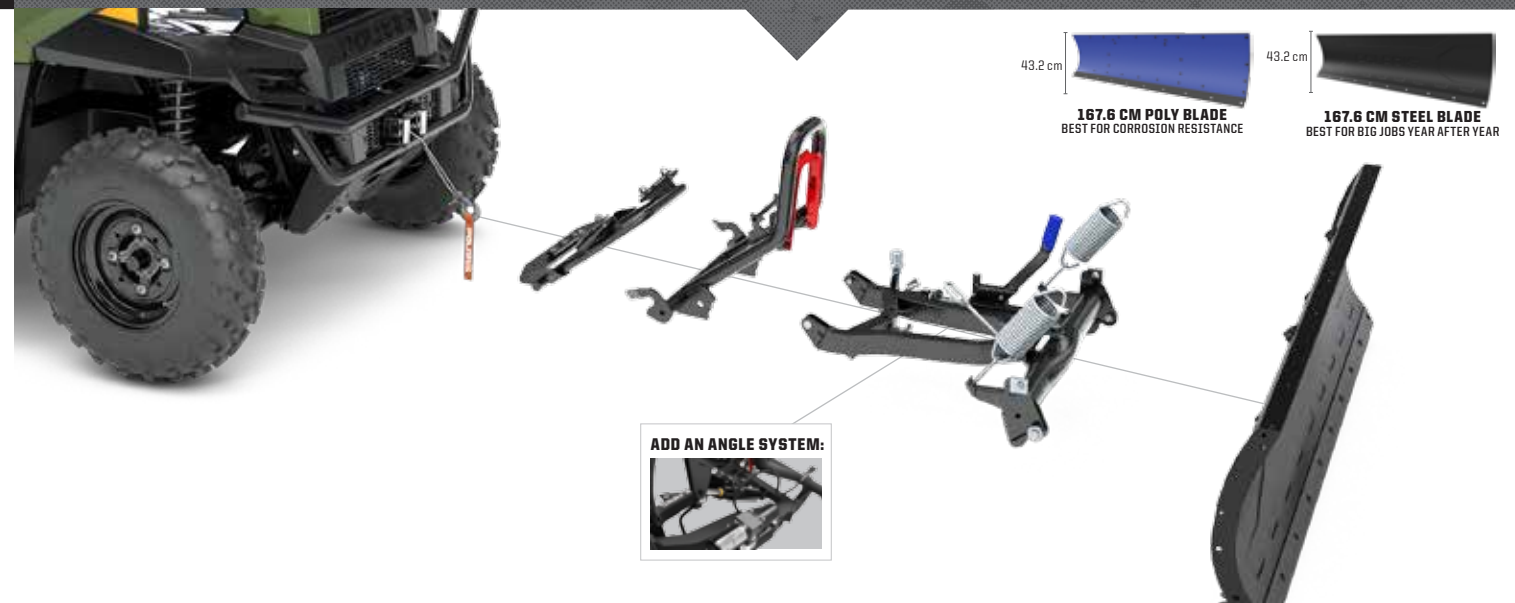

ADD AN ANGLE SYSTEM:



STEP 1 SELECT A MOUNT	STEP 2 SELECT A FRAME	STEP 3 CONFIGURE PLOW	STEP 4 SELECT A BLADE	STEP 5 SELECT ACCESSORIES	STEP 1 SELECT A MOUNT	STEP 2 SELECT A FRAME	STEP 3 CONFIGURE PLOW	STEP 4 SELECT A BLADE	STEP 5 SELECT ACCESSORIES	
GLACIER[®] PRO HD PLOW MOUNT NOT REQUIRED FOR XP 1000 '18 2879106	GLACIER[®] PRO HD PLOW PUSH FRAME » 2883255 ALL FULL-SIZE RANGER [®] REPLACEMENT SHEAR PIN » 2204829 PLOWING WITH TRACKS? GLACIER[®] PRO HD TRACK EXTENSION » 2879871	SELECT A LIFT METHOD GLACIER[®] PRO HD PLOW HYDRAULIC LIFT SYSTEM » 2883410 XP 1000 '18 » 2879220 ALL OTHER FULL-SIZE POLARIS[®] PRO HD 6000 LB. WINCH POLARIS[®] PRO HD 4500 LB. WINCH SEE WINCHES FOR FITMENT P. 70-71	ADD AN ANGLE SYSTEM GLACIER[®] PRO HD PLOW HYDRAULIC ANGLE SYSTEM » 2883409 XP 1000 '18 » 2879224 ALL OTHER FULL-SIZE	GLACIER[®] PRO HD PLOW BLADE - 182.9 CM POLY » 2879317 GLACIER[®] PRO HD PLOW BLADE - 182.9 CM STEEL » 2879874 POWER CONTROLLER » 2879227 ALL OTHER FULL-SIZE » 2883247 XP 1000 '18 AVAILABLE FALL 2017 Lift and change the angle of the plow blade with the Power Controller Required with Glacier [®] Hydraulic Systems	MID-SIZE GLACIER[®] PRO HD PLOW MOUNT » 2880261	MID-SIZE GLACIER[®] PRO HD PUSH FRAME » 2880260 REPLACEMENT SHEAR PIN » 2205527	SELECT A LIFT METHOD POLARIS[®] PRO HD 4500 LB. WINCH 2871806 POLARIS[®] HD 3500 LB. WINCH SEE WINCHES FOR FITMENT P. 70-71	ADD AN ANGLE SYSTEM GLACIER[®] PRO HD PLOW HYDRAULIC ANGLE SYSTEM » 2880266 Requires Power Controller	182.9 CM STEEL BLADE » 2880270 GLACIER[®] PRO HD PLOW 167.6 CM POLY BLADE » 2880269 GLACIER[®] PRO HD PLOW 167.6 CM STEEL BLADE » 2880268	 POWER CONTROLLER » 2879227 Change the angle of the plow blade with the Power Controller

SELECT ACCESSORIES

PLOW BLADE SNOW DEFLECTOR

- » 167.6 cm • 2879866
- » 152.4 cm • 2871808

QUICK RELEASE SKID SHOES

- Helps prevent blade wear
- Hardened steel for industrial strength
- » 2877245

COIL SPRING SPACER

- Keep the front end of the vehicle up and improve ride quality when using a plow on strut or A-arm vehicles
- » 2872655

WEAR BARS

- Protect your plow blade and minimize wear on the actual blade by installing Wear Bars
- » 182.9 cm • 2879864
- » 167.6 cm • 2879867
- » 152.4 cm • 2871806
- » HD 182.9 cm • 2879875
- » HD 167.6 cm • 2879868
- » 132.1 cm • 2877210

PLOW MARKER

- Helps driver monitor plow blade position
- Sold in pairs
- » 2872726

PLOW LINK

- » 2204974

GLACIER[®] HD

PLOW SYSTEM

MAKE QUICK WORK OF THE SMALLER JOBS

Move some snow with the robust and capable Glacier[®] HD plow system, and discover why a major snowfall can be a the highlight of your week. With a robust frame, beefy poly and steel blade options, convenient Lock & Ride[®] mounting and dismounting and amazing value, Glacier[®] HD is a great choice in the dead of winter.



FULL-SIZE

XP 1000 '18, XP 1000 '17, XP 900 '13-18, XP 570 '16, DIESEL '14-18, 570 FULL-SIZE '15, CREW XP 1000 & 900 '13-18, CREW XP 570 '16, CREW DIESEL '14-18, CREW 570 FULL-SIZE '15

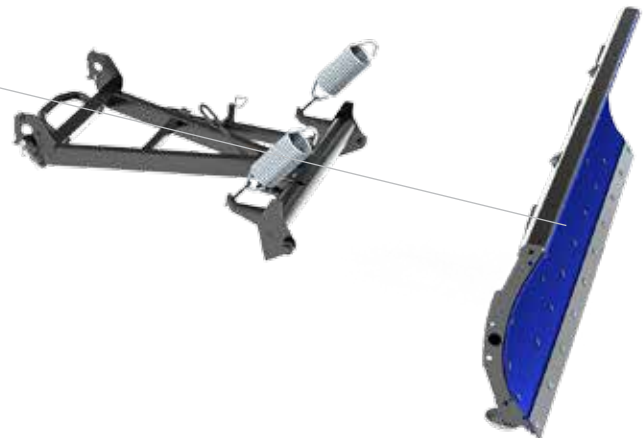

MID-SIZE + 570 FULL-SIZE

570 FULL-SIZE '16-18, 570/500/ETX '10-18, LH-ION EV & EV '15-18, CREW 570 '10-18, CREW 570 FULL-SIZE '16-18

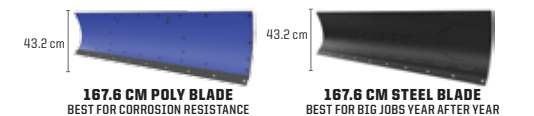

STEP 1 SELECT A MOUNT	STEP 2 SELECT A FRAME	STEP 3 SELECT LIFT METHOD	STEP 4 SELECT A BLADE	STEP 1 SELECT A MOUNT	STEP 2 SELECT A FRAME	STEP 3 SELECT A LIFT METHOD	STEP 4 SELECT A BLADE
GLACIER[®] HD PLOW MOUNT NOT REQUIRED FOR XP 1000 '18 » 2879106	GLACIER[®] HD PLOW FRAME NEW » 2882927 REPLACEMENT SHEAR PIN » 2204829	POLARIS[®] HD 4500 LB. WINCH SEE WINCHES FOR FITMENT P. 70-71	GLACIER[®] HD PLOW BLADE - 182.9 CM STEEL NEW » 2880270 GLACIER[®] HD PLOW BLADE - 167.6 CM POLY » 2880269 GLACIER[®] HD PLOW BLADE - 167.6 CM STEEL » 2880268	GLACIER[®] HD PLOW MOUNT » 2879105	GLACIER[®] HD PLOW FRAME » 2882927 REPLACEMENT SHEAR PIN » 2205527	POLARIS[®] HD 3500 LB. WINCH SEE WINCHES FOR FITMENT P. 70-71	GLACIER[®] HD PLOW BLADE - 167.6 CM POLY Strong, durable and corrosion-resistant blade is best for impact absorption needed for serious snow removal » 2880269 GLACIER[®] HD PLOW BLADE - 167.6 CM STEEL » 2880268

SELECT ACCESSORIES

PLOW BLADE SNOW DEFLECTOR

- » 167.6 cm • 2879866
- » 152.4 cm • 2871808

QUICK RELEASE SKID SHOES

- Helps prevent blade wear
- Hardened steel for industrial strength
- » 2877245

COIL SPRING SPACER

- Keep the front end of the vehicle up and improve ride quality when using a plow on strut or A-arm vehicles
- » 2872655

WEAR BARS

- Protect your plow blade and minimize wear on the actual blade by installing Wear Bars
- » 182.9 cm • 2879864
- » 167.6 cm • 2879867
- » 152.4 cm • 2871806
- » HD 182.9 cm • 2879875
- » HD 167.6 cm • 2879868
- » 132.1 cm • 2877210

PLOW MARKER

- Helps driver monitor plow blade position
- Sold in pairs
- » 2872726

PLOW LINK

- » 2204974



Polaris® and Pro Armor® developed a deep partnership thanks to having similar histories and a passion for producing products that enhance vehicle performance. Each wheel and tire Pro Armor® designs and engineers for Polaris® off-road vehicles performs perfectly in the intended environment for its intended use. Developed, tested and produced in partnership so you can tackle the terrain ahead.



TRIPLE-BELTED SIDEWALLS

Sidewalls can be a vulnerable area of any off-road tire. Rocks jump out at your machine and tear into sidewalls. Thanks to reinforced construction in this critical area, Pro Armor® resists when others fail.

10-PLY

Pro Armor® builds the toughest tires to keep you running when the terrain turns tough. A higher ply rating means added protection. Choose your tire and ply rating based on use and overall performance needs.

DUAL COMPOUNDS

You don't ride or drive in just one type of terrain, so Pro Armor® builds certain tires with multiple wear zones. A dual-durometer design allows the tire to wear better with softer outer lugs and harder inner lugs.

4,828 KILOMETER RATED

Pile on the miles with Pro Armor® tires. Every tire is designed and constructed with longevity in mind. With ratings of 4,828 kilometers and beyond, you are assured long life and performance.

TIRE: **DUAL-THREAT** WHEEL: **BUCKLE ACCENT**

KNOW YOUR TIRES

DIMENSIONS	TREAD DEPTH	WEIGHT	PLY RATING	SIDEWALL BELTS	LOAD RATING	PADDLE DEPTH
28" x 9" R14	A deeper tread means more grip and cleaner performance	A lighter tire makes for improved vehicle performance	Indicates the overall load capability of the tire	Sidewall belts increase your resistance to sidewall punctures	Tires with higher load ratings can handle more weight	Increases grip and performance in the sand
TIRE HEIGHT TIRE WIDTH WHEEL DIAMETER						



PRO ARMOR® DUAL-THREAT **NEW**

- Dual-compound technology and radial construction offer performance in all terrains
- Softer durometer rubber on outer edge for overall superior grip and feel
- Harder durometer rubber in the middle for increased traction during acceleration and longer tread life

- 14" **26" x 9" R14** - FRONT 5416340
- 14" **26" x 11" R14** - REAR 5416341
- 14" **29" x 9" R14** - FRONT 5416342
- 14" **29" x 11" R14** - REAR 5416343

		TREAD DEPTH	TIRE WEIGHT	PLY RATING	SIDEWALL BELTS	LOAD RATING
26R14	FRONT	16mm	12.2 kg	10	3	413 kg
	REAR		13.6 kg			503 kg
29R14	FRONT	16mm	13.6 kg	10	3	503 kg
	REAR		15.9 kg			599 kg

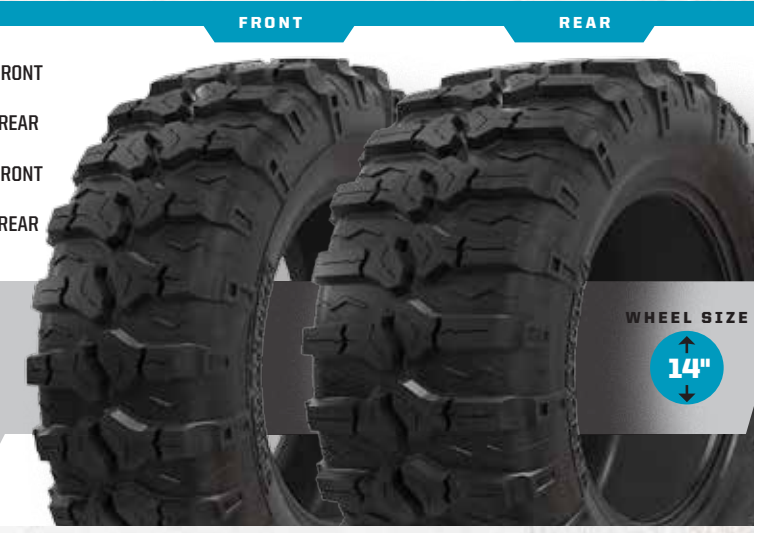

PRO ARMOR® ATTACK 2.0 **NEW**

- Engineered for excellent hard-pack performance
- Dual-compound technology and radial construction offer performance in all terrains.
- Tight tread pattern for quieter ride

15" **28" x 10" R15** - FRONT/REAR - 5416344

	TREAD DEPTH	TIRE WEIGHT	PLY RATING	SIDEWALL BELTS	LOAD RATING
FRONT	25mm	14.5 kg	10	3	503 kg
REAR					



ATTACK 2.0 VS. ATTACK

- **Tighter Tread Pattern** = Better traction in hard pack
- **Dual-Durometer Lug** = Increased grip & traction in rough terrain, smoother ride in all terrain
- **10-Ply Rated** = Increased durability
- **Larger size offering in 28"** = More ground clearance & trail traction



PRO ARMOR® ATTACK

- The best all-purpose tire for all-season traction in any terrain
- Unique, full-face tread design
- Harder durometer lugs promote extended wear, increasing tire life
- Wider spaced lugs provide more grip in softer terrain

14" **26" x 9" R14** - FRONT - 5415613
 14" **26" x 11" R14** - REAR - 5415614

	TREAD DEPTH	TIRE WEIGHT	PLY RATING	SIDEWALL BELTS	LOAD RATING
FRONT	23mm	12.7 kg	8	3	413 kg
REAR					599 kg



UTILITY



PRO ARMOR® HARVESTER™

- All-around work horse with tread life of 5,000 miles
- Tread pattern designed to withstand anything from the farmyard to the pastures and the trail
- With 10-ply, it can carry the load day in and day out

- 14" 27" x 10" R14 FRONT • 5415965
- 12" 26" x 8" R12 • FRONT 5416396
- 14" 28" x 10" R14 • REAR 5416347
- 12" 26" x 10" R12 • REAR 5415966

	TREAD DEPTH	WEIGHT	PLY RATING	SIDEWALL BELTS	LOAD RATING
26R12	FRONT	10.9 kg	10	3	388 kg
	REAR	14.5 kg			599 kg
27R14	FRONT	14.5 kg			599 kg
28R10	REAR	15.4 kg			599 kg



WHEEL SIZE
14" 12"

ROCK



PRO ARMOR® CRAWLER XR

- Wanna race? This tire grips it all, from the trail to the rocks
- Square block profile for even surface contact
- A tougher durometer than the XG to take on the toughest the trail has to offer

- 14" 28" x 10" R14 • FRONT/REAR • 5415536

TREAD DEPTH	WEIGHT	PLY RATING	SIDEWALL BELTS	LOAD RATING
16mm	14.5 kg	8	3	517 kg



WHEEL SIZE
14"

SINGLE-DUROMETER

Smaller lug height and single-durometer gives this high-speed tire added construction and lateral stability when cornering. Its unique lug design excels in hard-packed, fast terrain.



PRO ARMOR® PRESERVE™ **NEW**

- Turf-friendly for areas where low-impact from tire tread is needed
- Rounded profile and special tread pattern to limit footprint

- 14" 27" x 10" R14 • FRONT/REAR 5416348
- 12" 28" x 10" R12 • REAR 5416402
- 12" 26" x 8" R12 • FRONT 5416403

	TREAD DEPTH	WEIGHT	PLY RATING	SIDEWALL BELTS	LOAD RATING
27R14		10.9 kg	10	3	388 kg
28R14	16mm	11.8 kg			599 kg
28R12		12.7 kg			630 kg



WHEEL SIZE
14" 12"



PRO ARMOR® CRAWLER XG

- Big or small, these tires crawl them all
- A soft, sticky compound makes this tire ideal for both rock crawling and desert running
- 8-ply, triple-belted ballistic sidewalls resist punctures

- 15" 28" x 10" R15 • FRONT/REAR • 5416346

TREAD DEPTH	WEIGHT	PLY RATING	SIDEWALL BELTS	LOAD RATING
20mm	14.5 kg	8	3	503 kg



WHEEL SIZE
15"

DUAL-DUROMETER

With its taller lug height and dual-durometer construction, this tire has the perfect balance between high-speed performance, durability and flex in order to grip slick rock.



PRO ARMOR® XD-K

- 26" Aramid fiber-belted tire to tackle any terrain
- Unique full-face tread design
- Harder durometer lugs promotes extended wear, increasing tire life

- 12" 26" x 11" R12 • REAR 5415757
- 12" 26" x 9" R12 • FRONT 5415756

	TREAD DEPTH	WEIGHT	PLY RATING	SIDEWALL BELTS	LOAD RATING
FRONT	31.7mm	12.7 kg	8	3/1 KEVLAR®	424 kg
REAR		14.5 kg			499 kg



WHEEL SIZE
12"

MUD



PRO ARMOR® DAGGER

- From the trails to the pits, this tire gets you through it all
- Deep, self-cleaning lugs and wide tire design for exceptional mud pit performance
- Rounded profile and full lug pattern for on-trail comfort

- 14" 27" x 9" R14 • FRONT 5415617
- 14" 27" x 11" R14 • REAR 5415618

	TREAD DEPTH	WEIGHT	PLY RATING	SIDEWALL BELTS	LOAD RATING
FRONT	38mm	14.5 kg	8	3	499 kg
REAR		18.1 kg			531 kg



WHEEL SIZE
14"

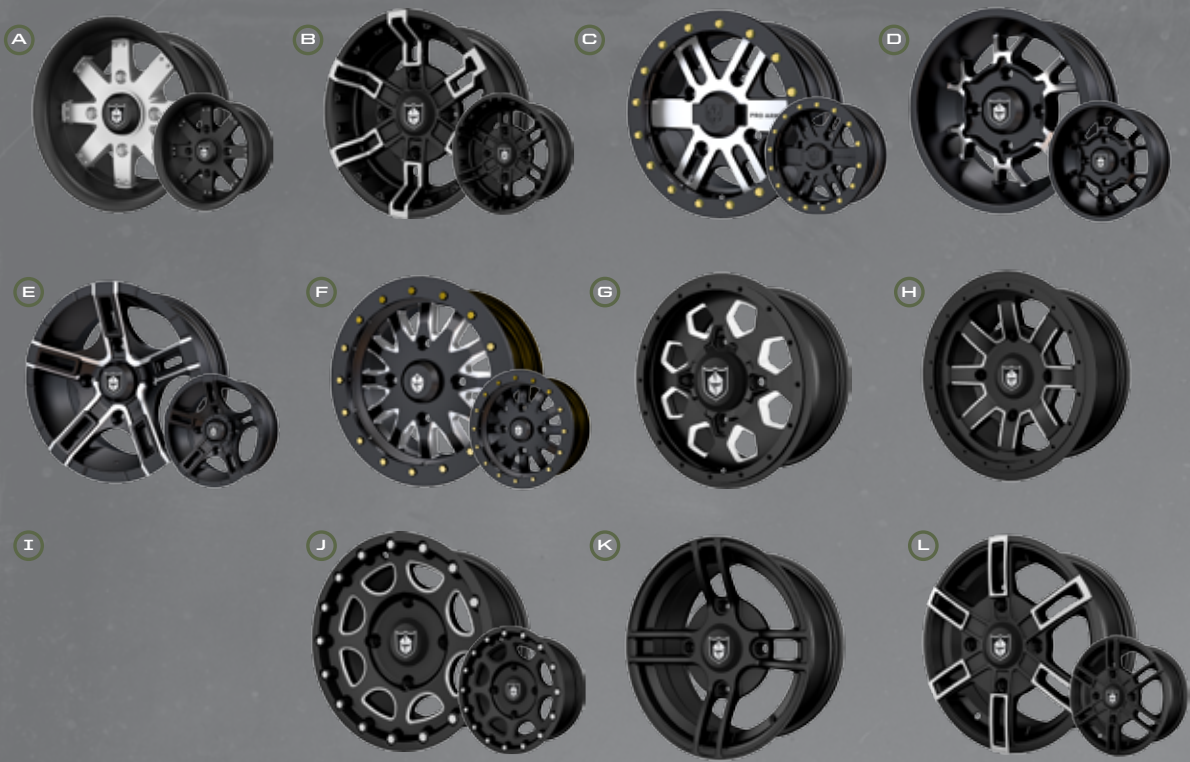

A AMPLIFY

ACCENT: FRONT 14" x 7" • 1522956-266
REAR 14" x 8" • 1522957-266
MATTE BLACK: FRONT 14" x 7" • 1522956-458
REAR 14" x 8" • 1522957-458

B BUCKLE

ACCENT: FRONT 14" x 7" • 1522544-266
REAR 14" x 8" • 1522545-266
MATTE BLACK: FRONT 14" x 7" • 1522544-458
REAR 14" x 8" • 1522545-458

C COMBAT NEW
(BEADLOCK RINGS INCLUDED)

ACCENT: 14" x 7" • 1523284
MATTE BLACK: 14" x 7" • 1523283

D CYCLONE NEW

ACCENT: 15" x 7" • 1523184-266
MATTE BLACK: 15" x 7" • 1523184-458

LUGS

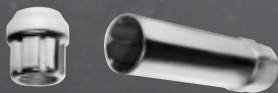

12MM x 1.5 SPLINED LUG NUTS

» 2879332 • 16 SPLINED LUG NUTS WITH WRENCH

» 2879331 • 4 SPLINED LUG NUTS WITHOUT WRENCH

» 2204966 • SPLINED LUG WRENCH

REPLACEMENT CAPS



POLARIS® CAPS

» 1521509-410 • LUSTER

» 1521509-521 • MATTE BLACK
AMPLIFY, BUCKLE, COMBAT, CYCLONE, FLARE, HALO, REBLR, SHACKLE, SIXR, SPLIT, WHITEOUT

» 1522243-410 • LUSTER

» 1522243-458 • MATTE BLACK
HEXLR

J SHACKLE

ACCENT: FRONT 14" x 7" • 1522546-266
REAR 14" x 8" • 1522547-266
MATTE BLACK: FRONT 14" x 7" • 1522546-458
REAR 14" x 8" • 1522547-458

K SPLIT

MATTE BLACK: FRONT 14" x 6" • 1522542-458
REAR 14" x 8" • 1522543-458

L WYDE

ACCENT: 15" x 7" • 1522550-266
MATTE BLACK: 15" x 7" • 1522550-458

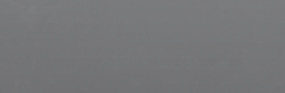

PRO ARMOR® CAPS

» 5453209-410 • LUSTER

» 5453209-458 • MATTE BLACK
AMPLIFY, BUCKLE, COMBAT, CYCLONE, FLARE, HALO, REBLR, SHACKLE, SIXR, SPLIT, WHITEOUT

» 1523015-410 • LUSTER

» 1523015-458 • MATTE BLACK
HEXLR

» 1523063-458 • MATTE BLACK
WYDE



14" FORGED BEADLOCK RINGS

- Only used on REBLR wheels
- BEADLOCK rings sold individually

» VOOODOO BLUE
1522244-619

» MACHINED
1522244-266

» WHITE
1522244-133

» INDY RED
1522244-293

» ORANGE CRUSH
1522244-589

15" FORGED BEADLOCK RINGS

NOT SHOWN

- Only used on HEXLR wheels
- Beadlock rings sold individually

» BRIGHT WHITE
1522240-133

» MACHINED
1522240-266

» INDY RED
1522240-293

» ORANGE CRUSH
1522240-589

» VOOODOO BLUE
1522240-619

REPLACEMENT FORGED BEADLOCK RINGS - BLACK

- Only used on COMBAT and HALO wheels

» 14" • 1523146-458

» 15" • 1523147-458

TIRE SEALANT

» 946 ML
2830484

» 3.8 L
2830485

» 18.9 L
2830486

» 18.9 L PUMP
2830487

14" SETS

TIRES >	ATTACK <small>*ALL RANGER</small>	DAGGER <small>*ALL RANGER</small>	DUAL-THREAT 26" <small>*ALL RANGER</small>	DUAL-THREAT 29" <small>*MY18 XP 1000 ONLY</small>	PRESERVE 27" <small>*RANGER XP</small>	HARVESTER 27" <small>*RANGER XP</small>	HARVESTER 28" <small>*MY18 XP 1000 ONLY</small>	CRAWLER XR 28" <small>*MY18 XP 1000 ONLY</small>
AMPLIFY <i>Accent</i>	2882390	2882392	2883138	2883146	2883208	2882388	2883225	2882394
AMPLIFY <i>Matte Black</i>	2882391	2882393	2883139	2883147	2883209	2882389	2883226	2882395
BUCKLE <i>Accent</i>	2881335	2881337	2883140	2883148	2883203	2882383	2883220	2881343
BUCKLE <i>Matte Black</i>	2881336	2881338	2883141	2883149	2883204	2882384	2883221	2881344
COMBAT <i>Accent</i> <small>*BEADLOCKS PRE-MOUNTED</small>			2883217	2883219				2883213
COMBAT <i>Matte Black</i> <small>*BEADLOCKS PRE-MOUNTED</small>			2883216	2883218				2883212
REBLR <i>Matte Black</i> <small>*BEADLOCKS SOLD SEPARATELY</small>	2881381	2881383						2881386
SHACKLE <i>Accent</i>	2881347	2881349	2883142	2883150	2883205	2882385	2883222	2881355
SHACKLE <i>Matte Black</i>	2881348	2881350	2883143	2883151	2883206	2882386	2883223	2881356
SIXR <i>Luster</i>	2881359	2881362						2881371
SIXR <i>Matte Black</i>	2881360	2881363	2883144	2883152	2883207	2882387	2883224	2881372
SPLIT <i>Matte Black</i>	2881404	2881405	2883145	2883153				
THRASHER <i>Matte Black</i>	2881378	2881380						

15" SETS

TIRES >	ATTACK 2.0 28" <small>*MY18 XP 1000 ONLY</small>	CRAWLER XG 28" <small>*MY18 XP 1000 ONLY</small>
CYCLONE <i>Accent</i>	2883160	2883188
CYCLONE <i>Matte Black</i>	2883159	2883187
FLARE <i>Accent</i>	2883158	2883186
FLARE <i>Matte Black</i>	2883157	2883185
HALO <i>Accent</i> <small>*BEADLOCKS PRE-MOUNTED</small>	2883162	2883190
HALO <i>Matte Black</i> <small>*BEADLOCKS PRE-MOUNTED</small>	2883161	2883189
HEXLR <i>Matte Black</i> <small>*BEADLOCKS SOLD SEPARATELY</small>	2883154	2883182
WYDE <i>Accent</i>	2883156	2883184
WYDE <i>Matte Black</i>	2883155	2883183

TRACKS



PROSPECTOR PRO® TRACK SYSTEM

- Polaris® exclusive optimized hub geometry that minimizes feedback and eases steering effort
- Flexible lug design for the highest level of deep snow performance by lifting up in deep snow as opposed to digging down
- Lightweight design with slight weight reduction over Camoplast® kit provides for better flotation, eases steering effort and provides better vehicle control

PROSPECTOR PRO® TRACK MOUNTS

- Install this track system mounting hardware in place of tires and wheels. Tracks sold separately
- » 2879621
XP 900 '13-18, XP 570 '15-16, XP 1000 '17, DIESEL '14-18, CREW XP 900 '14-18, CREW XP 570 '15-16, CREW XP 1000 '17-18, CREW DIESEL '16-18
- » 2880071
ETX '15-16, 570 '14-18, 500 '17-18, CREW 570 '15-18
- » 2882783 NEW
XP 1000 '18

PROSPECTOR PRO® TRACK

- » 2880757
XP 1000 (NON-EPS) '16-17, XP 900 (NON-EPS) '16-18, CREW XP 1000 (NON-EPS) '16-18, CREW XP 900 (NON-EPS) '16-18, XP 900 '13-15, CREW 900 '14-15, XP 570 '15-16, 570 '14-16, 570 (NON-EPS) '17-18, DIESEL (NON-EPS) '14-18, CREW DIESEL (NON-EPS) '16-18
- » 2880758
XP 1000 (EPS) '16-17, XP 900 (EPS) '16-18, CREW XP 1000 (EPS) '16-18, CREW XP 900 (EPS) '16-18, 570 (EPS) '17-18, DIESEL (EPS) '14-18, CREW DIESEL (EPS) '16-18
- » 2883313
XP 1000 '18
If using Glacier® Pro Plow System with tracks, Track Flow Extension is required (2889267)

For year around use, Polaris recommends the use of Intake Update Kit (2880673) on any Ranger XP 900 '13-18, RANGER XP 1000 '17, RANGER XP 900/1000 CREW '14-18 with tracks installed. To keep intake system working optimally, this kit pre-filters our fine snow and dust.

INTRODUCING

RIGID®

PRO ARMOR®



LIGHTING

ADVANCED TECH

RIGID® lights are driven by Aluminum PCB Smart Boards™ with copper thermal conductive pads, gold-plated electrical contacts, 6063-T5 aircraft aluminum extruded housings treated with Alodine® corrosion preventive and Tiger Drylac® UV protection polyester powdercoating.

EXCLUSIVE OPTICS

RIGID® hand-selects the brightest high-tech LEDs from the best manufacturers. The LEDs shine through patented optics that maximize total light output and efficiency. RIGID® lights feature impact-resistant polycarbonate lenses for a 100% water/dustproof seal.

RIGID® LIMITED LIFETIME WARRANTY*

If you own a RIGID® light and it breaks, we will replace or repair it for life.*

RIGID® LIGHTS ARE POLARIS PULSE™ READY

PRO ARMOR® LIGHTS ARE POLARIS PULSE™ READY

ADAPT LED LIGHT BARS

FALL AVAILABILITY

NEW

Adjust the lighting pattern for your needs via the in-dash controller. As your speed changes, you can dial in the light from spot to flood.

MATCH YOUR STYLE

Choose from any color in the spectrum to reflect your style or current mood.

CONTROL FROM THE DASH

A backlit, molded dash controller allows you to control the beam pattern and color.

SR-SERIES PRO LED LIGHT BARS **NEW**

These single-row LED light bars provide a sleek, powerful, low-profile lighting solution that measures less than 5 cm tall. The SR-Series is designed to project light at extreme distances while consuming very little power. Rugged, durable and ready for anything.

D-SERIES PRO **NEW**

These lights produce extremely high output while consuming very little power. The compact size and shape allow the D-Series LED light to fit almost anywhere and be used for virtually any lighting application.

RUGGED STYLING DURABLE CONSTRUCTION

Pro Armor® lights are designed to be big and beefy with an aggressive style all their own. Housed in IP67 marine-grade rated UV polyester powdercoated with precision-cast end panels and oversized, extruded aluminum heat sinks to keep the temperature down.

EXCLUSIVE OPTICS

Counting up to 66 3-5 watt CREE® LEDs, Pro Armor® builds bright lights designed for any riding experience. All that power is directed through heat-dissipating aluminum printed circuit boards for streamlined heat management.

DUAL-ROW LED LIGHT BARS

For the most spread and the farthest illumination downrange, Pro Armor® Dual-Row Light Bars are easy to mount and perform beyond expectations. Choose from several lengths and configurations.

SINGLE-ROW LED LIGHT BARS

Powerful and compact, these low-profile light bars look sleek and let you light up the night. Choose from several lengths and configurations to extend your ride.

CUBE LED LIGHTS

Small and powerful, these cube lights can be mounted in strategic locations for added illumination.

8 BEAM PATTERNS

Select from 15 to 90 degrees—the pattern changes when and how you want.

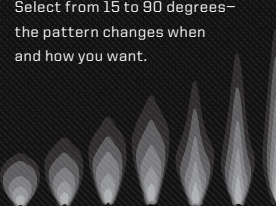

BEAM ADAPTS TO ANY SITUATION

10" ADAPT™	D-SERIES DRIVING	D-SERIES FLOOD	D-SERIES SPOT	SR-SERIES 32"	SR-SERIES 10" SPOT	SR-SERIES 10" FLOOD	SR-SERIES 10" COMBO
RAW LUMENS: 7360	RAW LUMENS: 4752	RAW LUMENS: 3168	RAW LUMENS: 3168	RAW LUMENS: 20,064	RAW LUMENS: 7920	RAW LUMENS: 7920	RAW LUMENS: 7920
2883125	2883128	2883126	2883127	2883124	2883121	2883122	2883123
Available Fall 2017	Comes in a pair	Comes in a pair	Comes in a pair				

DUAL-ROW 30" COMBO	DUAL-ROW 20" COMBO	DUAL-ROW 10" FLOOD	DUAL-ROW 10" SPOT	SINGLE-ROW 11" FLOOD	SINGLE-ROW 11" SPOT	SINGLE-ROW 33" COMBO	SINGLE-ROW 40" COMBO	DUAL-ROW CUBE FLOOD	DUAL-ROW CUBE SPOT
RAW LUMENS: 20064	RAW LUMENS: 9000	RAW LUMENS: 3020	RAW LUMENS: 3060	RAW LUMENS: 1660	RAW LUMENS: 1600	RAW LUMENS: 5350	RAW LUMENS: 7000	RAW LUMENS: 1300	RAW LUMENS: 3060
2882074	2883107	2882311	2882075	2882313	2882078	2882077	2882763	2882312	2882076

⚠️ WIRING HARNESSES REQUIRED FOR INSTALLATION OF RIGID® & PRO ARMOR® LIGHTS

LEARN MORE ABOUT POLARIS PULSE ON P. 86

2018 RANGER XP® 1000 WITH POLARIS PULSE™

Battery Connection Cable factory installed on RANGER XP® 1000 '18

ROOF MOUNTED LIGHTS

1 LIGHT WITH 1 SWITCH

- Roof (2882911, 2882912, 2882913) - See p. 18
- Polaris Pulse™ Roof 6 • 2882904
- Polaris Pulse™ Wiring Harness - 1 LED Light Bar • 2883230

2 LIGHTS WITH 1 SWITCH

- Roof (2882911, 2882912, 2882913) - See p. 18
- Polaris Pulse™ Roof 6 • 2882904
- Polaris Pulse™ Wiring Harness - 1 LED Light Bar • 2883230
- Y-Harness • 2879860

FRONT BUMPER MOUNTED LIGHTS

1 LIGHT WITH 1 SWITCH

- Polaris Pulse™ Wiring Harness - 1 LED Light Bar • 2883230

2 LIGHTS WITH 1 SWITCH

- Polaris Pulse™ Wiring Harness - 1 LED Light Bar • 2883230
- Y-Harness • 2879860

OTHER RANGER®

BATTERY CONNECTION CABLES

- Full-Size 2/3 Seat • 2879388
- Full-Size Crew • 2879685
- Mid-Size 2 Seat • 2879990
- Mid-Size Crew • 2880929

1 LIGHT WITH 1 SWITCH

- LED Harness • 2882209

2 LIGHTS WITH 1 SWITCH

- LED Harness • 2882209
- Y-Harness • 2879860

POLARIS ENGINEERED™
ADVANTAGES

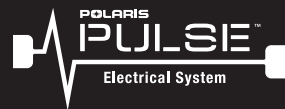

ELECTRICAL INSTALLS
MADE EASY

POLARIS PULSE™ IS A REVOLUTIONARY way to provide additional power locations on your vehicle, and makes adding electrical accessories a snap. Installation of any accessories – such as light bars, dome lights or audio are easier to install on the roof or cab by eliminating the need to run wires through the hood area or through the vehicle cage.

- To install accessories, simply plug the harness into the Polaris PULSE™ hub
- No need to remove nuts and stack wire terminals like a three-post terminal setup
- Using the Polaris PULSE™ plug in place of ring terminals removes the opportunity for arching, unlike a three-post terminal setup
- By plugging in your accessories, a secure connection is guaranteed every time

LOOK FOR THE POLARIS PULSE™ LOGO THROUGHOUT THE CATALOG IDENTIFYING POLARIS PULSE™ READY ACCESSORIES.

POLARIS ENGINEERED™ LIGHTS



WORK BEACON LED LIGHT *NEW*

- 15.2 m of illumination 360° around your vehicle
- Ideal for plowing, hunting and nighttime utility work
- Break-away construction protects the light in areas with tight clearance
- Mounted to the vehicle on the rear of the ROPs
- Easily hinge the light up during use and hinge it down when in transit

» 2883265
AVAILABLE FALL 2017



ACCENT LIGHTING

- Kit includes four LEDs and all harnessing/switching required
- Single light can be added on to the kit (kit required)
- Durable off-road ready construction that is both dust- and water-resistant
- Control hub and complete instructions included

COLOR	LIGHTING KIT	SINGLE LIGHT
RED	2880500 •	2880532 •
BLUE	2880506 •	2880533 •
WHITE	2881119 •	2881176 •
GREEN	2882378 •	2882379 •

ALL RANGER® MODELS, EXCEPT XP 1000 '18 PRODUCTS

POLARIS® INTERACTIVE DIGITAL DISPLAY 2.0

FEATURES

- Exporting capabilities for created tracks and waypoints from the display to USB drive
 - Course-up arrow option with rotating background map now available
 - Distance to a selected waypoint shown on the map screen
 - Automatic day/night brightness change based on time of day and day of year
 - New riding screen with increased visibility of important diagnostics
 - Gear indicator enlarges on gear change
 - High resolution, 4.3" full color LCD display
 - Bluetooth® connectivity allows you to pair your smartphone and check missed calls, text messages, battery life and signal strength
 - GPS connectivity offers exact location information including elevation, latitude/longitude and compass bearings
- » 2881554
XP 1000 '17, XP 900 '13-18, XP 570 '16, DIESEL '14-18, 570 FULL-SIZE '15, CREW XP 1000 & 900 '13-18, CREW XP 570 '16, CREW DIESEL '14-18, CREW 570 FULL-SIZE '15
REQUIRES RANGER® install kit (2880567)
EXTENSION HARNESS REQUIRED FOR CREW (2413116)



Connect your device and play your favorite songs



Check missed calls and text messages without pulling out your phone



Diagnostics screen displays fault codes and suggested actions to take

POLARIS® INTERACTIVE DIGITAL DISPLAY INSTALL KIT

- Includes all-new instrument panel, necessary mounting hardware, wiring harness, etc. to install the Polaris® Interactive Digital Display
- » 2880567
XP 1000 '17, XP 900 '13-18, XP 570 '16, DIESEL '14-18, 570 FULL-SIZE '15, CREW XP 1000 & 900 '13-18, CREW XP 570 '16, CREW DIESEL '14-18, CREW 570 FULL-SIZE '15

AUXILIARY BATTERY KIT

- Recommended to use up to two batteries
- » 2880555
EV '15-18, EV LI-ION '18, EV LI ION '16



EV QUICK CHARGING KIT

- » 2880556
EV '15-18, EV LI-ION '18, EV LI ION '16



DIESEL BLOCK HEATER

- Provides heat to the engine for sure starting in extreme cold
 - Includes thermostat for auto shut-off to prevent overheating
- » 2880826
DIESEL '14-18, CREW XP 900 '15, CREW DIESEL '16-18

EPS (ELECTRONIC POWER STEERING) KIT

- Enjoy smooth, responsive, automotive-quality power steering
- » 2880083
XP 900 '13-18, XP 570 '15-16, XP 1000 '17, XP 1000 HL '18, CREW XP 900 '14-18, CREW XP 570 '15-16, CREW XP 1000 '17-18
- » 2879970
CREW 570-4 '15-18, 570 '15-18, 500 '17-18

SPEEDKEY

- » 2879988
XP 900 '14-18, XP 570 '15-16, XP 1000 '17-18, XP 1000 HL '18, ETX '15-16, CREW XP 900 '14-18, CREW XP 570 '15-16, CREW XP 1000 '17-18, CREW 570-4 '15-18, 570 '15-18, 500 '17-18



SPECIFIC NEEDS, SPECIFIC OILS

Polaris® invests millions in engine development, and part of that investment is making sure its lubricants—critical to engine performance—are the right formula for your specific engine. The amount of testing data and engineering resources used in developing Polaris® lubricants would overwhelm an aftermarket company. Therefore, the aftermarket must spec an oil to an industry-wide standard that must account for a variety of operating parameters.

PS-4 is designed specifically for Polaris® 4-cycle engines and has high film strength and wear protection under extreme loads and temperatures. Exclusive anti-wear additives protect engine parts with extra rust and corrosion protection.

PS-4 FULL-SYNTHETIC OIL

- PS-4 is optimal for ambient operating temperatures of -40° C to 38° C
- » .95 L • 2876244
- » 3.8 L • 2876245
- » 60.6 L • 2876247
- » 208 L • 2876246
- » 1249 L • 2878814

PS-4 OIL CHANGE KIT

- Contains the correct amount of oil for your vehicle and correct oil filter
- » 2202166
SINGLE 570, TWIN 600, TWIN 700, TWIN 800
- » 2879323
RANGER®/RZR® 900/1000
- » 2880913
POLARIS ACE®/ETX 325
- » 2877473
330-500, SPORTSMAN® 550/850/1000

15W40 SUMMER DIESEL ENGINE OIL

- » .95 L • 2882515

ORV MAINTENANCE KIT

- Includes: 1.4 L AGL, .95 L Angle Drive Fluid, .5 L Demand Drive Fluid, 29.5-88.7 mL tube of All-Season Grease
- » 2880425

PS-4 EXTREME-DUTY FULL-SYNTHETIC OIL

- PS-4 Extreme Duty is optimal for ambient operating temperatures of -18° C to 54.4° C
- » 60.6 L • 2879003
- » 208 L • 2879002
- » 1249 L • 2879001
- » .95 L • 2878920
- » 3.8 L • 2878919

PS-4 EXTREME-DUTY OIL CHANGE KIT

- Contains the correct amount of oil for your vehicle and correct oil filter
- » 2879004
SINGLE 570, TWIN 600, TWIN 700, TWIN 800
- » 2878924
330-500, SPORTSMAN® 550/850/1000
- » 2879324
RANGER®/RZR® 900/1000
- » 2881697
RZR TURBO

5W40 ALL-SEASON DIESEL ENGINE OIL

- » .95 L • 2879832
- » 3.8 L • 2881083

POLARIS® PS-4

ULTIMATE ENGINE PROTECTION

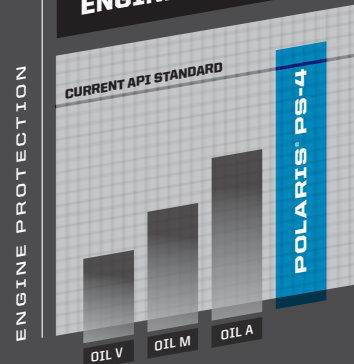

Polaris® PS-4 oils exceed the latest industry protection standard as set by the API. Our proprietary additives clean and protect critical engine parts under high operating temperatures.

33% MORE CAMSHAFT PROTECTION

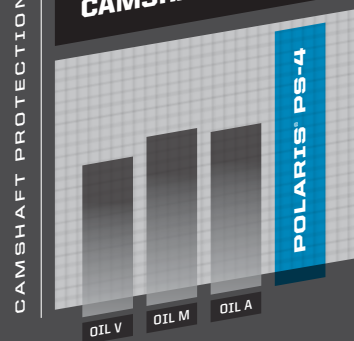

When tested against competitive oils, camshaft bearing races and lobes exhibit less wear when protected by Polaris® PS-4 oil.

25% BETTER PROTECTION AT HIGH TEMPS

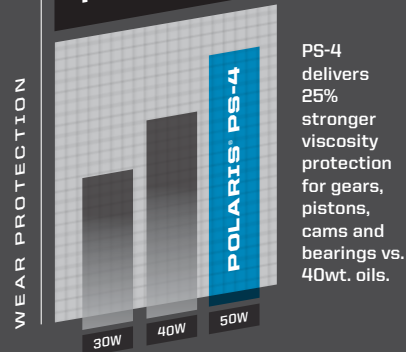

WHY VISCOSITY MATTERS: Polaris® engines are designed to operate using oils rated at a specific viscosity. Viscosity is the measure of an oil's resistance to flow and shear and a way to gauge an oil's "film strength", which is a critical component in preserving engine life when an oil is subject to high heat or heavy loads.

ENGINEERED TO MAXIMIZE THE LIFE OF YOUR RIDE

All Polaris® fluids—from anti-freeze to brake fluid—are developed for your vehicle. Trust the only fluids perfectly engineered for your needs.

AGL

A proprietary blend of additives designed to optimize Polaris® ORV transmission life. Extreme pressure additives protect gears, drive chain and bearings from scoring and wear. Unlike typical gear case oils, AGL's unique viscosity range allows instant flow and film protection in extreme cold or high heat environments

- » .95 L • 2878068
- » 3.8 L • 2878069
- » 9.5 L • 2878070
- » 208 L • 2879594

Proper lubricant application and timing will ensure optimal vehicle performance. Please refer to your owner's manual for lubricant change interval schedules.

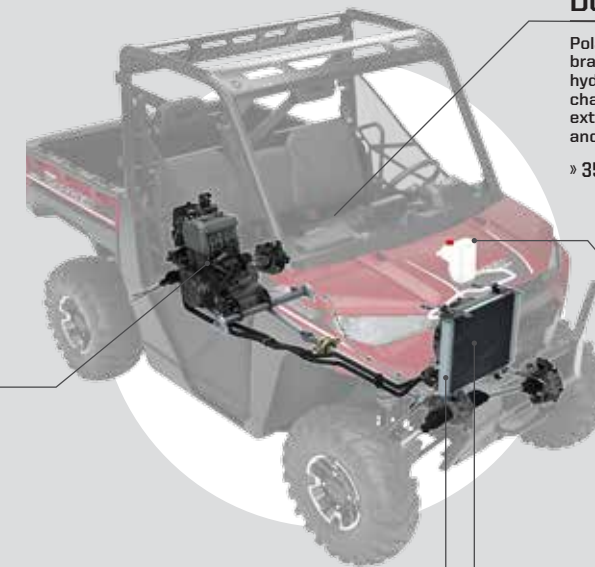

DOT 4 BRAKE FLUID

Polaris® DOT 4 Brake Fluid is a high-quality hydraulic brake fluid designed for use in Polaris® hydraulic brakes. Superior high-temp characteristics plus anti-corrosive additives extend the life of brake system components and provide consistent, positive braking

- » 355 ML • 2872189

ANTI-FREEZE

Polaris® Extended Life Coolant contains organic acid technologies to prevent corrosion on metal components, eliminate scaling and maximize cooling system performance

- » .95 L • 2880514
- » 9.5 L • 2880513
- » 208 L • 2880512

U-JOINT GREASE

Polaris® U-Joint Grease is a heavy-duty lubricant formulated with molybdenum disulfide to accept the high shock applications of Polaris® ATV shaft drive universal joints

- » 88.7 ML • 2871515
- » 414 ML • 2871551

DEMAND DRIVE FLUID

Engineered specifically for Polaris® ORV front drive systems. Provides positive 4WD engagement in extreme cold or high heat conditions. Unique friction additives protect internal components under heavy loads and promote positive engagement

- » .95 L • 2877922
- » 9.5 L • 2877923

LUBE ACCESSORIES



GREASE GUN KIT

- » 2871312

FITS 2871322 ALL-SEASON AND 2871322 U-JOINT 88.7 ML

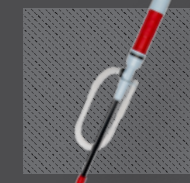

20 BATTERY-OPERATED SIPHON PUMP

- Liquid transfer pumps 4.7-5.7 L/min suctioning power
- Use with gas, water, oil, and other non-corrosive liquids
- » 2830513



FLEX SPOUT

- Convenient easy pour flex spout fits all Polaris® quart, gallon and 9.5 L bottles
- » 2871285



PUMP

- » 2870465
- ATTACHES TO 3.8- OR 9.5- LITER BOTTLE FOR EASY, NO-DRIP DISPENSING



PREMIUM GAS SHOCK OIL

- » .95 L • 2870995
- » 9.5 L • 2872279
- FOX® REBUILDABLE SHOCKS



10WT GAS SHOCK OIL

- » .95 L • 2874124
- WALKER EVANS® REBUILDABLE SHOCKS



ANGLE DRIVE FLUID

- » .95 L • 2876160
- » 9.5 L • 2872276
- SPORTSMAN®, RANGER®, RZR® ANGLE DRIVE GEAR CASE SYSTEMS



CHAIN LUBRICANT

- » 473 ML AEROSOL 2872348



ALL-SEASON GREASE TUBE

- » 88.7 ML • 2871322
- » 473 ML • 2871423



CARBON CLEAN

- Polaris® Carbon Clean prevents ethanol corrosion, stabilizes fuel, cleans fuel injectors, piston ring lands, intake systems and combustion chambers. Helps maintain peak HP and improves fuel economy
- » 355 ML • 2881413



ADVANCED FUEL TREATMENT

- Advanced Fuel Treatment prevents ethanol corrosion and stabilizes fuel for up to 2 years. Dual-antioxidant formula protects against gum and varnish for easy starting
- » 355 ML • 2881416
- » 9.5 L • 2881417



SCENTED ADVANCED FUEL TREATMENT

- 29.5 mL pouch treats 18.9 liters of fuel
- Scented formulas provide pleasant fragrance through the exhaust system
- Alcohol free; safe for all powerports applications
- » MINT • 2881418
- » STRAWBERRY • 2881419
- » UNSCENTED • 2881420
- » 25 - 29.6 ML POUCHES OF EACH FORMULA • 2881421

FOR THE LIFE OF YOUR RIDE

THE KEY TO KEEPING YOUR POLARIS® OFF-ROAD VEHICLE PERFORMING

as well as the day you brought it home is proper maintenance. Items like belts, filters and batteries represent only a few of these critical items engineered specifically by Polaris®.

POLARIS ENGINEERED™ DRIVE BELTS

Polaris Engineered™ belts deliver unmatched performance for your off-road vehicle. Our belts are developed and tested on all our engines for all environments and conditions. This ensures it doesn't merely fit your vehicle—it outperforms your expectations.



TESTED, PERFECTED

We test each belt on the intended vehicle – we don't try to make an existing belt "just work." The tolerances are tighter than aftermarket alternatives, meaning less heat for your engine, and you won't have to recalibrate your clutch in order to run at the engine's optimal RPM. Aftermarket belts fluctuate in and out of the optimal power band, which means more wear on your clutch and more maintenance needed to maintain power.

OUR INVESTMENT

We average of field testing and thousands of dyno hours on each engine to ensure the Polaris® drive belt on your machine gives you peak performance with each and every ride.

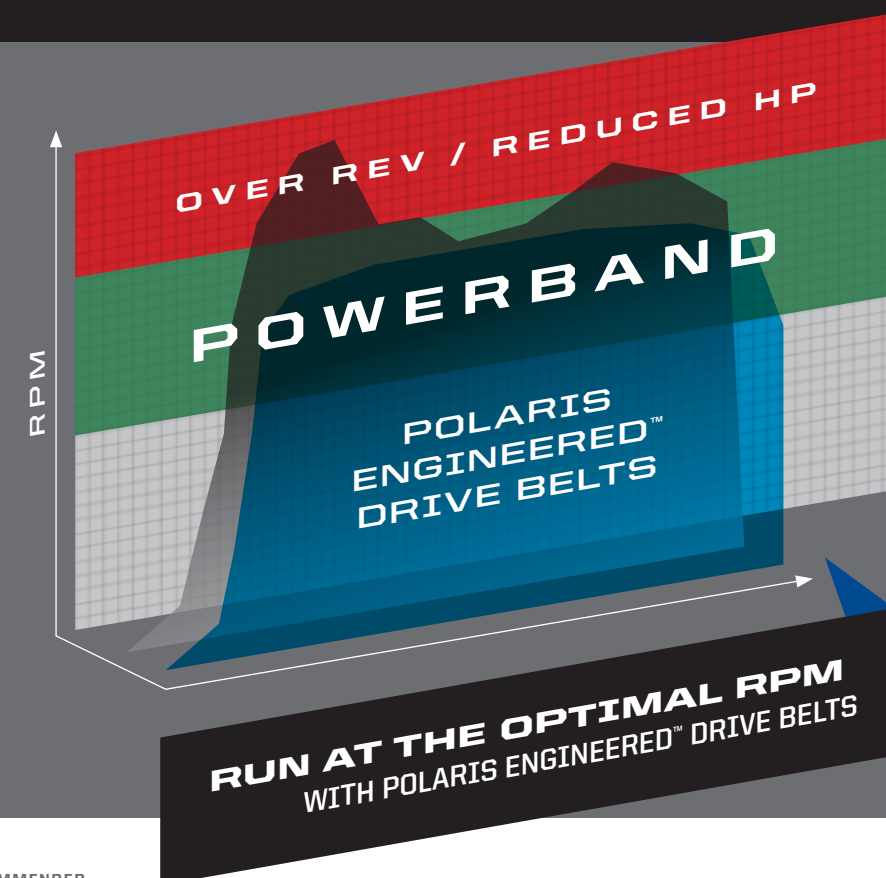

MAINTENANCE SCHEDULE

CHECK YOUR OWNER'S MANUAL FOR ADDITIONAL RECOMMENDED SERVICE ITEMS AND VEHICLE SPECIFIC TIMING

25 HRS/805 KM	100 HRS/1609 KM	150 HRS/2414 KM	200 HRS/3219 KM	350 HRS/5633 KM	500 HRS/8047 KM
BREAK-IN MAINTENANCE	12 MONTHS	18 MONTHS	24 MONTHS	30 MONTHS	36 MONTHS
ENGINE OIL: CHANGE GENERAL LUBRICATION: ALL FITTINGS, PIVOTS, CABLES, ETC. AIR FILTER: INSPECT & CLEAN REPLACE AS NEEDED	ENGINE OIL: CHANGE DRIVE BELT: INSPECT & ADJUST REPLACE AS NEEDED TRANSMISSION FLUID: CHANGE	ENGINE OIL: CHANGE BATTERY: TEST, CLEAN & CHECK FLUID LEVEL REPLACE AS NEEDED DRIVE BELT: INSPECT & ADJUST REPLACE AS NEEDED TIRES: INSPECT CONDITION & PRESSURE	ENGINE OIL: CHANGE BRAKE PADS & FLUID: INSPECT & CLEAN REPLACE AS NEEDED SPARK PLUGS: INSPECT REPLACE AS NEEDED	ENGINE OIL: CHANGE BATTERY: TEST, CLEAN & CHECK FLUID LEVEL REPLACE AS NEEDED DRIVE BELT: INSPECT & ADJUST REPLACE AS NEEDED GENERAL LUBRICATION: ALL FITTINGS, PIVOTS, CABLES, ETC.	ENGINE OIL: CHANGE AIR FILTER: INSPECT, CLEAN REPLACE AS NEEDED COOLANT: CHECK LEVEL REPLACE EVERY 2 YEARS GEARCASES: CHECK OIL LEVEL

POLARIS POWER®

POWERFUL, PORTABLE, DURABLE. These digital inverter generators are built to match your outdoor lifestyle, and are tested to the same rigorous standards as every Polaris® product. The 1000-watt generator is best for running a single device with low wattage requirements. The 2000-watt generator runs multiple devices with added surge protection and start-up wattage. The 3000-watt generator handles high-output needs and runs multiple devices. It also includes electric start for ease of use when needed.

WHICH GENERATOR FITS YOUR NEEDS?

- 1 START** by adding up the running watts of everything you might power at the same time. (Use the chart on below)
- 2 NEXT**, pick the device with the highest running watts, and add its starting watts to the previous total.
- 3 NOW** you have the total amount of watts you need from your generator. Select a generator with a slightly higher wattage.

	Startup Wattage	Running Wattage
55" LCD TV	0	150
CROCK POT	0	200
RADIO	0	50-200
LAPTOP	0	200-250
625W MICROWAVE	0	625
FRIDGE OR FREEZER	700	700
COFFEE MAKER	1300	800
SUMP PUMP: ½ HP	1300	800
BLENDER	1000	1000
ELECTRICAL GRIDDLE	0	1500
7¼" CIRCULAR SAW	1700	1400
AIR CONDITIONER	1500	1500



POLARIS POWER® INVERTER GENERATORS

- » 1000 WATT • P13GDGANA
- » 2000 WATT • P13GDGBNA
- » 3000 WATT • P13GDGCNA



POLARIS POWER® CABLE KIT

- Use a parallel cable kit to easily connect two Polaris Power® generators together to increase the total power available to a load

» 3410281



POLARIS POWER® TIE-DOWN LEADS

- Secure your Polaris Power® Generator by inserting the Lock & Ride® Tie Down Leads into the handle and running a strap across to tie down the generator
- Secures Lock & Ride® accepting gear
- Safely provides a point for 2.5 cm wide tie down strap

» 2880959



POLARIS POWER® COLD WEATHER KIT

- Ensure smooth running of your Polaris® Generator in sub-zero temperatures
- Prevents ice blockage in the crankcase breather tube, which may lead to operational issues including oil leakage
- Installation required, no need to disconnect for warm weather operation
- Exclusively designed for use with Polaris® P1000i & P2000i inverter generators

» 2881433



POLARIS POWER® GENERATOR OIL

- Corrosion inhibitors protect against rust and oxidation during long-term storage

» .95 LITERS • 2879383

POLARIS POWER® GENERATOR STORAGE COVERS

- Keep your generator looking like new with a strong, durable cover that is resistant to mold, mildew, tears and abrasions

» 1000 WATT COVER • 2686441

» 3000 WATT COVER • 2686443

» 2000 WATT COVER • 2686442



POLARIS® FLEX JUMPSTARTER

12,000 mAh capacity. Two 5V/2.1A USB outputs, 200-lumen flashlight and a digital battery life monitor. Includes storage case, smart jumper cables, car charger, wall charger and user guide. 1-year limited warranty.

» 2830495



Never let a dead vehicle battery slow you down again. The Polaris® Flex Jumpstarter is a compact solution that provides the power to get your ride started. Flex is small enough to be stored in your glovebox, and holds its charge so you can count on it when it's needed. In addition to being able to jumpstart ATVs, DRVs, snowmobiles, motorcycles, cars & trucks, Flex can also charge any USB capable device through its dual USB outlets. Flex has the ability to jumpstart up to a 6.4L engine.

BatteryMINDER®

Make sure your vehicle's battery is properly maintained and ready when you need it the most with a BatteryMINDER®. A tired battery is waiting for the perfect time to ruin your day, so make sure it gets charged and cycled properly. Easily one of the most essential pieces of equipment every garage needs.

BATTERYMINDER® 1510 1.5-AMP

- Recovers weak batteries
- Ambient temperature sensor with wide operating range ensures the battery will never be overcharged or undercharged regardless of temperature extremes
- Extends battery life up to four times when compared to new batteries not being properly charged or maintained over their lifetime
- Automatic full-time high frequency (not high voltage) pulse type desulfation
- Reverse polarity, short circuit and over-temperature protection

» 2830404

BATTERYMINDER® 2012 AGM 2-AMP

- Designed for High-Performance Specialty AGM Sealed Batteries
- Guaranteed to never overcharge, regardless of how long connected
- Temperature compensation ensures proper charge in hot or cold environments
- Ambient temperature sensor with wide operating range ensures the battery will never be overcharged or undercharged regardless of temperature extremes
- Maximizes battery life and capacity, reconditions weak batteries

» 2830438



BATTERYMINDER® 1.5 AMP CONVERTIBLE

- BatteryMINDER® 1.5 amp On-board or Benchtop Charger/Maintainer
- Complete with two mounting brackets for multiple vehicles/locations, fully-insulated battery clips and ring terminal-assembly for permanent direct-to-battery attachment.
- Charges, maintains, recovers 12-volt batteries
- Maintains up to four batteries at a time
- Attaches to battery while in vehicle or for use on benchtop
- Guaranteed to never under- or overcharge
- Recovers and reconditions deeply discharged batteries automatically, using high-frequency pulse type desulfation circuitry
- Can extend battery life up to four times

» 2830511

BATTERYMINDER® EZ CONNECT

- Allows for quick and easy connecting and disconnecting of your BatterMINDER®, includes a set of ring terminals

» 2830411

BATTERYMINDER® 3.7 M CABLE

- Made with heavy-duty 16 gauge black zip cord featuring automotive SAE bullet connectors

» 2830410

BATTERYMINDER® SPLITTER

- A simple, safe and affordable way to connect two batteries simultaneously for easy battery maintenance, cap includes a set of ring terminals

» 2830409

BATTERYMINDER® RING TERMINAL

- Features 61 cm long 18-gauge wire
- Plug has standard 5/16" negative and 3/8" positive terminals
- Replaceable 15-amp in-line fuse for circuit protection
- Uses SAE quick connector and cap

» 2830437

TOOL STORAGE SOLUTIONS

1

Give your tools a dedicated spot with a properly sized rolling base. Extra-deep drawers are great for storing power tools and bulky items.

CHOOSE YOUR BASE

Raise-and-release drawer pulls keep drawers secure when moving

Drawers use roller-bearing glides

Full-width wrap-around aluminum drawer pulls



POLARIS® 76 CM 5-DRAWER ROLLER CABINET

• 78cm W x 104cm H x 52cm D
» TEXTURED FINISH 2830406*

Two extra-deep drawers allow storage of large and bulky tools



POLARIS® 104 CM 11-DRAWER ROLLER CABINET

• 104cm W x 105cm H x 46cm D
» TEXTURED FINISH 2830408*
» HIGH-GLOSS FINISH 2830451*



POLARIS® 183 CM 19-DRAWER ROLLER CABINET

• 183cm W x 119cm H x 64cm D
» HIGH-GLOSS FINISH 2830492*

Three extra-long drawers provide storage for tools of all shapes and sizes

2

CHOOSE YOUR TOP



POLARIS® 76 CM PORTABLE WORKSTATION

• 78cm W x 52cm H x 45cm D
» TEXTURED FINISH 2830405*



POLARIS® 104 CM PORTABLE WORKSTATION

• 104cm W x 55cm H x 45cm D
» TEXTURED FINISH 2830407*



POLARIS® 104 CM STANDARD TOP CHEST

• 103cm W x 52cm H x 50cm D
» HIGH-GLOSS FINISH 2830450*

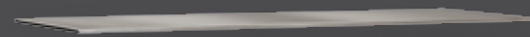

POLARIS® 183 CM STAINLESS STEEL TOP

• 183cm W x 2.5cm H x 64cm D
» 2830496

* Tools not included

DON'T FORGET THE FINISHING TOUCHES

3

UPGRADE



POLARIS POWER® TOOL CADDY

• Hangs from fence rail of roller tool cabinets
» SILVER • 2830430*



POLARIS® HAND TOOL CADDY

» SILVER • 2830431*



POLARIS® BADGES

» RANGER® • 2830413

» RZR® NOT SHOWN 2830412

FINISH YOUR GARAGE



POLARIS® MAGNETIC PARTS TRAY

» SILVER • 2830432

POLARIS® 84 CM TELESCOPIC MAGNET

» BLACK • 2830435



POLARIS® 30.5 CM HI-TORQUE RATCHETING DRIVER

» BLACK / BLUE • 2830434

POLARIS® LED POCKET FLASHLIGHT

» BLACK • 2830436



POLARIS® HEAVY-DUTY SCRUBBER WIPES

» 90 COUNT • 2830441



POLARIS® SHOP TOWELS

» 200 COUNT SHOP TOWEL ROLL WITH DISPENSER 2830402 SHOWN

» 200 COUNT REFILL 2830403

» 64 COUNT SHOP TOWEL REFILL • 2830440

NEW



ROLL IT WHERE YOU NEED IT

Inspired by the carts that top racing teams use, this cart offers the best in storage and portability. Whether in the shop or out in the field, your tools go where you need them the most.

TOOL CART

- Rolling design allows for maximum portability
 - Multiple-depth drawers securely hold hand tools, power tools and more
 - Large tires for performance in all types of terrain
 - Take your tools where you need them easily and securely
- » 79 cm W X 49 cm H X 100 cm D 2830512

ELEVATE YOUR WORK



POLARIS® VEHICLE LIFT

- Get fast, easy access to the underside of your vehicle
- Manual and pneumatic operation available

» 1205 LBS (547 kg)
2830424

- Raises vehicle up to 81.3 cm to make repairs & maintenance faster and easier
- Dual-locking safety latch for added safety

» 2300 LBS (1043 kg)
2830425

POLARIS® VEHICLE LIFT ATTACHMENTS

- » RZR®/RANGER® 2830428
- » ATV/POLARIS ACE® 2830427
- » SNOWMOBILE 2830426



POLARIS® X3 CREEPER

- Three positions: flat, 45-degree angle or seated work stool
- Helps you perform any repair with ease
- Stay dry and warm away from cold, wet cement floors
- Easily stores away when not in use

» BLACK • 2830429

PREMIUM TIRE SEALANT

- Instantly seals and repairs rim, bead leaks and punctures up to 1/4" on standard tires and 3/4" on heavy ply tires
- Helps maintain air pressure for the life of the tire
- Helps seal the tire bead against the wheel
- 100% water soluble for easy cleanup
- Will not rust, corrode or pit wheels
- Creates permanent repair
- Remains fluid and effective in temperatures down to -43° C
- Easily installed through existing tire valve stem with valve core removed

» .95 L • 2830484

» 3.8 LITERS • 2830485

» 18.9 LITERS • 2830486

» 18.9 LITER PUMP • 2830487

» 208 LITERS • 2830489

» 1041 LITERS • 2830488

HOW IT WORKS

Tire sealant remains liquified inside your tire until a leak develops in the tire or wheel.

Once a leak occurs, the tire sealant rushes out of the tire and quickly creates a permanent, solid plug.

The permanent solid plug maintains the pressure of the tire so you can continue your ride.

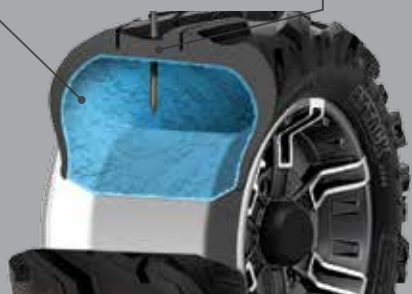

KEEP IT CLEAN

PRE-TREAT

MUD SHIELD® PRE-TREATMENT

- Inhibits the adhesion of dirt, mud and snow, making cleaning your vehicle faster and easier.
- » 473 ML AEROSOL

NEVER RUST SPRAY®

- Synthetic formula highly resistant to water protects against rust and corrosion while lubricating metal surfaces.
- » 473 ML AEROSOL

CLEAN

XP WASH®

- Foaming, highly concentrated wash easily removes the most stubborn and intense dirt build-up.
- » 946 ML

XP SPRAY WASH®

- Effortless biodegradable, high-performance wash ideal for removing dirt, oils and carbon—simply spray on, spray off and go.
- » 946 ML

ALL-PURPOSE CLEANER

- Professional-grade, non-streak, foam formula cuts through grease, dirt and film leaving an invisible, dirt-resistant barrier for long-lasting results.
- » 473 ML

GLASS CLEANER

- Heavy-duty foam non-streak formula cuts through grease, dirt, dried bugs and film, leaving a crystal-clear dirt-resistant barrier for long-lasting results.
- » 473 ML

SHINE

POLARIS® POLISH

- Easy protection and shine—spray on, wipe off and go. For ideal use on painted and plastic surfaces. Contains carnauba wax.
- » 473 ML

INSTANT SHINE & DETAILER

- Spray and wipe formula—cleans, polishes and protects plastic and painted surfaces.
- » 473 ML

TRAILERING



RampPro BY CALIBER®

- Designed for ATVs and UTVs up to 127 cm wide
- Integrated grip glides for ultimate traction
- Sides fold for compact transportation
- » 132 cm x 229 cm • 2883005

ALUMINUM ARCHED LOADING RAMPS

- » 2,000 LB. (907 KG) CAPACITY • 193 CM x 30.5 CM • 2875384
- » 3,000 LB. (1361 KG) CAPACITY • 224 CM x 30.5 CM • 2875386

LIGHTWEIGHT TRI-FOLD RAMPS

- Ramp folds up for transport
- Capacity up to 1,500 lb. (680.7 kg)
- Safety straps included
- » 183 CM x 130 CM • 2875385
- » 208 CM x 130 CM • 2875860

FOLDING ALUMINUM ARCHED RAMPS

- Ramp folds up for transport
- Capacity up to 1,500 lb. (680.7 kg)
- Safety straps included
- » 224 CM x 30.5 CM • 2875387

RECEIVER HITCH

- » 2" (5 cm) RECEIVER • 2875320
- » FRONT HITCH RECEIVER • 2878846



TRAILER BALL 3/4" SHANK

- » 1 7/8" • 2877602
- » 2" • 2877603



TIE-DOWN RATCHET STRAPS

- 1 1/2" (3.8 cm) shockstrap ratchet with safety strap
- » 2859047-01 • RED
- » 2859047-02 • BLACK



TRAILERING COVERS BY POLARIS®

- » 2880632
570 '15-18, ETV '15-18, EV '15-18, EV LI-ION '18
- » 2880633
CREW 570 '15-18, CREW XP 1000 & 900 '14-18, CREW DIESEL '15-18



- » 2879407-067
XP 1000 & 900 '13-18, 4X4, XP, HD '09-13, 4X4, XP, 2X4 '05-08, XP 570 '15-18, DIESEL '15-18



SHOP CLEANERS

ALL-PURPOSE CLEANER PLUS

- Professional-grade formula removes built-up stains from shop floors, work benches and other hard surfaces. VOC-free, environmentally-friendly and biodegradable.
- » 3.8 L • 2830414
- » 18.9 L • 2830416

VEHICLE & EQUIPMENT WASH

- Concentrated, professional-grade formula powers through vehicle buildup, dirt and grease with a spot-free rinse. Treat up to 121 liters. Biodegradable.
- » 3.8 L • 2830417
- » 18.9 L • 2830422

HD CLEANER & DEGREASER

- Professional-grade, biodegradable, high-foaming formula dissolves and removes tough stains and soils.
- » 3.8 L • 2830418
- » 18.9 L • 2830420



POWERED BY
coolcore

Moisture Wicking Moisture Transportation Regulated Evaporation

TENACITY HELMET

- Injection-molded plastic
- 1450 grams
- 14 intake and 8 exhaust vents for airflow
- DOT and ECE Certified
- » 2868624 • PINK XS-2XL

COOLING SHIRTS

- 100% poly, chemical-free patented fabric from CoolCore
- Moisture wicking to keep you dry
- Moisture transportation to keep you cool
- UPF 45+
- » MEN'S • 2868753 GRAY/ORANGE • S-3XL
- » WOMEN'S • 2868755 GRAY/PINK • S-3XL

509° KINGPIN GOGGLE

- Quick-change lens technology
- Contoured triple layer foam
- Premium anti-fog & anti-scratch coatings
- » 2868668 • ORANGE ONE SIZE



509° ALTITUDE CARBON HELMET

- Carbon fiber shell
- 1100 grams
- Fidlock magnet closure
- 8 intake/exhaust vents for airflow
- DOT and ECE2205 Certified
- » 2867814 • BLACK MATTE S-4XL

MEN'S SOFTSHELL JACKET

- Lined with 280 grams of fleece for warmth
- Removable hood
- Pit zips for venting
- » 2868514 • BLACK/ORANGE S-3XL

STAY WARM

509° ALTITUDE HELMET

- Thermo poly alloy shell
- 1260 grams
- 8 intake/exhaust vents for airflow
- DOT and ECE2205 Certified
- » 2868539 • LIME S-4XL

ORV RIDING JERSEY

- 100% poly
- Side mesh panels for venting
- » 2868711 • BLUE/LIME S-3XL

ORV RIDING GLOVES

- Lycra panels provide flexibility in grip
- Soft flex graphics on knuckles for protection
- Lightly padded palm for comfort
- Machine washable
- » 2868712 • BLUE/LIME S-3XL



FORCE HELMET

- Injection-molded plastic
- 1380 grams
- 11 intake and 4 exhaust vents for airflow
- DOT Certified
- » 2868839 • BLUE XS-2XL

MID LAYERS

- Flexible, pill-resistant poly fleece
- Ideal for layering or on its own
- » WOMEN'S • 2868516 BLACK • S-3XL
- » MEN'S • 2868512 BLACK • S-3XL



KEEP YOUR COOL



CAMO TRUCKER CAP

» 2868750 • CAMO • ONE SIZE

HUNTER HOODIE

» MEN'S • 2868716 • OLIVE HEATHER S-3XL
 » WOMEN'S • 2868721 [NOT SHOWN] OLIVE HEATHER • S-3XL

CAMO HOODIE

» WOMEN'S • 2867898 • CAMO S-3XL
 » MEN'S • 2867879 [NOT SHOWN] CAMO • S-3XL



'MERICA RETRO CAP

» 2867757 • BLUE/RED • ONE SIZE

MEN'S RETRO TEE

» 2868571 • GRAY • S-3XL

WOMEN'S RETRO CAP

» 2868617 • GRAY • ONE SIZE

WOMEN'S 3/4 BASEBALL TEE

» 2868584 • GRAY/PINK • S-3XL



MEN'S RETRO LOGO HOODIE

» 2868577 • GRAY • S-3XL



MEN'S ROSEAU HOODIE

» 2868576 • OLIVE S-3XL

WOMEN'S RETRO HOODIE

» 2868592 • BERRY S-3XL



WOMEN'S ASYMMETRICAL HOODIE

» 2868596 • BERRY S-3XL

WOMEN'S V-NECK SCRIPT TEE

» 2868588 • GRAY S-3XL



HEX CAP

» 2867766 • BLACK • ONE SIZE

MEN'S EST TEE

» 2868570 • BLACK • S-3XL

MEN'S HEX TEE

» 2868568 • NAVY • S-3XL

WOMEN'S SCRIPT CREW SWEATSHIRT

» 2868603 • CHARCOAL • S-2XL



WOMEN'S FULL ZIP RETRO HOODIE

» 2868595 • CHARCOAL HEATHER S-3XL



REVERSIBLE CAMO BEANIE

» 2867756 ORANGE/CAMO ONE SIZE

MEN'S CAMO TEE

» 2868757 • CAMO S-3XL

MEN'S TEXTILE RIDING JACKET

» 2867875 • COFFEE S-3XL



CAMO WATER BOTTLE

» 2867962

CAMO COFFEE TRAVEL MUG

» 2867961

CAMO BOTTLE KOOZIE

» 2867964

CAMO CAN KOOZIE

» 2867963

CAMO STEERING WHEEL COVER

» 2868663

CAMO BOTTLE OPENER

[NOT SHOWN]

» 2867965



RETRO CLOCK

» 2868662

PINT GLASS SET OF 2

» 2866265



WOMEN'S ROSEAU TEE

» 2868586 • BLACK • S-3XL

MEN'S MFG CO TEE

» 2868776 • BLACK • S-3XL